









CENU PIEDĀVĀJUMS MĒBEĻU FURNITŪRAI

Svītrkods	Artikuls	Nosaukums	Cena bez PVN	Foto
4750943013228	CB-15	Grozs pilna izvilkuma 2 plaukti 150mm korpusam, sāna vadotnes, hromēts  <i>*Tandem vadotnes</i>	19,932	
4750943013235	C-20	Grozs pilna izvilkuma 3 plaukti 200mm korpusam, sāna vadotnes, hromēts	18,775	
4750943013242	C-30	Grozs pilna izvilkuma 3 plaukti 300mm korpusam, sāna vadotnes, hromēts   <i>*Universāls (labais / kreisais)</i> <i>*Tandem vadotnes</i>	20,644	
4750943013259	CK-30	Grozs pilna izvilkuma 3 plaukti 300mm korpusam, apakšējās vadotnes, hromēts <i>*Gultņu vadotnes</i>	21,441	

4750943013266	G-400	Grozs pilna izvilkuma 400mm korpusam, hromēts	19,820	
4750943013273	G-500	Grozs pilna izvilkuma 500mm korpusam, hromēts	23,960	
4750943013280	G-600	Grozs pilna izvilkuma 600mm korpusam, hromēts	27,260	
		 <p>*Gultņu vadotnes</p>		
4750943014409	G-100	Fasādes kronšteins groziem (2 gab.)	1,754	
		Fasādes kronšteini nepieciešami G-400 / G-500 / G-600 groziem		
4750943014386	G-54-L	Stūra grozs labais, hromēts	75,000	
4750943014393	G-54-K	Stūra grozs kreisais, hromēts	75,000	
4750943013297	GM-300	Grozs pilna izvilkuma 6 plaukti 300mm korpusam, 250 x 450 x (1680 ~ 2175), hromēts	81,525	
4750943013303	GM-400	Grozs pilna izvilkuma 6 plaukti 400mm korpusam, 350 x 450 x (1680 ~ 2175), hromēts	84,746	
4750943013310	R2-15-CR	Grozs CARGO 150mm korp. nepilna izvilkuma 2 pl., hromēts	14,831	
4750943013327	R2-20-CR	Grozs CARGO 200mm korp. nepilna izvilkuma 2 pl., hromēts	18,220	
4750943013334	R2-30-CR	Grozs CARGO 300mm korp. nepilna izvilkuma 2 pl., hromēts	19,915	
4750943013341	R2-40-CR	Grozs CARGO 400mm korp. nepilna izvilkuma 2 pl., hromēts	25,000	
4750943013358	R2-50-CR	Grozs CARGO 500mm korp. nepilna izvilkuma 2 pl., hromēts	27,966	
		*Rullīšu vadotnes		
4750943013365	R3-15-CR	Grozs CARGO 150mm korp. nepilna izvilkuma 3 pl., hromēts	16,737	
4750943013372	R3-20-CR	Grozs CARGO 200mm korp. nepilna izvilkuma 3 pl., hromēts	19,339	
4750943013389	R3-30-CR	Grozs CARGO 300mm korp. nepilna izvilkuma 3 pl., hromēts	21,271	
4750943013396	R3-40-CR	Grozs CARGO 400mm korp. nepilna izvilkuma 3 pl., hromēts	25,381	
		*Rullīšu vadotnes		

4750943013402	G2-15-CR	Grozs CARGO 150mm korp. pilna izvilkuma 2 pl., hromēts	16,186	
4750943013419	G2-20-CR	Grozs CARGO 200mm korp. pilna izvilkuma 2 pl., hromēts	19,449	
4750943013426	G2-30-CR	Grozs CARGO 300mm korp. pilna izvilkuma 2 pl., hromēts	21,780	
4750943013433	G2-40-CR	Grozs CARGO 400mm korp. pilna izvilkuma 2 pl., hromēts	26,907	
4750943013440	G2-50-CR	Grozs CARGO 500mm korp. pilna izvilkuma 2 pl., hromēts	30,169	
*Gultņu vadotnes				

4750943013457	G3-15-CR	Grozs CARGO 150mm korp. pilna izvilkuma 3 pl., hromēts	18,941	
4750943013464	G3-20-CR	Grozs CARGO 200mm korp. pilna izvilkuma 3 pl., hromēts	21,441	
4750943013471	G3-30-CR	Grozs CARGO 300mm korp. pilna izvilkuma 3 pl., hromēts	23,237	
4750943013488	G3-40-CR	Grozs CARGO 400mm korp. pilna izvilkuma 3 pl., hromēts	29,576	
*Gultņu vadotnes				

4750943013495	15-2-45-CR	Grozs 45°, 150mm korp. sānu vad. pilna izvilk. 2 pl., hromēts	18,941	
*Universāls (labais / kreisais)				
*Gultņu vadotnes				

4750943013501	15-2-90-CR	Grozs 150mm korp. sānu vad. pilna izvilk. 2 pl., hromēts	16,653	
4750943013518	20-2-90-CR	Grozs 150mm korp. sānu vad. pilna izvilk. 2 pl., hromēts	19,025	
*Universāls (labais / kreisais)				
*Gultņu vadotnes				

4750943013525	15-3-90-CR	Grozs 150mm korp. sānu vad. pilna izvilk. 3 pl., hromēts	21,992	
4750943013532	20-3-90-CR	Grozs 200mm korp. sānu vad. pilna izvilk. 3 pl., hromēts	26,229	
*Universāls (labais / kreisais)				
*Gultņu vadotnes				

4750943013549	300-45-K	Grozs 300/45 korp. sānu st. 3 pl. pilna izvilkuma, kreisais	44,068	
4750943013556	300-45-P	Grozs 300/45 korp. sānu st. 3 pl. pilna izvilkuma, labais	44,068	
*Gultņu vadotnes				

4750943013563	WE19-2-B	Grozs 235x485x485 sānu vad. pilna izvilk. 2 pl., balts	10,456	
4750943013570	WE19-2-P	Grozs 235x485x485 sānu vad. pilna izvilk. 2 pl., pelēks	11,345	
*Gultņu vadotnes				

4750943013587 4750943013594	WE19-3-B WE19-3-P	Grozs 235x485x485 sānu vad. pilna izvilk. 3 pl., balts Grozs 235x485x485 sānu vad. pilna izvilk. 3 pl., pelēks *Gultņu vadotnes		
4750943013600 4750943013617	WE-11-B WE-11-P	Miskaste izvelkama 235x485x485 viens spainis, balta Miskaste izvelkama 235x485x485 viens spainis, pelēka *Pilna izvilkuma *Gultņu vadotnes	10,892 12,250	
4750943013624 4750943013631	WE-22-B WE-22-P	Miskaste izvelkama 295x515x325 divi spaiņi, balta Miskaste izvelkama 295x515x325 divi spaiņi, pelēka *Nepilna izvilkuma *Rullīšu vadotnes	13,898 15,085	
2770040033297	TB-12	Miskaste izgriežama 12 litri, nerūsējoša tērauda	10,339	
2770040034348 2770040034355 2770040034362	TB-13 TB-14 TB-15	Miskaste izgriežama 14 litri, pelēka Miskaste izgriežama 14 litri, balta Miskaste izgriežama 14 litri, hromēta	6,398 6,737 8,178	
2770040034546	250GC	Atkritumu konteiners 2 x 14 l , ner.tēr.apvalks	34,297	
2770040034553	503GP	Atkritumu konteiners 2x16l, pelēks INOX	47,797	
2770040034539	231GC	Atkritumu konteiners 2 x 20 l , gaiši pelēks	35,763	

2770040034560	502.12.023	Atkritumu konteiners 15 l , nerūsējošā tērauda	15,890	
---------------	------------	--	--------	--







4750943013648	MD400100	Grozs MD 400mm korp. H-100, balts	6,280	 <p>*Dziļums 475 mm</p> <p>*Rullīšu vadotnes ar regulāciju</p>
4750943013655	MD400100-P	Grozs MD 400mm korp. H-100, pelēks	6,737	
4750943013662	MD400150	Grozs MD 400mm korp. H-150, balts	6,644	
4750943013679	MD400150-P	Grozs MD 400mm korp. H-150, pelēks	7,119	
4750943013686	MD400200	Grozs MD 400mm korp. H-200, balts	6,737	
4750943013693	MD400200-P	Grozs MD 400mm korp. H-200, pelēks	7,254	
4750943013709	MD500100	Grozs MD 500mm korp. H-100, balts	6,644	
4750943013716	MD500100-P	Grozs MD 500mm korp. H-100, pelēks	7,119	
4750943013723	MD500150	Grozs MD 500mm korp. H-150, balts	6,737	
4750943013730	MD500150-P	Grozs MD 500mm korp. H-150, pelēks	7,254	
4750943013747	MD500200	Grozs MD 500mm korp. H-200, balts	6,907	
4750943013754	MD500200-P	Grozs MD 500mm korp. H-200, pelēks	7,483	
4750943013761	MD500300	Grozs MD 500mm korp. H-300, balts	7,924	
4750943013778	MD500300-P	Grozs MD 500mm korp. H-300, pelēks	8,797	
4750943013785	MD600100	Grozs MD 600mm korp. H-100, balts	6,737	
4750943013792	MD600100-P	Grozs MD 600mm korp. H-100, pelēks	7,254	
4750943013808	MD600150	Grozs MD 600mm korp. H-150, balts	6,907	
4750943013815	MD600150-P	Grozs MD 600mm korp. H-150, pelēks	7,483	
4750943013822	MD600200	Grozs MD 600mm korp. H-200, balts	7,119	
4750943013839	MD600200-P	Grozs MD 600mm korp. H-200, pelēks	7,678	
4750943013846	MD600300	Grozs MD 600mm korp. H-300, balts	9,890	
4750943013853	MD600300-P	Grozs MD 600mm korp. H-300, pelēks	11,068	









2770040035116	3010	Reliņa āķis, hromēts (5 gab.)	0,441	
4750943007333	3015	Reliņa āķis, matēts niķelis (5 gab.)	1,017	
4750943007340	3018	Reliņa āķis, matēts hroms (5 gab.)	1,017	



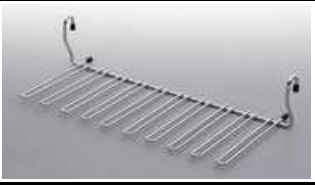





2770040026695	3100	Reliņa stanga Ø16/1,5*1000, hromēta	1,059	
4750943007357	3105	Reliņa stanga Ø16/1,5*1000, niķelēta matēta	1,966	
4750943013860	3108	Reliņa stanga Ø16/1,5*1000, hromēta matēta	1,966	
2770040026688	3600	Reliņa stanga Ø16/1,5*600, hromēta	0,907	
4750943007364	3605	Reliņa stanga Ø16/1,5*600, niķelēta matēta	1,568	
4750943013877	3608	Reliņa stanga Ø16/1,5*600, hromēta matēta	1,568	



2770040021263	3002	Reliņa līkums 90, hromēts	0,653	
4750943007371	3052	Reliņa līkums 90, matēts niķelis	1,441	
4750943013884	3082	Reliņa līkums 90, matēts hroms	1,441	

2770040021256	3003	Reliņa līkums 135, hromēts	0,695	
4750943007388	3053	Reliņa līkums 135, matēts niķelis	1,441	
4750943013891	3083	Reliņa līkums 135, matēts hroms	1,441	

2770040024738 4750943007395 4750943007401	3004 3054 3084	Reliņa turētājs H22 apaļš, hromēts Reliņa turētājs H22 apaļš, matēts niķelis Reliņa turētājs H22 apaļš, hromēts matēts	0,661 1,017 1,017	
2770040024721 4750943007418 4750943007425	3005 3055 3085	Reliņa turētājs H38, taisnstūrainš, hromēts Reliņa turētājs H38, taisnstūrainš, matēts niķelis Reliņa turētājs H38, taisnstūrainš, hromēts matēts	0,831 1,178 1,178	
4750943007432 4750943007449 4750943007456	3006 3056 3086	Reliņa uzgalis retro, hromēts Reliņa uzgalis retro, matēts niķelis Reliņa uzgalis retro, hromēts matēts	0,415 0,593 0,593	
2770040024547 4750943007463 4750943007470	3007 3057 3087	Reliņa uzgalis, hromēts Reliņa uzgalis, matēts niķelis Reliņa uzgalis, hromēts matēts	0,254 0,441 0,441	
2770040021317	3000	Reliņa savienojošā bukse	0,042	
4750943012641	R-01	Reliņa grozs stūra 270x290 H235, hromēts	5,381	
4750943012658	R-02	Reliņa grozs lielais 1st 450x185 H295, hromēts	6,525	
4750943012665	R-03	Reliņa grozs garšvielām 2st 210x80 H310, hromēts	4,873	









4750943012672	R-04	Reliņa grozs vidējais 2st 350x110 H335, hromēts	5,890	
4750943012689	R-05	Reliņa grozs lielais 2st 450x185 H335, hromēts	7,585	
4750943012696	R-06	Reliņa grozs glāzēm lielais, hromēts	4,788	
4750943012702	R-07	Reliņa grozs papīra dvielim un follījai, hromēts	5,551	
4750943012719	R-08	Reliņa grozs 6 pudelēm 270x180 H330, hromēts	8,347	
4750943012726	R-09	Reliņa grozs 3 pudelēm 245x125 H355, hromēts	5,890	
4750943012733	R-10	Reliņu grozs grāmatai 400x230 H485, hromēts	6,441	
4750943012740	R-11	Reliņa grozs traukiem 445x265 H255 ar plastik. pl. hromēts	14,177	
4750943012757	R-12	Reliņa grozs traukiem 445x265 H255 ar inox palikni, hromēts	20,127	



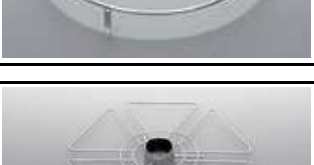
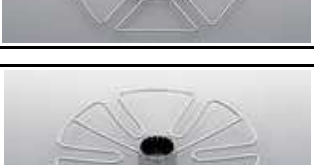

4750943012771	R-14	Reliņa grozs galda piederumiem 112x125 H235, hromēts	6,525	
4750943012788	R-15	Reliņa grozs palīknis 200x265 H40, hromēts	4,449	
4750943012795	R-16	Reliņa grozs katlu vākiem 100x100 H290, hromēts	4,153	
4750943012801	R-17	Reliņa grozs 1st 280x175 H235, hromēts	5,720	
4750943012818	R-18	Reliņa grozs glāzēm 154x200 H100, hromēts	3,517	
4750943012825	R-19	Reliņa grozs 1st ruļļa tur. 250x175 H190, hromēts	4,407	
4750943012832	R-20	Reliņa grozs 1st 210x85 H195 garšvielām, hromēts	4,195	
4750943013907	R-40-140	Reliņu garšvielu trauks 40*140, hromēts (5 gab.)	5,254	
4750943013914	R-57-120	Reliņu garšvielu trauks 57x57 H120, stikla (3 gab.)	2,373	

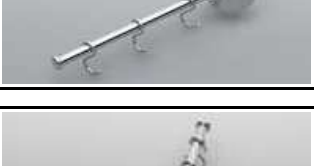
4750943013921	R-21	Reliņa grozs gaļas dēlītim 80x80 H150, hromēts	2,119	
4750943013938 4750943013945	R-M R-L	Reliņa gaļas dēlītis uzkarināms 157x20x227 , dižskabārdis Reliņa gaļas dēlītis uzkarināms 214x20x305 , dižskabārdis	3,347 5,042	

50 mm kolonnas aksesuāri

4750943014416 4750943014423	50-3000 50-1500	50 mm caurule 3 m, hromēta 50 mm caurule 1.5 m, hromēta	12,644 9,254	
4750943014720	KT-50	50 mm kolonnas canga	1,644	
4750943014447	KZ-50	50 mm kolonnas savienotājs	2,331	
4750943014454	MD-50	50 mm kolonnas apakšējais stiprinājums, hromēts	1,568	
4750943014461	MD-55	50 mm kolonnas apakšējais stiprinājums augstais, hromēts	1,822	
4750943014478	ZG-50	50 mm kolonnas uzgalis, hromēts	2,008	
4750943014485	PM-50	50 mm kolonnas gredzens, hromēts	1,822	
4750943014492 4750943014508 4750943014515 4750943014522	S-45 S-115 S-200 S-250	50 mm kolonnas sānu turētājs 45mm, hromēts 50 mm kolonnas sānu turētājs 115mm, hromēts 50 mm kolonnas sānu turētājs 200mm, hromēts 50 mm kolonnas sānu turētājs 250mm, hromēts	2,651 3,176 3,542 3,977	
4750943014539	KMG-50	50 mm kolonnas aukšējais stiprinājums, hromēts	4,746	

4750943014546 4750943014553	PC-350 PC-450	50 mm kolonnas plaukts centrālais D-350, hromēts 50 mm kolonnas plaukts centrālais D-450, hromēts	12,458 14,153	
4750943014560 4750943014577	PK-350 PK-450	50 mm kolonnas plaukts ar kronšt. D-350, hromēts 50 mm kolonnas plaukts ar kronšt. D-450, hromēts	14,153 16,695	
4750943014584 4750943014591	RK-350 RK-450	50 mm kolonnas plaukts ar kronšt. stikla D-350, hromēts 50 mm kolonnas plaukts ar kronšt. stikla D-450, hromēts	19,364 25,381	
4750943014607 4750943014614	RC-350 RC-450	50 mm kolonnas plaukts centrālais stikla D-350, hromēts 50 mm kolonnas plaukts centrālais stikla D-450, hromēts	14,407 18,644	
4750943014621	K-360	50 mm kolonnas plaukts centrālais glāzēm D-360, hromēts	9,280	
4750943014638	K-310	50 mm kolonnas plaukts centrālais glāzēm D-310, hromēts	11,822	
4750943014645	KS-360	50 mm kolonnas plaukts stikla, glāzēm D-360, hromēts	36,356	
4750943014652	P-225	50 mm kolonnas pakarināmais viens zars 225mm, hromēts	7,941	
4750943014669	P-180	50 mm kolonnas pakarināmais trīs zari 180mm, hromēts	10,322	
4750943014676	SD-490	50 mm kolonnas plaukts centrālais 6 pudelēm, hromēts	14,983	





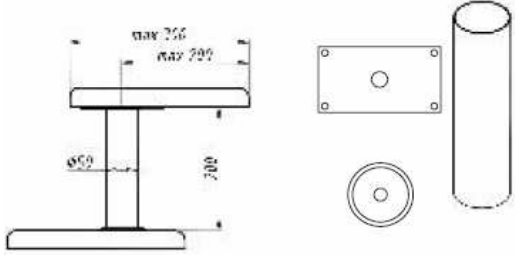
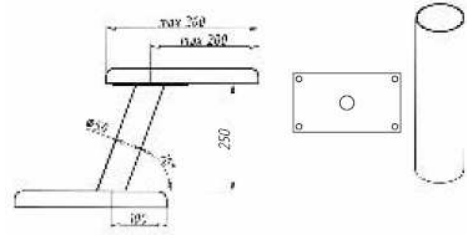
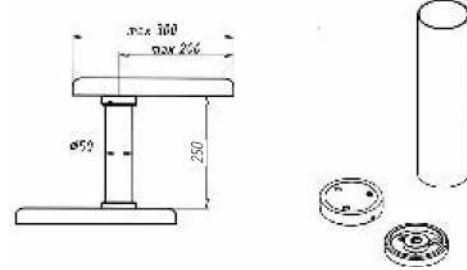





4750943014683	M-01	50 mm kolonnas plaukta turētājs, hromēts	5,254	
4750943014690	M-02	50 mm kolonnas plaukta turētājs dubultais, hromēts	6,542	
4750943014706	K-420	50 mm kolonnas plaukts L-420, hromēts	16,525	
4750943014713	W-350	50 mm kolonnas plaukts centrālais D-350 H-185, hromēts	19,407	

Bāra stiprinājumi

4750943014263	B-001	Bāra letes kronšteins H-250, hromēts	7,415	
4750943014270	B-002	Bāra letes kronšteins slīpais H-250, hromēts	7,415	
4750943014287	B-003	Bāra letes kronšteins H-250, hromēts	11,797	



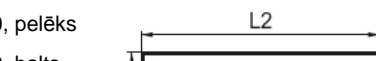



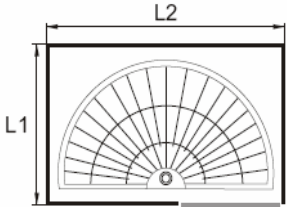
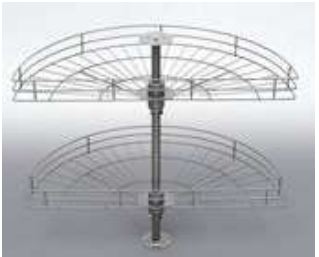

4750943014294	B-004	Bāra letes kronšteins slīpais H-250, hromēts	11,797	
				
4750943014300	B-005	Bāra letes kronšteins H-250, hromēts	12,703	
				
4750943014317	B-006	Bāra letes kronšteins slīpais H-250, hromēts	12,703	
				
4750943014324	B-007	Bāra letes kronšteins alumīnija slīpais H-170, hromēts	9,958	
4750943014331	B-008	Bāra letes kronšteins alumīnija H-170, hromēts	9,958	
4750943014348	W-200	Teleskopiskā atdure 200-280 mm, hrom;eta	13,517	
4750943014355	W-290	Teleskopiskā atdure 290-400 mm, hrom;eta	15,678	
4750943014362	W-410	Teleskopiskā atdure 410-540 mm, hrom;eta	17,576	
4750943014379	W-550	Teleskopiskā atdure 550-700 mm, hrom;eta	19,144	
				

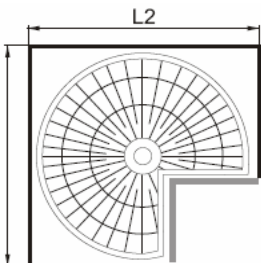
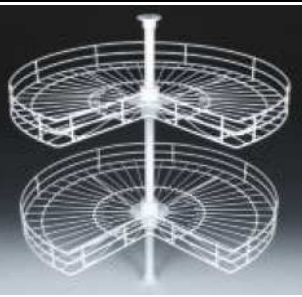
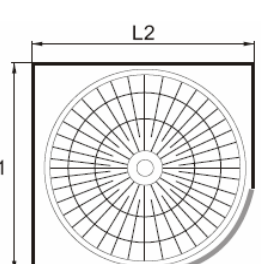
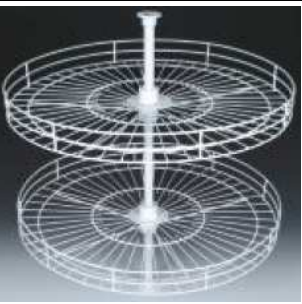
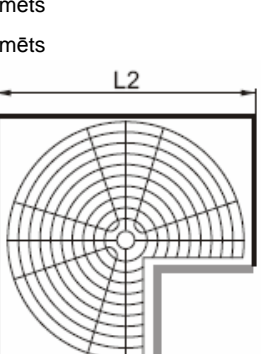
Trauku žāvētavas

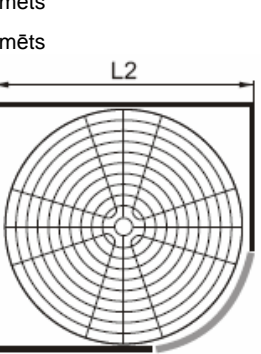
4750943012849	100600	Trauku žāvētava 600 mm, balta	2,473		
4750943012856	100600-P	Trauku žāvētava 600 mm, pelēka	2,800		
4750943012863	100800	Trauku žāvētava 800 mm, balta	2,753		
4750943012870	100800-P	Trauku žāvētava 800 mm, pelēka	3,173		
2770040034171	200400	Trauku žāvētava 400mm, hromēta	6,971		
2770040034188	200500	Trauku žāvētava 500mm, hromēta	7,422		
2770040019987	200600	Trauku žāvētava 600mm, hromēta	8,146		
2770040034195	200700	Trauku žāvētava 700mm, hromēta	8,655		
2770040019994	200800	Trauku žāvētava 800mm, hromēta	9,412		
2770040034201	200900	Trauku žāvētava 900mm, hromēta	11,398		
4750943012887	400600	Trauku žāvētava 1 st. 600 mm, hromēta	10,874		
4750943012894	400800	Trauku žāvētava 1 st. 800 mm, hromēta	11,690		
4750943012900	500600	Trauku žāvētava 600mm ar rāmi, balta	6,126		
4750943012917	500600-P	Trauku žāvētava 600mm ar rāmi, pelēka	7,888		
4750943012924	500800	Trauku žāvētava 800mm ar rāmi, balta	7,006		
4750943012931	500800-P	Trauku žāvētava 800mm ar rāmi, pelēka	8,769		
4750943012948	300600	Trauku žāvētava 600mm ar rāmi, hromēta	12,870		
4750943012955	300800	Trauku žāvētava 800mm ar rāmi, hromēta	13,679		
4750943012962	700600	Trauku žāvētava 600mm, nerūsējošā tērauda	15,847		
4750943012979	700800	Trauku žāvētava 800mm, nerūsējošā tērauda	18,093		

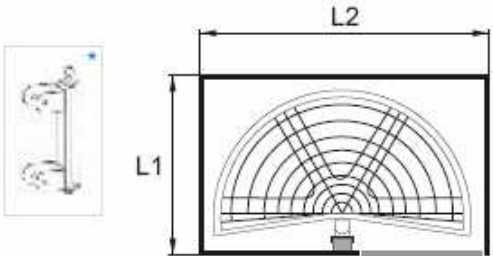
Karuseļu grozi

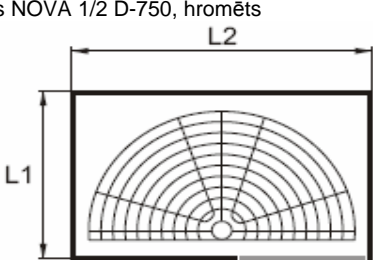

4750943012986	1/2-690-B	Karuseļis 1/2-D690, balts	9,788		
4750943012993	1/2-690-P	Karuseļis 1/2-D690, pelēks	12,373		
4750943013006	1/2-750-B	Karuseļis 1/2-D750, balts	10,169		
4750943013013	1/2-750-P	Karuseļis 1/2-D750, pelēks	13,161		



<p>4750943013020 4750943013037 4750943013044 4750943013051</p>	<p>3/4-690-B 3/4-690-P 3/4-750-B 3/4-750-P</p>	<p>Karuselis 3/4-D690, balts Karuselis 3/4-D690, pelēks Karuselis 3/4-D750, balts Karuselis 3/4-D750, pelēks</p>		<p>10,288 12,669 10,983 13,534</p>	
<p>4750943013068 4750943013075 4750943013082 4750943013099</p>	<p>4/4-690-B 4/4-690-P 4/4-750-B 4/4-750-P</p>	<p>Karuselis 4/4-D690, balts Karuselis 4/4-D690, pelēks Karuselis 4/4-D750, balts Karuselis 4/4-D750, pelēks</p>		<p>14,763 16,551 15,153 16,856</p>	
<p>4750943013105 4750943013112</p>	<p>3/4-690-CR 3/4-750-CR</p>	<p>Karuselis NOVA 3/4 D-690, hromēts Karuselis NOVA 3/4 D-750, hromēts</p>		<p>38,941 41,051</p>	
<p>4750943013129 4750943013136</p>	<p>4/4-690-CR 4/4-750-CR</p>	<p>Karuselis NOVA 4/4 D-690, hromēts Karuselis NOVA 4/4 D-750, hromēts</p>		<p>53,068 56,695</p>	
<p>4750943013143 4750943013150</p>	<p>1/2-690-S-CR 1/2-750-S-CR</p>	<p>Karuselis NOVA sāna 1/2 D-690, hromēts Karuselis NOVA sāna 1/2 D-750, hromēts</p>		<p>37,907 38,780</p>	
<p>4750943013167 4750943013174</p>	<p>1/2-690-CR 1/2-750-CR</p>	<p>Karuselis NOVA 1/2 D-690, hromēts Karuselis NOVA 1/2 D-750, hromēts</p>		<p>37,076 37,203</p>	

Mēbeļu kājas

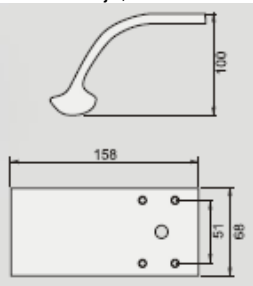
2770040031804	D-01-4	Mēbeļu kāja H 120mm, hromēta	1,229	
2770040031811	D-01-6	Mēbeļu kāja H 120mm, niķelēta mat.	1,313	
4750943007500	D-01-8	Mēbeļu kāja H 120mm, hromēta matēta	1,432	
2770040031828	D-03-4	Mēbeļu kāja H 110mm, hromēta	0,490	
2770040031835	D-03-6	Mēbeļu kāja H 110mm, niķelēta mat.	0,510	
2770040031866	D-712-4	Mēbeļu kāja H 90mm, hromēta	1,208	
2770040031873	D-712-6	Mēbeļu kāja H 90mm, niķelēta mat.	1,313	
2770040031880	D-780-4	Mēbeļu kāja H 110mm, hromēta	1,208	
2770040031897	D-780-6	Mēbeļu kāja H 110mm, niķelēta mat.	1,313	
2770040031927	D-100-4	Mēbeļu kāja H 100mm, hromēta	0,450	
2770040031934	D-100-6	Mēbeļu kāja H 100mm, niķelēta mat.	0,510	
2770040031941	D-150-4	Mēbeļu kāja H 150mm, hromēta	0,470	
2770040031958	D-150-6	Mēbeļu kāja H 150mm, niķelēta mat.	0,560	
2770040031989	D-726-4	Mēbeļu kāja H 130mm, hromēta	1,870	
2770040032016	D-740-8	Mēbeļu kāja H 100mm, hromēta mat.	1,250	
2770040032047	D-727-8	Mēbeļu kāja H 120mm, hromēta mat.	1,350	
2770040032054	D-741-8	Mēbeļu kāja H 100mm, hromēta mat.	1,190	

2770040032092 2770040032108 2770040032115	DAP-77-60 DAP-77-100 DAP-77-150	Mēbeļu kāja H 60mm, alumīnija Mēbeļu kāja H 100mm, alumīnija Mēbeļu kāja H 150mm, alumīnija	0,599 0,811 1,050	
2770040032184 2770040032191 2770040032207	DAKP-27-60 DAKP-27-100 DAKP-27-150	Mēbeļu kāja H 60mm, alumīnija Mēbeļu kāja H 100mm, alumīnija Mēbeļu kāja H 150mm, alumīnija	0,639 0,838 1,080	
2770040032214 2770040032221	D-867 D-869	Mēbeļu kāja H 100mm, alumīnija Mēbeļu kāja H 150mm, alumīnija	1,418 1,628	
2770040023434 2770040023458	D-868 D-868-2	Kāja Ø32 H100 pam.Ø41 anod. Kāja Ø32 H150 pam.Ø41 anod.	1,208 1,470	
2770040023816 2770040033037 2770040032238	DP-100 DP-150 DP-1	Kāja virt.plauktiem h10-13cm plast.melnas Kāja virt.plauktiem h15-183cm plast.melnas Klipsis kājām DP-100/150	0,132 0,154 0,042	
2770040032245	WPJA-22	Mēbeļu kāja H 22mm	0,150	
4750943147411	XH-3058	Mēbeļu kāja H-96, hromēta 	3,212	
4750943147428	XH-3078	Mēbeļu kāja H-132 alumīnija, hromēta 	2,669	

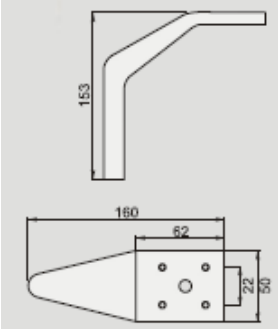
4750943147435	XH-3079	Mēbeļu kāja H-100 alumīnija, hromēta 	3,381	
---------------	---------	--	--------------	--

4750943147442	XH-3094	Mēbeļu kāja H-153 alumīnija, hromēta 	3,263	
---------------	---------	---	--------------	---

4750943147459	XH-8273	Mēbeļu kāja H-20 alumīnija, hromēta	1,924	
---------------	---------	-------------------------------------	--------------	---

Mēbeļu ritentiņi





2770040025131	KM-50	Groz.rit.Ø50*42	0,165	
2770040025148	KM-50-BR	Groz.rit.Ø50mm,42x42ar bremzi	0,184	
2770040025117	KM-40	Groz.rit.Ø40*42	0,135	
2770040033044	KM-40-BR	Groz.rit.Ø40mm,42x42ar bremzi	0,165	

Mēbeļu eņģes

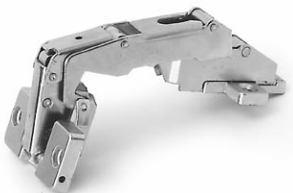

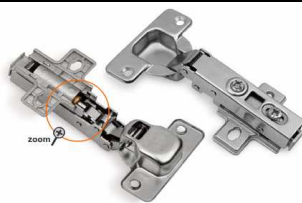

2770040024448	GTV-CN9	Šarnīr v. Ø35/0/04 A 105°vg+paliknis	0,154	
2770040024455	GTV-CN8	Šarnīr v. Ø35/9/04 B 105°vg+paliknis	0,154	
2770040024462	GTV-CN7	Šarnīr v. Ø35/17/04 C 105°vg+paliknis	0,154	

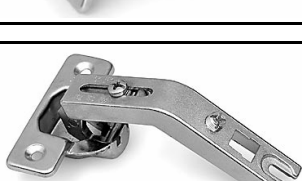
2770040024363	GTV-CI9	Šarnīr v. Ø26h10/0 uzliktās ar palikni	0,132	
2770040024745	GTV-CI8	Šarnīr v. Ø26h10/8 pusuzliktās ar palikni	0,132	
2770040024431	GTV-CI7	Šarnīr v. Ø26h10/17 iekšējā ar palikni	0,132	

2770040023915	GTV-175	Šarnīr v. Ø35/0/01B165° uzlikt ā	0,650	
---------------	---------	----------------------------------	--------------	---

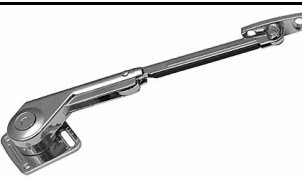
2770040023939 2770040023946	GTV-09 GTV-07	Šarnīr v. Ø35/0 lēnas darbības, uzliktā Šarnīr v. Ø35/17 lēnas darbības, iekšējā	1,050 1,050	
4750943012092	GTV-30	Šarnīr vira Ø35/0/30° ar palikni	0,322	
4750943012108	GTV-45	Šarnīr vira Ø35/0/45° ar palikni	0,322	
4750943012115	GTV-90	Šarnīr vira Ø35/0/90° ar palikni	0,322	
4750943012122	GTV-135	Šarnīr vira Ø35/0/135° ar palikni	0,466	

Mēbeļu durtiņu kronšteini



2770040032252 2770040032269	PH-L PH-P	Mēbeļu durtiņu kronšteins, kreisais Mēbeļu durtiņu kronšteins, labais	2,250 2,250	
2770040033051 2770040023953 2770040033068 2770040033075	PG-50N PG-80N PG-100N PG-120N	Durvju pacēlājs - gāzes cilindrs 50N Durvju pacēlājs - gāzes cilindrs 80N Durvju pacēlājs - gāzes cilindrs 100N Durvju pacēlājs - gāzes cilindrs 120N	2,100 2,100 2,100 2,100	
2770040032276	PM-00	Mēbeļu durtiņu kronšteins, universāls	1,950	
2770040032283 2770040032290 2770040032306	PM-D4 PM-D6 PM-D8	Mēbeļu durtiņu kronšteins, hromēts Mēbeļu durtiņu kronšteins, niķelēts mat. Mēbeļu durtiņu kronšteins, hromēts mat.	2,020 2,020 2,020	

2770040032313	JN-00	Mēbeļu durtiņu kronšteins, JUNIOR	1,050	
4750943147244 4750943147251	SPG-L SPG-K	Mēbeļu durtiņu kronšteins L-225, labais Mēbeļu durtiņu kronšteins L-225, kreisais	0,331 0,331	
4750943147466	AM-03	Mēbeļu magnēts ar adapteri	0,720	
2770040032320 4750943006015	AM-01 AM-02	Amartizātors durtiņām, gāzes Amartizātors durtiņām, gāzes (dubultais)	0,473 0,750	
4750943006022	PML	Mēbeļu durtiņu kronšteins, PML	16,847	
4750943006039	PMS	Mēbeļu durtiņu kronšteins, PMS	15,076	



Mēbeļu atslēdziņas







2770040032337	103	Mēbeļu atslēdziņa	0,520	
2770040032351	201	Mēbeļu atslēdziņa	0,470	
2770040024004	138	Atslēga mēbeļu Ø19x22mm, Ni	0,449	
2770040032382	408	Mēbeļu atslēdziņa stikla durtiņām	0,680	

Izvelkamie pakarināmie

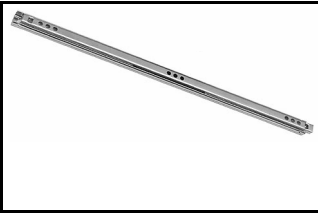
2770040032450	PA-250	Pakarināmais izvelkams L-250 mm	0,550	
2770040032467	PA-300	Pakarināmais izvelkams L-300 mm	0,594	
2770040032474	PA-350	Pakarināmais izvelkams L-350 mm	0,638	
2770040032481	PA-400	Pakarināmais izvelkams L-400 mm	0,660	
2770040032498	PA-450	Pakarināmais izvelkams L-450 mm	0,704	
2770040032504	PA-500	Pakarināmais izvelkams L-500 mm	0,748	
4750943006046	J01-01	Pakarināmais izvelkams kaklasaitēm	3,235	
4750943006053	J01-02	Pakarināmais izvelkams kaklasaitēm	3,235	
4750943006060	J03	Pakarināmais izvelkams biksēm	3,815	
4750943006077	J03A	Pakarināmais izvelkams kaklasaitēm un biksēm	4,241	
4750943006084	PG-45-60	Pantogrāfs 45/60 cm, alumīnija	13,602	
4750943006091	PG-60-83	Pantogrāfs 60/83 cm, alumīnija	14,898	
4750943006107	PG-83-115	Pantogrāfs 83/115 cm, alumīnija	16,051	

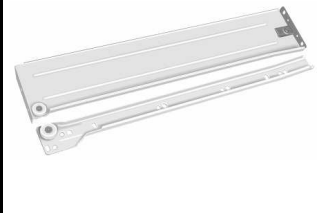
Vadotnes

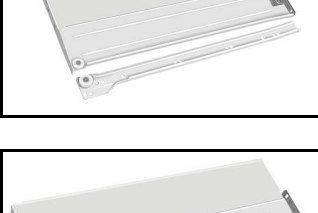
4750943147213	GT-350	Tandem vadotne nepilna izvilkuma 350 mm	2,822	
4750943147220	GT-400	Tandem vadotne nepilna izvilkuma 400 mm	3,220	
4750943147237	GT-450	Tandem vadotne nepilna izvilkuma 450 mm	3,517	
2770040033082	MV-250	Met.vadula 45.7*12.7*250/500	1,258	
2770040025735	MV-300	Met.vadula 45.7*12.7*300/600	1,523	
2770040025759	MV-350	Met.vadula 45.7*12.7*350/700	1,730	
2770040033090	MV-400	Met.vadula 45.7*12.7*400/800	1,995	
2770040025728	MV-450	Met.vadula 45.7*12.7*450/900	2,252	
2770040025766	MV-500	Met.vadula 45.7*12.7*500/1000 (~38kg)	2,410	
2770040025896	MV-550	Met.vadula 45.7*12.7*550/1100	2,678	
2770040033105	MV-600	Met.vadula 45.7*12.7*600/1200	2,990	
2770040033112	MV-650	Met.vadula 45.7*12.7*650/1300	3,203	
2770040025902	MV-700	Met.vadula 45.7*12.7*700/1400	3,413	
2770040024127	BA-250	Vadula pašaizv.250 balta	0,366	
2770040024134	BR-250	Vadula pašaizv.250 brūna	0,366	
2770040024141	BA-300	Vadula pašaizv.300 balta	0,412	
2770040024165	BR-300	Vadula pašaizv.300 brūna	0,412	
2770040024172	BA-350	Vadula pašaizv.350 balta	0,458	
2770040024196	BR-350	Vadula pašaizv.350 brūna	0,458	
2770040024202	BA-400	Vadula pašaizv.400 balta	0,504	
2770040033129	BR-400	Vadula pašaizv.400 brūna	0,504	
2770040024233	BA-450	Vadula pašaizv.450 balta	0,561	

2770040024257	BR-450	Vadula pašaizv.450 brūna	0,561	
2770040024264	BA-500	Vadula pašaizv.500 balta	0,607	
2770040033136	BR-500	Vadula pašaizv.500 brūna	0,607	
2770040033143	BA-550	Vadula pašaizv.550 balta	0,687	
2770040033150	BR-550	Vadula pašaizv.550 brūna	0,687	
2770040024295	BA-600	Vadula pašaizv.600 balta	0,710	
2770040024301	BR-600	Vadula pašaizv.600 brūna	0,710	
2770040025773	SK-182	Lodīšu vadotne L-182	0,251	
2770040025704	SK-214	Lodīšu vadotne L-214	0,286	
2770040025780	SK-246	Lodīšu vadotne L-246	0,320	
2770040025797	SK-278	Lodīšu vadotne L-278	0,355	
2770040025742	SK-310	Lodīšu vadotne L-310	0,388	
2770040025803	SK-342	Lodīšu vadotne L-342	0,434	
4750943147268	M400-1	Reliņš metaboksiem L-400 (2gab.), balts	1,275	
4750943147299	M400-9	Reliņš metaboksiem L-400 (2gab.), pelēks	1,275	
4750943147275	M450-1	Reliņš metaboksiem L-450 (2gab.), balts	1,349	
4750943147305	M450-9	Reliņš metaboksiem L-450 (2gab.), pelēks	1,349	
4750943147282	M500-1	Reliņš metaboksiem L-500 (2gab.), balts	1,529	
4750943147312	M500-9	Reliņš metaboksiem L-500 (2gab.), pelēks	1,529	
2770040033167	M86-270	Metaboks 86/270 mm, balts	1,390	
2770040033174	M86-300	Metaboks 86/300 mm, balts	1,507	
2770040033181	M86-350	Metaboks 86/350 mm, balts	1,635	
2770040024318	M86-400	Metaboks 86/400 mm, balts	1,751	
2770040024325	M86-450	Metaboks 86/450 mm, balts	1,891	
2770040024332	M86-500	Metaboks 86/500 mm, balts	2,007	
2770040033198	M86-550	Metaboks 86/550 mm, balts	2,102	
4750943007548	M86-350-P	Metaboks 86/350 mm, pelēks	1,833	
4750943007555	M86-400-P	Metaboks 86/400 mm, pelēks	2,007	
4750943007562	M86-450-P	Metaboks 86/450 mm, pelēks	2,171	
4750943007579	M86-500-P	Metaboks 86/500 mm, pelēks	2,334	
2770040033204	M118-350	Metaboks 118/350 mm, balts	1,833	
2770040024349	M118-400	Metaboks 118/400 mm, balts	1,973	
2770040024356	M118-450	Metaboks 118/450 mm, balts	2,125	
2770040033211	M118-500	Metaboks 118/500 mm, balts	2,324	
2770040033228	M150-270	Metaboks 150/270 mm, balts	1,728	
2770040033235	M150-300	Metaboks 150/300 mm, balts	1,857	
2770040033242	M150-350	Metaboks 150/350 mm, balts	2,007	
2770040033259	M150-400	Metaboks 150/400 mm, balts	2,148	
2770040008004	M150-450	Metaboks 150/450 mm, balts	2,358	
2770040008011	M150-500	Metaboks 150/500 mm, balts	2,451	
2770040033266	M150-550	Metaboks 150/550 mm, balts	2,568	
4750943007586	M150-350-P	Metaboks 150/350 mm, pelēks	2,288	
4750943007630	M150-400-P	Metaboks 150/400 mm, pelēks	2,487	
4750943007647	M150-450-P	Metaboks 150/450 mm, pelēks	2,697	
4750943007654	M150-500-P	Metaboks 150/500 mm, pelēks	2,861	

Klaviatūras plaukts izvelkams

2770040033273	K-500	Klaviatūras turētājs, pelēks	3,200	
2770040020723	K-501	Klaviatūras turētājs, melns	3,200	
2770040020501	K-600	Klaviatūras turētājs ar peles turētāju, pelēks		
2770040033280	K-601	Klaviatūras turētājs ar peles turētāju, melns		

Plauktu turētāji

4750943006114	G-528-L4	Plaukta turētājs 73x105 hromēts, (2 gab.)	3,695	
4750943006121	G-528-L6	Plaukta turētājs 73x105 niķelēts mat., (2 gab.)	3,695	
4750943006138	G-528-L8	Plaukta turētājs 73x105 hromēts mat., (2 gab.)	3,695	
4750943006145	G-528-L7	Plaukta turētājs 73x105 slīpēts inox, (2 gab.)	3,695	
4750943006152	G-528-M4	Plaukta turētājs 54x75 hromēts, (2 gab.)	1,958	
4750943006169	G-528-M6	Plaukta turētājs 54x75 niķelēts mat., (2 gab.)	1,958	
4750943006176	G-528-M8	Plaukta turētājs 54x75 hromēts mat., (2 gab.)	1,958	
4750943006183	G-528-M7	Plaukta turētājs 54x75 slīpēts inox, (2 gab.)	1,958	
4750943006190	G-528-S4	Plaukta turētājs 46x55 hromēts, (2 gab.)	1,517	
4750943006206	G-528-S6	Plaukta turētājs 46x55 niķelēts mat., (2 gab.)	1,517	
4750943006213	G-528-S8	Plaukta turētājs 46x55 hromēts mat., (2 gab.)	1,517	
4750943006220	G-528-S7	Plaukta turētājs 46x55 slīpēts inox, (2 gab.)	1,517	

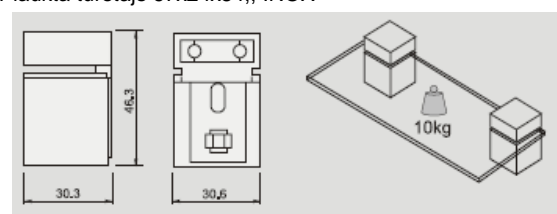
4750943147350	GS02-4	Plaukta turētājs 67x24x84, hromēts	1,593	
4750943147367	GS02-8	Plaukta turētājs 67x24x84,, matēts hroms	1,653	
4750943147374	GS02-7	Plaukta turētājs 67x24x84,, INOX	1,729	
				

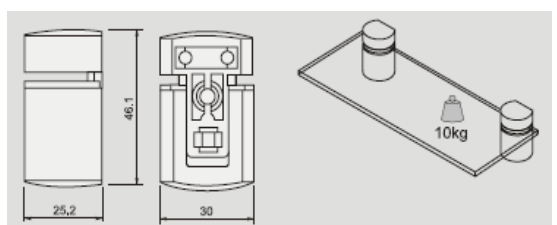
4750943147329	GS01-4	Plaukta turētājs 30x30x46, hromēts	1,407	
4750943147336	GS01-8	Plaukta turētājs 30x30x46, matēts hroms	1,492	
4750943147343	GS01-7	Plaukta turētājs 30x30x46, INOX	1,534	
				

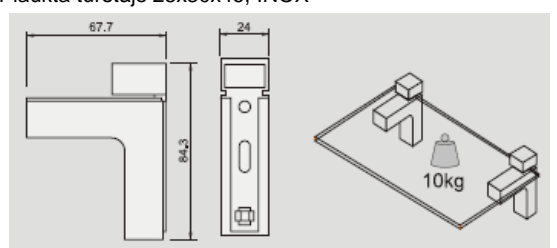
4750943147381	GS04-4	Plaukta turētājs 25x30x46, hromēts	2,356	
4750943147398	GS04-8	Plaukta turētājs 25x30x46, matēts hroms	2,458	
4750943147404	GS04-7	Plaukta turētājs 25x30x46, INOX	2,551	
				

4750943006237	WP2710-2	Plauktu turētētājs 21x47, hromēts	0,390	
4750943006244	WP2710-5	Plauktu turētētājs 21x47, niķelēts mat.	0,390	
4750943006251	WP2710-8	Plauktu turētētājs 21x47, inox	0,390	
4750943006268	WP2710-6	Plauktu turētētājs 21x47, hromēts mat.	0,390	
4750943006275	WP2710-3	Plauktu turētētājs 21x47, zeltīts	0,390	

4750943006282	WP2713-2	Plauktu turētētājs 21x54, hromēts	0,593	
4750943006299	WP2713-5	Plauktu turētētājs 21x54, niķelēts mat.	0,593	
4750943006305	WP2713-8	Plauktu turētētājs 21x54, inox	0,593	
4750943006312	WP2713-6	Plauktu turētētājs 21x54, hromēts mat.	0,593	
4750943006329	WP2713-3	Plauktu turētētājs 21x54, zeltīts	0,593	

4750943006336	12-1	Konsole ar dekoratīvo uzliku 12cm, 2gab. Hromēta	0,668	
4750943006343	12-2	Konsole ar dekoratīvo uzliku 12cm, 2gab. Balta	0,517	
4750943006350	12-3	Konsole ar dekoratīvo uzliku 12cm, 2gab. Melna	0,517	
4750943006367	12-4	Konsole ar dekoratīvo uzliku 12cm, 2gab. Brūna	0,517	
4750943006404	12-5	Konsole ar dekoratīvo uzliku 12cm, 2gab. T-brūna	0,517	
4750943006381	12-6	Konsole ar dekoratīvo uzliku 12cm, 2gab. Bēša	0,517	
4750943006398	12-7	Konsole ar dekoratīvo uzliku 12cm, 2gab. Pelēka	0,517	
4750943006428	18-1	Konsole ar dekoratīvo uzliku 18cm, 2gab. Hromēta	1,024	
4750943006435	18-2	Konsole ar dekoratīvo uzliku 18cm, 2gab. Balta	0,810	
4750943006442	18-3	Konsole ar dekoratīvo uzliku 18cm, 2gab. Melna	0,810	
4750943006459	18-4	Konsole ar dekoratīvo uzliku 18cm, 2gab. Brūna	0,810	
4750943006466	18-5	Konsole ar dekoratīvo uzliku 18cm, 2gab. T-brūna	0,810	
4750943006473	18-6	Konsole ar dekoratīvo uzliku 18cm, 2gab. Bēša	0,810	
4750943006480	18-7	Konsole ar dekoratīvo uzliku 18cm, 2gab. Pelēka	0,810	
4750943006497	24-1	Konsole ar dekoratīvo uzliku 24cm, 2gab. Hromēta	1,263	
4750943006503	24-2	Konsole ar dekoratīvo uzliku 24cm, 2gab. Balta	1,042	
4750943006510	24-3	Konsole ar dekoratīvo uzliku 24cm, 2gab. Melna	1,042	
4750943006527	24-4	Konsole ar dekoratīvo uzliku 24cm, 2gab. Brūna	1,042	
4750943006534	24-5	Konsole ar dekoratīvo uzliku 24cm, 2gab. T-brūna	1,042	
4750943006541	24-6	Konsole ar dekoratīvo uzliku 24cm, 2gab. Bēša	1,042	
4750943006558	24-7	Konsole ar dekoratīvo uzliku 24cm, 2gab. Pelēka	1,042	

Galda kājas

2770040034294	507102	Galda kāja Ø 50x710 hromēta	2,973	
2770040034317	507109	Galda kāja Ø 50x710 pelēka krāsota	2,895	
2770040034300	507104	Galda kāja Ø 50x710 melna krāsota	2,702	
2770040034324	507106	Galda kāja Ø 50x710 matēts hroms	3,322	
2770040034331	507105	Galda kāja Ø 50x710 matēts niķelis	3,322	
4750943006565	507108	Galda kāja Ø 50x710 inox	2,924	
4750943012511	607101	Galda kāja Ø60x710 balta krāsota	3,307	
2770040020167	607102	Galda kāja Ø 60x710 hromēta	2,457	
4750943012481	607103	Galda kāja Ø 60x710 zeltīta	4,043	
2770040020181	607104	Galda kāja Ø 60x710 melna krāsota	2,315	
2770040033303	607105	Galda kāja Ø 60x710 matēts niķelis	3,208	
2770040029665	607106	Galda kāja Ø 60x710 matēts hroms	3,208	
2770040020198	607108	Galda kāja Ø 60x710 inox	2,899	
2770040020204	607109	Galda kāja Ø 60x710 pelēka krāsota	2,447	
2770040020211	608202	Galda kāja Ø 60x820 hromēta	3,308	
4750943012498	608203	Galda kāja Ø 60x820 zeltīta	5,3814	
2770040033310	608204	Galda kāja Ø 60x820 melna matēta	4,220	
2770040033327	608205	Galda kāja Ø 60x820 matēts niķelis	4,459	
2770040030777	608206	Galda kāja Ø 60x820 matēts hroms	5,500	
2770040020242	608208	Galda kāja Ø 60x820 inox	3,780	
2770040020259	601102	Galda kāja Ø 60x1100 hromēta	4,178	
2770040033334	601104	Galda kāja Ø 60x1100 melna matēta	4,359	
2770040033341	601105	Galda kāja Ø 60x1100 matēts niķelis	5,850	
2770040033358	601106	Galda kāja Ø 60x1100 matēts hroms	7,000	
4750943012504	601103	Galda kāja Ø 60x1100 zeltīta 6.18	11,258	
2770040020273	601108	Galda kāja Ø 60x1100 inox	4,497	
4750943006572	601109	Galda kāja Ø 60x1100 pelēka krāsota	4,620	
4750943012528	60710-A	Galda kāja Ø60x710 AL rievota	6,129	
4750943012535	60710-Z	Galda kāja Ø60x710 zelt./AL rievota	6,211	
4750943012542	60710-B	Galda kāja Ø60x710 antīka/AL rievota	6,211	
4750943012603	60820-A	Galda kāja Ø60x820 AL rievota	7,336	
4750943012610	60820-Z	Galda kāja Ø60x820 zelt./AL rievota	7,475	
4750943012627	60820-B	Galda kāja Ø60x820 antīka/AL rievota	7,475	

4750943012559	427102	Galda kāja Ø42x710 hromēta koniska	9,225	
4750943012566	427104	Galda kāja Ø42x710 melna koniska	8,871	
4750943012573	427108	Galda kāja Ø42x710 inox koniska	9,225	
4750943012580	60-307104	Galda kāja Ø60/30x710 melna koniska	9,724	
2770040035062	60-307108	Galda kāja Ø60/30x710 inox koniska	9,724	

4750943012597	60710-K	Galda kāja Ø60x710 ar ķirškoka vidu alumīnija	16,900	
---------------	---------	---	---------------	---

	60-60710-K	Galda kāja 60x60x710 ar ķirškoka vidu alumīnija	19,068	
--	------------	---	---------------	--















	60710-R	Galda kāja Ø60x710 ar ritenīti un bremzi MCR	19,280	
--	---------	--	---------------	---













	60-710-ALU	Galda kāja 60x60x710 alumīnija	9,805	
--	------------	--------------------------------	--------------	---









Mēbeļu rokturi

2770040033365	WP01-96-6	Rokturis cc96mm, matēts niķelis	0,399	
2770040033372	WP01-96-4	Rokturis cc96mm, hroms	0,399	
2770040033389	WP01-96-8	Rokturis cc96mm, matēts hroms	0,399	
2770040033396	WP01-96-3	Rokturis cc96mm, zeltīts	0,399	

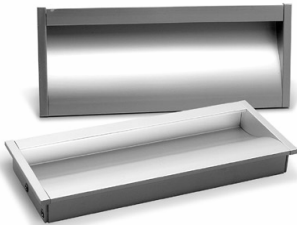
2770040022444	WP01-128-6	Rokturis cc128mm, matēts niķelis	0,441	
2770040033402	WP01-128-4	Rokturis cc128mm, hroms	0,441	
2770040033419	WP01-128-8	Rokturis cc128mm, matēts hroms	0,441	
2770040033426	WP01-128-3	Rokturis cc128mm, zeltīts	0,441	

2770040022406	WP02-128-6	Rokturis cc128mm, L145, h29, a10 matēts niķelis	0,423	
2770040033433	WP02-128-4	Rokturis cc128mm, L145, h29, a10 hroms	0,423	
2770040033440	WP02-128-8	Rokturis cc128mm, L145, h29, a10 matēts hroms	0,423	
2770040033457	WP02-128-3	Rokturis cc128mm, L145, h29, a10 zeltīts	0,423	
4750943006589	WP02-128-2	Rokturis cc128mm, L145, h29, a10 melns mat.	0,423	
2770040033464	WP03-96-6	Rokturis cc96mm, matēts niķelis	0,294	
2770040033471	WP03-96-4	Rokturis cc96mm, hroms	0,294	
2770040033488	WP03-96-8	Rokturis cc96mm, matēts hroms	0,294	
2770040033495	WP03-96-3	Rokturis cc96mm, zeltīts	0,294	
2770040025032	WP04-96-6	Rokturis cc96mm, matēts niķelis	0,412	
2770040025018	WP04-96-4	Rokturis cc96mm, hroms	0,412	
2770040033501	WP04-96-8	Rokturis cc96mm, matēts hroms	0,412	
2770040025025	WP04-96-3	Rokturis cc96mm, zeltīts	0,412	
2770040033518	WP04-128-6	Rokturis cc128mm, matēts niķelis	0,498	
2770040033525	WP04-128-4	Rokturis cc128mm, hroms	0,498	
2770040033532	WP04-128-8	Rokturis cc128mm, matēts hroms	0,498	
2770040033549	WP04-128-3	Rokturis cc128mm, zeltīts	0,498	
2770040033556	WP05-96-6	Rokturis cc96mm, matēts niķelis	0,405	
2770040033563	WP05-96-4	Rokturis cc96mm, hroms	0,405	
2770040033570	WP05-96-8	Rokturis cc96mm, matēts hroms	0,405	
2770040033587	WP05-96-3	Rokturis cc96mm, zeltīts	0,405	
2770040033594	WP05-128-6	Rokturis cc128mm, matēts niķelis	0,449	
2770040025995	WP05-128-4	Rokturis cc128mm, hroms	0,449	
2770040027401	WP05-128-8	Rokturis cc128mm, matēts hroms	0,449	
2770040033600	WP05-128-3	Rokturis cc128mm, zeltīts	0,449	
2770040033617	WP06-128-6	Rokturis cc128mm, matēts niķelis	0,348	
2770040026053	WP06-128-4	Rokturis cc128mm, hroms	0,348	
2770040021942	WP06-128-8	Rokturis cc128mm, matēts hroms	0,348	
2770040023267	WP06-128-3	Rokturis cc128mm, zeltīts	0,348	
2770040033624	WP07-96-6	Rokturis cc96mm, matēts niķelis	0,270	
2770040026084	WP07-96-4	Rokturis cc96mm, hroms	0,270	
2770040021911	WP07-96-8	Rokturis cc96mm, matēts hroms	0,270	
2770040028309	WP07-96-3	Rokturis cc96mm, zeltīts	0,270	
2770040032511	WP14-96-7	Rokturis cc96mm, slīpēts inox	0,449	
2770040033631	WP14-96-4	Rokturis cc96mm, hroms	0,449	
2770040033648	WP14-96-8	Rokturis cc96mm, matēts hroms	0,449	
2770040033655	WP14-96-3	Rokturis cc96mm, zeltīts	0,449	
2770040032528	WP14-128-7	Rokturis cc128mm, slīpēts inox	0,530	
2770040033662	WP14-128-3	Rokturis cc128mm, zeltīts	0,530	
2770040033679	WP14-128-4	Rokturis cc128mm, hroms	0,530	
2770040022178	WP14-128-8	Rokturis cc128mm, matēts hroms	0,530	
2770040026015	WP15-64-4	Rokturis cc64mm, hroms	0,450	
2770040026039	WP15-96-4	Rokturis cc96mm, hroms	0,520	
2770040033723	WP17-96-6	Rokturis cc96mm, matēts niķelis	0,370	
2770040032535	WP17-96-7	Rokturis cc96mm, slīpēts inox	0,370	
2770040033730	WP17-128-6	Rokturis cc128mm, matēts niķelis	0,450	
2770040032542	WP17-128-7	Rokturis cc128mm, slīpēts inox	0,450	
2770040033747	WP17-128-3	Rokturis cc128mm, zeltīts	0,450	

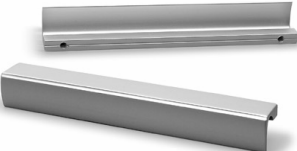
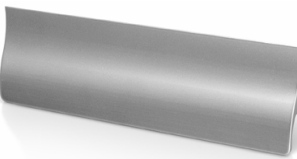
2770040032559	WP18-128-7	Rokturis cc128mm, slīpēts inox	0,624	
2770040033754	WP18-128-3	Rokturis cc128mm, zeltīts	0,624	
2770040026114	WP18-128-8	Rokturis cc128mm, matēts hroms	0,624	
2770040032580	WP13-96-33	Rokturis cc96mm, vecs zelts	0,387	
2770040033815	WP13-96-6	Rokturis cc96mm, matēts niķelis	0,387	
4750943006596	WP13-96-4	Rokturis cc96mm, hromēts	0,387	
4750943006602	WP13-96-8	Rokturis cc96mm, matēts hroms	0,387	
2770040033839	WP11-36	Rokturis antīks	0,378	
2770040033846	WP11-46	Rokturis antīks	0,378	
2770040033853	WP11-47	Rokturis antīks	0,259	
2770040033877	WP10-96	Rokturis cc96mm, antīks	0,399	
2770040033884	WP12-41	Rokturis antīks	0,350	
2770040032603	0728J	Rokturis poga, antīks ar porcelāna ielikni	0,490	
2770040032610	0728i	Rokturis poga porcelāna	0,320	
2770040032627	0728P	Rokturis cc96mm, antīks ar porcelāna ielikni	0,882	
2770040032634	0728B	Rokturis cc96mm, antīks ar porcelāna ielikni	0,825	
2770040033891	ZH008-4	Rokturis cc128mm, hromēts	0,462	
2770040033907	ZH008-6	Rokturis cc128mm, matēts niķelis	0,462	

2770040033914	ZH010-96-4	Rokturis cc96mm, hromēts	0,455	
2770040033921	ZH010-96-6	Rokturis cc96mm, matēts niķelis	0,455	
4750943006626	ZH010-96-8	Rokturis cc96mm, matēts hroms	0,455	
4750943006633	ZH010-96-3	Rokturis cc96mm, zeltīts	0,455	
2770040023748	ZH010-128-4	Rokturis cc128mm, hromēts	0,557	
2770040033938	ZH010-128-6	Rokturis cc128mm, matēts niķelis	0,557	
4750943006640	ZH010-128-8	Rokturis cc128mm, matēts hroms	0,557	
4750943006657	ZH010-128-3	Rokturis cc128mm, zeltīts	0,557	
4750943006664	WPY315-96	Rokturis cc96mm, alumīnija	1,339	
4750943006671	WPY315-128	Rokturis cc128mm, alumīnija	1,483	
4750943006688	WPY315-160	Rokturis cc160mm, alumīnija	1,585	
4750943006695	WPY315-192	Rokturis cc192mm, alumīnija	1,703	
4750943006701	WPY315-224	Rokturis cc224mm, alumīnija	1,856	
4750943006718	WPY315-256	Rokturis cc256mm, alumīnija	2,059	
4750943006725	WPY315-320	Rokturis cc320mm, alumīnija	2,254	
4750943006732	WPY316-64	Rokturis cc64mm, alumīnija	0,992	
4750943006749	WPY316-96	Rokturis cc96mm, alumīnija	1,203	
4750943006756	WPY316-128	Rokturis cc128mm, alumīnija	1,339	
4750943006763	WPY316-160	Rokturis cc160mm, alumīnija	1,568	
4750943006770	WPY316-192	Rokturis cc192mm, alumīnija	1,822	
4750943006787	WPY319-96	Rokturis cc96mm, alumīnija	0,907	
4750943006794	WPY319-128	Rokturis cc128mm, alumīnija	1,025	
4750943006800	WPY319-160	Rokturis cc160mm, alumīnija	1,169	
4750943006817	WPY322-96	Rokturis cc96mm, alumīnija	0,797	
4750943006824	WPY322-128	Rokturis cc128mm, alumīnija	0,873	
4750943006831	WPY322-160	Rokturis cc160mm, alumīnija	1,017	
4750943006848	WPY322-192	Rokturis cc192mm, alumīnija	1,186	
4750943006855	WPY322-224	Rokturis cc224mm, alumīnija	1,381	
4750943006862	WPY322-256	Rokturis cc256mm, alumīnija	1,576	
4750943006879	WPY322-320	Rokturis cc320mm, alumīnija	1,763	
4750943006886	WPY326-64	Rokturis cc64mm, alumīnija	0,979	
4750943006893	WPY326-96	Rokturis cc96mm, alumīnija	1,094	
4750943006909	WPY326-128	Rokturis cc128mm, alumīnija	1,175	
4750943006916	WPY326-160	Rokturis cc160mm, alumīnija	1,273	
4750943006923	WPY333-32	Rokturis cc32mm, alumīnija	0,466	
4750943006930	WPY333-64	Rokturis cc64mm, alumīnija	0,551	
4750943007494	WPY333-96	Rokturis cc96mm, alumīnija	0,627	
4750943006947	WPY333-128	Rokturis cc128mm, alumīnija	0,720	
4750943006954	WPY333-160	Rokturis cc160mm, alumīnija	0,771	
4750943006961	WPY333-192	Rokturis cc192mm, alumīnija	0,864	
4750943006978	WPY333-224	Rokturis cc224mm, alumīnija	0,966	
4750943006985	WPY341-64	Rokturis cc64mm, alumīnija	0,952	
4750943006992	WPY341-96	Rokturis cc96mm, alumīnija	1,032	
4750943007005	WPY341-128	Rokturis cc128mm, alumīnija	1,175	
4750943007012	WPY341-160	Rokturis cc160mm, alumīnija	1,388	
4750943007029	WPY341-192	Rokturis cc192mm, alumīnija	1,664	
4750943007036	WPY341-224	Rokturis cc224mm, alumīnija	1,985	
4750943007043	WPY341-256	Rokturis cc256mm, alumīnija	2,261	
4750943007050	WPY341-320	Rokturis cc320mm, alumīnija	2,545	
4750943007067	WPY356-90	Rokturis cc90mm, alumīnija	1,211	
4750943007074	WPY356-120	Rokturis cc120mm, alumīnija	1,335	
4750943007081	WPY356-150	Rokturis cc150mm, alumīnija	1,495	
4750943007098	WPY356-128	Rokturis cc128mm, alumīnija	1,042	
4750943007104	WPY356-160	Rokturis cc160mm, alumīnija	1,211	

2770040032641	WPY380-128	Rokturis cc128mm, alumīnija	1,257	
2770040032658	WPY380-160	Rokturis cc160mm, alumīnija	1,430	
2770040032665	WPY380-192	Rokturis cc192mm, alumīnija	1,658	
2770040032672	WPY380-224	Rokturis cc224mm, alumīnija	1,842	
2770040032689	WPY380-256	Rokturis cc256mm, alumīnija	2,037	
2770040032696	WPY380-320	Rokturis cc320mm, alumīnija	2,449	

2770040032702	WPY385-96	Rokturis cc96mm, alumīnija	0,693	
2770040032719	WPY385-128	Rokturis cc128mm, alumīnija	0,809	
2770040032726	WPY385-160	Rokturis cc160mm, alumīnija	0,914	
2770040032733	WPY385-192	Rokturis cc192mm, alumīnija	1,040	
2770040032740	WPY385-224	Rokturis cc224mm, alumīnija	1,155	
2770040032757	WPY385-256	Rokturis cc256mm, alumīnija	1,260	
2770040032764	WPY385-320	Rokturis cc320mm, alumīnija	1,491	

2770040032771	WPY387-96	Rokturis cc96mm, alumīnija	0,578	
2770040032788	WPY387-128	Rokturis cc128mm, alumīnija	0,641	
2770040032795	WPY387-160	Rokturis cc160mm, alumīnija	0,777	
2770040032801	WPY387-192	Rokturis cc192mm, alumīnija	0,893	
2770040032818	WPY387-224	Rokturis cc224mm, alumīnija	1,029	
2770040032825	WPY387-256	Rokturis cc256mm, alumīnija	1,145	
2770040032832	WPY387-288	Rokturis cc288mm, alumīnija	1,271	
2770040032849	WPY387-320	Rokturis cc320mm, alumīnija	1,407	

2770040032856	WPY313-96	Rokturis cc96mm, alumīnija	0,918	
2770040032863	WPY313-128	Rokturis cc128mm, alumīnija	0,996	
2770040032870	WPY313-160	Rokturis cc160mm, alumīnija	1,117	
2770040032887	WPY313-192	Rokturis cc192mm, alumīnija	1,250	
2770040032894	WPY313-224	Rokturis cc224mm, alumīnija	1,372	
2770040032900	WPY313-256	Rokturis cc256mm, alumīnija	1,494	
2770040032917	WPY313-320	Rokturis cc320mm, alumīnija	1,759	

2770040032924	WPY338-96	Rokturis cc96mm, alumīnija	0,885	
2770040032931	WPY338-128	Rokturis cc128mm, alumīnija	1,007	
2770040032948	WPY338-160	Rokturis cc160mm, alumīnija	1,129	

2770040032955	WPY337-96	Rokturis cc96mm, alumīnija	0,786	
2770040032962	WPY337-128	Rokturis cc128mm, alumīnija	0,908	
2770040032979	WPY337-160	Rokturis cc160mm, alumīnija	1,029	
2770040032986	WPY337-192	Rokturis cc192mm, alumīnija	1,129	
2770040032993	WPY337-224	Rokturis cc224mm, alumīnija	1,250	
2770040033006	WPY337-256	Rokturis cc256mm, alumīnija	1,361	
2770040033013	WPY337-320	Rokturis cc320mm, alumīnija	1,604	

4750943007111	AA04-96	Rokturis cc96mm, alumīnija	0,979	
4750943007128	AA04-128	Rokturis cc128mm, alumīnija	1,094	
4750943007135	AA04-160	Rokturis cc160mm, alumīnija	1,211	
4750943007142	AA04-192	Rokturis cc192mm, alumīnija	1,335	
4750943007159	AA04-224	Rokturis cc224mm, alumīnija	1,450	
4750943007166	AA04-256	Rokturis cc256mm, alumīnija	1,557	
4750943007173	AA04-288	Rokturis cc288mm, alumīnija	1,673	

4750943147480	WP-34	Rokturis, antiķis	0,754	
4750943147497	WP-43	Rokturis, antiķis	0,941	

4750943147503	SKN-128	Rokturis cc128mm, nerūsējošā tērauda	2,237	
4750943147510	SKN-160	Rokturis cc160mm, nerūsējošā tērauda	2,398	
4750943147527	SKN-192	Rokturis cc192mm, nerūsējošā tērauda	2,542	
4750943147541	SKN-224	Rokturis cc224mm, nerūsējošā tērauda	2,678	
4750943147558	SKN-320	Rokturis cc320mm, nerūsējošā tērauda	3,127	
4750943147565	SKN-384	Rokturis cc384mm, nerūsējošā tērauda	3,542	
4750943147572	SKN-448	Rokturis cc448mm, nerūsējošā tērauda	3,746	
4750943147589	SKN-480	Rokturis cc480mm, nerūsējošā tērauda	4,559	

4750943147596	UZ-224-4	Rokturis iefrēzējams D-40, H-12, hromēts	0,729	
4750943147602	UZ-224-8	Rokturis iefrēzējams D-40, H-12, matēts hroms	0,797	
4750943147619	UZ-224-6	Rokturis iefrēzējams D-40, H-12, matēts niķelis	0,797	



4750943147626	UZ-226-4	Rokturis iefrēzējams 40x40, hromēts	0,729	
4750943147633	UZ-226-8	Rokturis iefrēzējams 40x40, matēts hroms	0,797	
4750943147640	UZ-226-6	Rokturis iefrēzējams 40x40, matēts niķelis	0,797	

4750943147657	UZ334-128	Rokturis cc128mm, INOX	1,542	
4750943147657	UZ334-160	Rokturis cc160mm, INOX	1,661	
4750943147671	UZ334-192	Rokturis cc192mm, INOX	1,737	
4750943147688	UZ334-256	Rokturis cc256mm, INOX	1,907	

4750943147695	UZ336-128	Rokturis cc128mm, INOX	1,729											
4750943147701	UZ336-160	Rokturis cc160mm, INOX	1,814											
4750943147718	UZ336-192	Rokturis cc192mm, INOX	1,873											
4750943147725	UZ336-256	Rokturis cc256mm, INOX	2,034											
		<table border="1"> <tr> <td>L</td> <td>128</td> <td>160</td> <td>192</td> <td>256</td> </tr> <tr> <td>Lc</td> <td>136</td> <td>170</td> <td>209</td> <td>268</td> </tr> </table>	L		128	160	192	256	Lc	136	170	209	268	
L	128	160	192	256										
Lc	136	170	209	268										

4750943147732	UZ682-128	Rokturis cc128mm, INOX	1,542	
4750943147749	UZ682-160	Rokturis cc160mm, INOX	1,602	
4750943147756	UZ682-192	Rokturis cc192mm, INOX	1,678	
4750943147763	UZ682-256	Rokturis cc256mm, INOX	1,856	

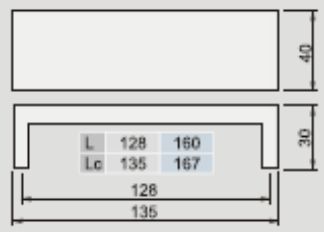
4750943147770	UZ40-4	Rokturis cc32mm, hromēts	0,992	
4750943147787	UZ40-8	Rokturis cc32mm, matēts hroms	1,051	
4750943147794	UZ40-7	Rokturis cc32mm, INOX	1,102	

4750943147800	UZ92-4	Rokturis cc128mm, hromēts	2,254	
4750943147824	UZ92-8	Rokturis cc128mm, matēts hroms	2,339	
4750943147831	UZ92-7	Rokturis cc128mm, INOX	2,517	
				
4750943147848	UZ71-96-4	Rokturis cc96mm, hromēts	0,754	
4750943147855	UZ71-96-6	Rokturis cc96mm, matēts niķelis	0,831	
4750943147862	UZ71-128-4	Rokturis cc128mm, hromēts	1,076	
4750943147879	UZ71-128-6	Rokturis cc128mm, matēts niķelis	1,161	
2770040033020	WP1153-7	Rokturis poga slīpēts inox	0,378	
2770040033952	WP1153-4	Rokturis poga hromēts	0,378	
2770040033969	WP1153-8	Rokturis poga matēts hroms	0,378	
2770040033945	WP1153-6	Rokturis poga matēts niķelis	0,378	
2770040034003	WP1155-8	Rokturis poga matēts hroms	0,284	
2770040034010	WP1155-6	Rokturis poga matēts niķelis	0,284	
2770040034027	WP1155-4	Rokturis poga hromēts	0,284	
2770040034041	ZH011	Rokturis poga hroms	0,284	







Reliņa rokturi

2770040019659	851561	Reliņa rokturis, L - 96/156, hromēts	0,683	
2770040019666	851562	Reliņa rokturis, L - 96/156, matēts hroms	0,683	
2770040019673	851563	Reliņa rokturis, L - 96/156, matēts niķelis	0,683	
2770040019680	851281	Reliņa rokturis, L - 128/188, hromēts	0,735	
2770040019697	851282	Reliņa rokturis, L - 128/188, matēts hroms	0,735	
2770040019703	851283	Reliņa rokturis, L - 128/188, matēts niķelis	0,735	
2770040019710	851601	Reliņa rokturis, L - 160/220, hromēts	0,798	
2770040019727	851602	Reliņa rokturis, L - 160/220, matēts hroms	0,798	
2770040019734	851603	Reliņa rokturis, L - 160/220, matēts niķelis	0,798	
2770040034058	851921	Reliņa rokturis, L - 192/272, hromēts	0,872	
2770040034065	851922	Reliņa rokturis, L - 192/272, matēts hroms	0,872	
2770040034072	851923	Reliņa rokturis, L - 192/272, matēts niķelis	0,872	
2770040019741	852241	Reliņa rokturis, L - 224/304, hromēts	0,956	
2770040019758	852242	Reliņa rokturis, L - 224/304, matēts hroms	0,956	
2770040019765	852243	Reliņa rokturis, L - 224/304, matēts niķelis	0,956	
2770040019772	852881	Reliņa rokturis, L - 288/368, hromēts	1,092	
2770040019789	852882	Reliņa rokturis, L - 288/368, matēts hroms	1,092	
2770040019796	852883	Reliņa rokturis, L - 288/368, matēts niķelis	1,092	
2770040019802	853201	Reliņa rokturis, L - 320/400, hromēts	1,176	
2770040019819	853202	Reliņa rokturis, L - 320/400, matēts hroms	1,176	
2770040019826	853203	Reliņa rokturis, L - 320/400, matēts niķelis	1,176	
2770040019833	853841	Reliņa rokturis, L - 384/464, hromēts	1,302	
2770040019840	853842	Reliņa rokturis, L - 384/464, matēts hroms	1,302	
2770040019857	853843	Reliņa rokturis, L - 384/464, matēts niķelis	1,302	
2770040034089	854481	Reliņa rokturis, L - 448/528, hromēts	1,481	
2770040034096	854482	Reliņa rokturis, L - 448/528, matēts hroms	1,481	
2770040034102	854483	Reliņa rokturis, L - 448/528, matēts niķelis	1,481	
2770040019864	854801	Reliņa rokturis, L - 480/560, hromēts	1,554	
2770040019871	854802	Reliņa rokturis, L - 480/560, matēts hroms	1,554	
2770040019888	854803	Reliņa rokturis, L - 480/560, matēts niķelis	1,554	

Mēbeļu rokturi - dekoratīvie

4750943007180	WP-A	Mēbeļu rokturis, jūras zirdziņš	0,525	
4750943007197	WP-B	Mēbeļu rokturis, bruņurupucis	0,525	
4750943007203	WP-C	Mēbeļu rokturis, zivs mazā	0,525	
4750943007210	WP-D	Mēbeļu rokturis, zivs lielā	0,525	
4750943007227	WP-E	Mēbeļu rokturis, jūras zvaigzne	0,525	
4750943007234	WP-H	Mēbeļu rokturis, gliemežvāks	0,525	
4750943007241	WP-I	Mēbeļu rokturis, krabis	0,525	

Mēbeļu pakarināmie

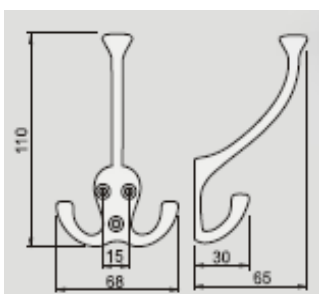
2770040025568	K2404	Pakarināmais 3z dekorat. antīks	0,672	
2770040034119	K2342A-33	Pakarināmais 3z ar punktiem, vecs zelts	0,875	
2770040026633	K2342A-4	Pakarināmais 3z ar punktiem, hroms	0,875	
2770040026657	K2342A-6	Pakarināmais 3z ar punktiem, niķelēts mat.	0,875	
2770040026640	K2342A-3	Pakarināmais 3z ar punktiem, zeltīts	0,875	
4750943007593	K2342A-8	Pakarināmais 3z ar punktiem, hromēts mat.	0,875	
2770040034126	K2342B-33	Pakarināmais 2z ar punktiem, vecs zelts	0,559	
2770040026619	K2342B-4	Pakarināmais 2z ar punktiem, hroms	0,559	
2770040034133	K2342B-6	Pakarināmais 2z ar punktiem, niķelēts mat.	0,559	
2770040026626	K2342B-3	Pakarināmais 2z ar punktiem, zeltīts	0,559	
4750943007609	K2342B-8	Pakarināmais 3z ar punktiem, hromēts mat.	0,559	
2770040025407	K2405A-6	Pakarināmais 3z ar punktiem, niķelēts mat.	0,638	
2770040025384	K2405A-4	Pakarināmais 3z ar punktiem, hroms	0,638	
2770040034140	K2405A-8	Pakarināmais 3z ar punktiem, hromēts mat.	0,638	
2770040025391	K2405A-3	Pakarināmais 3z ar punktiem, zeltīts	0,638	
2770040025414	K2405B-6	Pakarināmais 2z ar punktiem, niķelēts mat.	0,411	
2770040034157	K2405B-4	Pakarināmais 2z ar punktiem, hroms	0,411	
2770040027173	K2405B-8	Pakarināmais 2z ar punktiem, hromēts mat.	0,411	
2770040025360	K2405B-3	Pakarināmais 2z ar punktiem, zeltīts	0,411	
2770040025506	K2405C-6	Pakarināmais 2z ar punktiem, niķelēts mat.	0,294	
2770040025513	K2405C-4	Pakarināmais 2z ar punktiem, hroms	0,294	
2770040034164	K2405C-8	Pakarināmais 2z ar punktiem, hromēts mat.	0,294	
2770040026732	K2405C-3	Pakarināmais 2z ar punktiem, zeltīts	0,294	
4750943147886	K110-4	Pakaramais trīs zari 30x65x110, hromēts	0,992	
4750943147893	K110-6	Pakaramais trīs zari 30x65x110, matēts niķelis	0,992	
4750943147909	K110-8	Pakaramais trīs zari 30x65x110, matēts hroms	0,992	
				

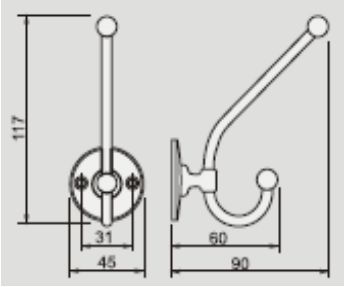
4750943147916	K117-4	Pakaramais divi zari 60x90x117, hromēts	1,314	
4750943147923	K117-7	Pakaramais divi zari 60x90x117, inox	1,314	
4750943147930	K117-8	Pakaramais divi zari 60x90x117, matēts hroms	1,314	
				

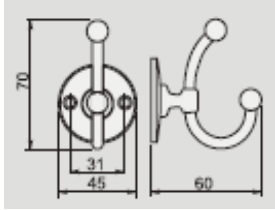
4750943147947	K70-4	Pakaramais divi zari 60x70, hromēts	0,992	
4750943147954	K70-6	Pakaramais divi zari 60x70, matēts niķelis	0,992	
4750943147961	K70-8	Pakaramais divi zari 60x70, matēts hroms	0,992	
				

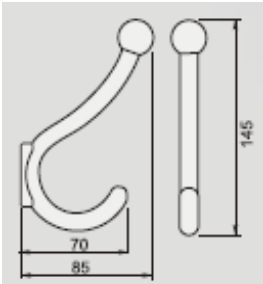
4750943147978	K138-4	Pakaramais divi zari 70x85x145, hromēts	1,966	
4750943147985	K138-6	Pakaramais divi zari 70x85x145, matēts niķelis	1,966	
4750943147992	K138-8	Pakaramais divi zari 70x85x145, matēts hroms	1,966	
				

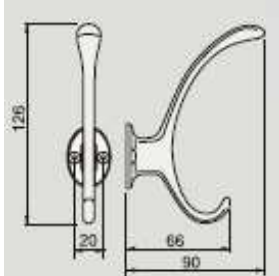
4750943148005	K892-4	Pakaramais divi zari 66x90x126, hromēts	1,263	
4750943148012	K892-6	Pakaramais divi zari 66x90x126, matēts niķelis	1,263	
4750943148029	K892-8	Pakaramais divi zari 66x90x126, matēts hroms	1,263	
				

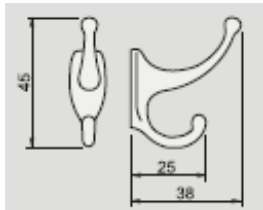
4750943148036	K956-4	Pakaramais divi zari 25x38x45, hromēts	0,551	
4750943148043	K956-6	Pakaramais divi zari 25x38x45, matēts niķelis	0,551	
4750943148050	K956-8	Pakaramais divi zari 25x38x45, matēts hroms	0,551	
				

Virtuves aksesuāri

2770040020082	900081	Glāžu turētājs viena rinda, inox	2,458	
2770040020099	900082	Glāžu turētājs divas rindas, inox	3,625	
2770040026428	900083	Glāžu turētājs trīs rindas, inox	5,766	
2770040020105	900084	Glāžu turētājs četras rindas, inox	4,728	
2770040034379	59028	Dvieļu turētājs izvelkams 3z-590/28, pelēks	4,600	
2770040034386	59040	Dvieļu turētājs izvelkams 3z-590/40, pelēks	4,870	
2770040034393	59045	Dvieļu turētājs izvelkams 3z-590/45, pelēks	4,990	
2770040034409	59048	Dvieļu turētājs izvelkams 3z-590/48, pelēks	5,120	
2770040034416	600.01.450	Dvieļu turētājs izvelkams 2z-L450, gofrēts alumīnijs	6,100	
2770040034423	600.02.450	Dvieļu turētājs izvelkams 2z-L450, matēts hroms	6,000	
	WE11-1	Dvieļu turētājs izvelkams viens zars 65x260x40, hromēts	7,924	
	WE11-2	Dvieļu turētājs izvelkams divi zari 105x260x40, hromēts	9,212	
	WE11-3	Dvieļu turētājs izvelkams trīs zari 155x260x40, hromēts	10,551	
2770040034232	GP.30	Ieliknis galda piederumiem (30), metalizēts	2,112	
2770040034249	GP.40	Ieliknis galda piederumiem (40), metalizēts	2,534	
2770040034256	GP.45	Ieliknis galda piederumiem (45), metalizēts	2,851	
2770040034263	GP.50	Ieliknis galda piederumiem (50), metalizēts	3,168	
2770040034270	GP.60	Ieliknis galda piederumiem (60), metalizēts	3,696	
2770040034287	GP.80	Ieliknis galda piederumiem (80), metalizēts	4,541	
4750943007326	GP.120	Ieliknis galda piederumiem (120), metalizēts	8,976	

Amartizātori - kabelkanāli - magnēti

4750943004714	1015	Amartizātors pašlīmējošs d10x1,5 caurspīdīgs (50gb.)	0,450	
---------------	------	--	--------------	---

4750943004721	1030	Amartizators pašlīmējošs d10x3,0 caurspīdīgs (50gb.)	0,740	
4750943004738	1007	Amartizators pašlīmējošs d7x1,5 caurspīdīgs (50gb.)	0,450	
4750943004776 4750943007487	4001 4200 4-130	Uzkares mehānisms universāls, balts 2gab. Uzkares sliede 2m, cinkota Uzkares sliede 130mm, cinkota	0,420 1,150 0,186	
4750943004844 4750943004851 4750943004868 4750943004882 4750943004899 4750943004905 4750943004912 4750943004929 4750943004936 4750943004943 4750943004950	60-P1 60-P2 60-P4 60-P6 60-P7 80-5 80-0 80-4 80-3 80-2 80-6	Kabeļkanāls d60 P-1, balts Kabeļkanāls d60 P-2, melns Kabeļkanāls d60 P-4, brūns Kabeļkanāls d60 P-6, dižskabārdis Kabeļkanāls d60 P-7, kļava Kabeļkanāls d80, dižskabārdis Kabeļkanāls d80, balts Kabeļkanāls d80, kļava Kabeļkanāls d80, brūns Kabeļkanāls d80, pelēks Kabeļkanāls d80, melns	0,273 0,273 0,273 0,273 0,273 0,357 0,357 0,357 0,357 0,357 0,357	
4750943012283 4750943012290 4750943012306 4750943012313 4750943012320 4750943012337 4750943012344 4750943012351	PM-60-2 PM-60-5 PM-60-6 PM-60-7 PM-80-2 PM-80-5 PM-80-6 PM-80-7	Kabeļkanāls metāla D-60, hromēts Kabeļkanāls metāla D-60, matēts niķelis Kabeļkanāls metāla D-60, matēts hroms Kabeļkanāls metāla D-60, slīpēts metāls (inox) Kabeļkanāls metāla D-60, hromēts Kabeļkanāls metāla D-60, matēts niķelis Kabeļkanāls metāla D-60, matēts hroms Kabeļkanāls metāla D-60, slīpēts metāls (inox)	1,483 1,483 1,483 1,483 1,653 1,653 1,653 1,653	
4750943005018	5000	Mēbeļu magnēts cilindrisks, balts	0,340	
4750943005025 4750943005032 4750943005049	5001 5002 5003	Mēbeļu magnēts ar plāksniti, brūns Mēbeļu magnēts ar plāksniti, melns Mēbeļu magnēts ar plāksniti, balts	0,122 0,122 0,122	
4750943012368	48-66	Līmlenta 55mic x 48mm x 66m	0,415	