

Titus Group
Technical Catalogue
and Manual



Furniture Fittings Systems

2017

Important Information

Technical information

While every effort has been made in the production of this catalogue to ensure the accuracy of information, our products are continually being revised and users should confirm the up to date specification before ordering. Due to constant improvement of products presented in the catalogue, we can make changes at any time and without notice.

Responsibility

It is the responsibility of the user to ensure the fitness of hardware for the intended purpose. We recommend assessment by appropriate testing in the application and by technical enquiry to our representatives.

Intellectual property

Titus Group owns the intellectual property rights in its products worldwide whether as trademarks, patents, intellectual, copyright, designs, illustrations, drawings and the 'know how' contained in their design and production. Titus Group respects the equivalent rights in competitors and all other relevant product design rights. To our knowledge our products do not infringe any intellectual property rights of competitors or other parties. Titus Group takes infringements of its rights seriously and will rigorously defend these rights to the full extent of the law.

***Non preferred articles**

All Item numbers in the catalogue marked with * are for non preferred items available on extended delivery times.

Trademarks

Titus and Titusonic are registered trademarks of Titus International Ltd. Lama is a registered trademark of Titus d.o.o. Dekani, WoodWelding is a registered trademark of WW SA.

Contents

1

2

3

4

5

Connectors

- System 1
- System 2
- System 3
- System 4
- System 5
- System 6
- System 7

1.1

1.7
1.11
1.15
1.17
1.23
1.45
1.57

Soft Closing Systems

- Information
- Glissando add-on hinge soft closing system
- Glissando stand-alone soft closing system
- Titusoft for drawers
- Titusoft for sliding doors

2.1

2.3
2.15
2.19
2.21
2.27

Concealed Hinges

- Information
- T-type Glissando, T-type
- S-type-i plus, S-type-i, S-type plus, S-type
- B-type-i, B-type
- Special hinges
- Push latch

3.1

3.3
3.27
3.57
3.105
3.145
3.149

Other Functional Fittings

4.1

The Titus Group Profile

5.1

Connectors

Connectors

Product Guide

Page

System 1

Fittings for rigid assembly systems

a highly cost-effective and rigid assembly system for factory, consumer and home assembly

1.7

System 2

Fittings for face-boring applications

face boring applications that provide a tolerant efficient assembly

1.11

System 3

Fittings for face and edge boring

two component rigid face and edge drilling fastening

1.15

System 4

Fittings for face-boring only

a range of low-cost one-piece fittings for high volume home assembly applications

1.17

System 5

Cams and dowels

a comprehensive range of cam and dowel connecting fittings for all cabinet applications

1.23

Page

System 6

Quickfit-Expando connectors

face boring expanding
connectors for all cabinet
applications

1.45

System 7

Heavy duty cams and dowels

high quality fittings for offices
and public furniture

1.57

Connectors

Information

Why Choose Titus?

Titus connectors add value to furniture and to furniture manufacturing

Titus connectors improve the quality of furniture and lower the cost of manufacturing and assembly while ensuring a high degree of customer satisfaction.

The most advanced range of connectors available on the market

Precise and efficient product design. **The broadest possible range of drilling tolerances** ensures reliable assembly and consistently strong joints. **'Klix'** locking feature, the engagement of interlocking teeth on cam and dowel, to prevent joint loosening in service or transit.

Expanding function provides degrees of variation in out-of-tolerance drillings ensuring stronger joints and improved quality of furniture.

Twinstart thread for faster and more stable insertion.

Depth stop collar prevents over-insertion.

Firm tightening for greater confidence in use.

Cam locks at 230° assuring smooth tightening action and greater dowel pull-up.

Quickfit for hand dowel insertion.

Quickfit TL5, new generation steel dowel with quickfit expando technology for insertion in Ø5mm dowel holes.

Quickfit TL2, TL4 with the built-in self adjustment feature for higher drilling tolerances.

Quickloc one piece fitting for faster assembly with integrated expanding cam and dowel.

Zinc+steel dowel for optimal strength and performance.

Precise dowel manufacturing high precision of zinc and strength of steel assures 100% dimensional accuracy.

Easy and quick consumer friendly self-assembly of furniture

Self-assembly furniture offers consumers good value and instant availability of products.

With the aim of providing consumer with simpler instructions, fewer parts and an easier assembly process, Titus has significantly reduced and simplified the number of fittings traditionally required in furniture production.

Titus connectors provide consumers with easy assembly and furniture producers with increased productivity:

- reduced number of assembly parts
- easy assembly instructions
- security of packed parts during transit

CAF Quick & Easy

Consumer Assembly Friendliness

Easy and Quick Furniture Assembly

CAF formula

CAF=Consumer Assembly Friendliness

Titus CAF formula provides a comparative measure for customer satisfaction. By using it manufacturers are able to evaluate their products internally or against those of their competitors.

While offering consumers easier and faster assembly, there are obvious advantages also for furniture manufacturers – buying, counting, bagging and stocking of fittings can be greatly reduced.

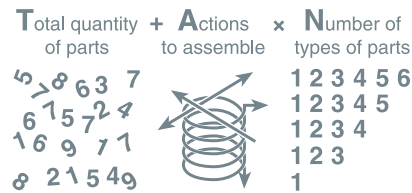

$$(T+A)N = CAF$$

Minimise the numbers in the Titus CAF™ formula to achieve:

- High customer satisfaction
- Improved productivity
- Higher profits

How does it work?

Comparative CAF scores to assemble a hand held demonstrator

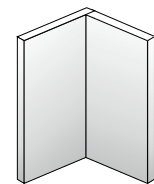

	T	A	N	CAF
Connecting screw (traditional assembly)	4	38	3	126
Cam & dowel with single start thread	6	21	4	108
Cam & dowel with twinstart thread	6	15	4	84
Cam & TL2 dowel (self-assembly)	6	7	4	52
Cam & TL2 dowel (factory pre-inserted)	2	3	2	10
Quickloc	2	3	1	5
Fully assembled demonstrator	1	0	1	1

System 1

Fittings for Rigid Assembly Systems

System Features

Double locking carcass screw

- Zinc diecast for precision
- Titus Double locking carcass screw makes an almost invisible connection
- Collar under the head to pull panels together
- 2nd 'lower' thread pulls against a 'faster' thread to provide maximum connection force and prevents overdriving of fastener
- Almost invisible in position
- Head can be 'fastcapped' or filled

Hi-Lo™ carcass construction screw

The Hi-Lo™ carcass construction screw (CCS) offers a strong, tolerant and cost effective connection with minimal panel preparation.

The combination effect of the elements of a Hi-Lo™ screw means

- A greater differential between drive torque and strip torque in fibrous and particle materials to ensure a reliable and repeatable fixing
- Hi-Lo™ threads provide minimum bursting forces
- 'Hi' thread gives low bursting component force from the sharp 30 degree angle thread
- 'Lo' thread at 60 degree angle uses the vertical force component to press fibrous and particle components of panels onto the 'Hi' thread and are contained by their greater height
- The very small shank on a Hi-Lo™ screw means less material displacement than conventional threads and enables minimum or partial drilling of pilot holes for quicker panel processing

Barrel nut (plastic)

- Used with Titus Hi-Lo™ screws
- Titus barrel nuts provide maximum strip torque for reasonable drive torque
- Capable of multiple reconnection repeatability

Cover caps

- Available in multiple colours
- All recess and head types offered
- High quality engineering polymers used in their construction
- Uniformity of holding with good tolerance
- Wide range of application and use conditions

System 1

Fittings for Rigid Assembly Systems

Double Locking Carcase Screw

- High performance from widely spaced primary thread
- Finer secondary thread provides additional holding power and positive stop (no override)
- Increased support for vertical panel is gained from the funnel head with collar at its base
- One-piece fitting

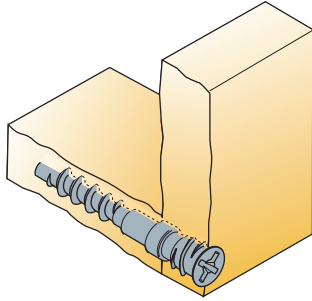

Technical and mounting details

Item number

Zinc

Screw 6x42

00180 →

885

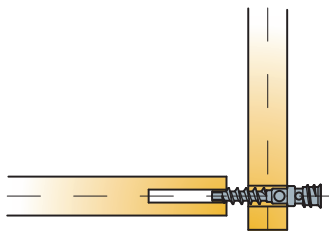
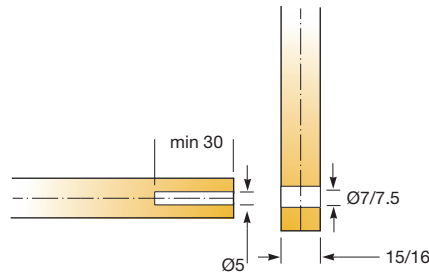
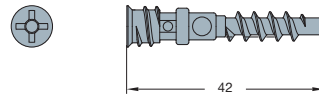

1. Insert screw to shoulder in face board

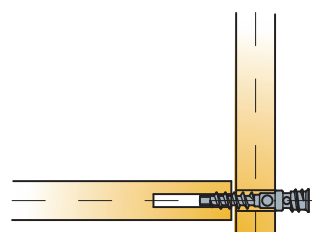

2. Screw into Ø5mm hole

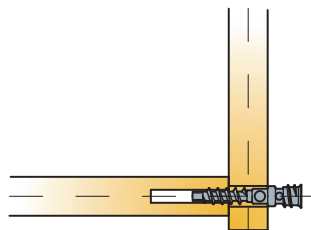

3. Board joint pulled up by collar on screw

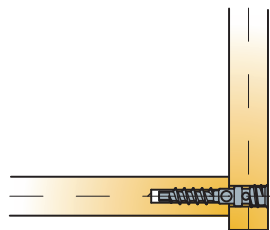

4. Board locked in place by screw



1000 Pcs

Made of zinc

System 1

Fittings for Rigid Assembly Systems

Hi-Lo™ Screw and Barrel Nut

- Hi-Lo™ screws have a twin thread for faster insertion
- 'Hi' threads and 'Lo' threads combine to give excellent pull out in chipboard
- Funnel head design means no countersinking
- Steel is case hardened for extra strength

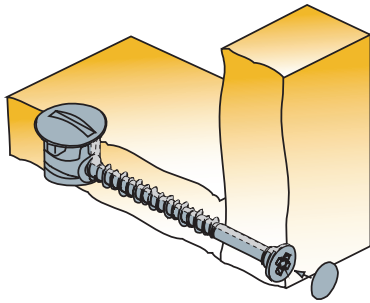

Technical and mounting details

Hi-Lo™ screw

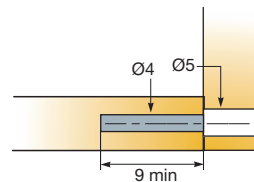
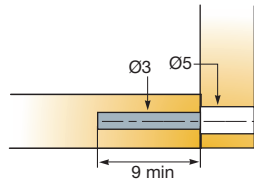
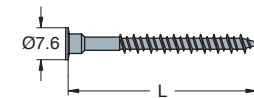

- 10000 Pcs (00062)
 - 9000 Pcs (00068)
 - 7000 Pcs (00071)
 - 4000 Pcs (00077, 00171, 06074)
 - 3000 Pcs (00172, 06077, 06080)
- Made of steel

Barrel nut

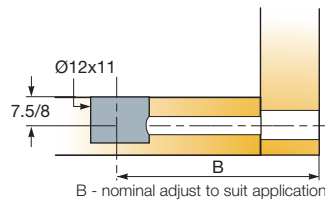

- 10000 Pcs
- Made of plastic

Screw cap

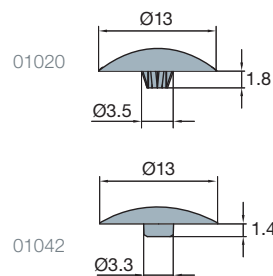





- 10000 Pcs (01042)
 - 5000 Pcs (01020)
- Made of plastic

Screw diameter	B	L	Drive type	Item number	Colour		
					Black	Phosphate	White
4		24		*00062 →	852		
4		28		*00068 →	852		
4		33		00071 →	852		
4	32	45		00177 →	852		
4	32	45		*00171 →	852		
4	32	55		00072 →	852		
4		38		06074 →	852		
4	32	50		*06077 →	852		
5	32	50		*06080 →	852		
Drive type				<i>*American market only</i>			
hexagonal drive		cross slot					
				01056 →	835		877
<i>Other colours on request</i>							
			pozi, philips drive	01020 →	835		877
			hexagonal drive	01042 →	835		877
<i>Other colours on request</i>							

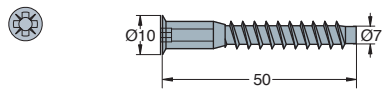
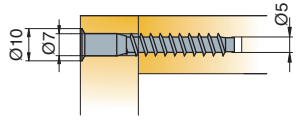
System 1 Connecting Screws

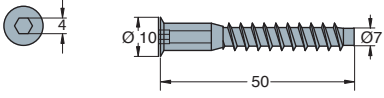
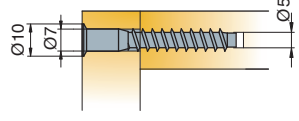
- Screws with crosshead PZ2 screwdriver or allen key slot
- Decorative cover caps are available in different colours

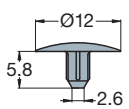
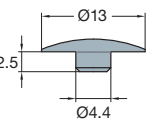
Technical and mounting details		Item number	Zinc plated	Ochre	White
<p>Crosshead screwdriver slot</p>   		827-6202 →	040		
 1000 Pcs <p>Made of steel</p>					
<p>Allen-key slot</p>   		827-6201 →	040		
 1000 Pcs <p>Made of steel</p>					
<p>Cover caps for connecting screws</p>   	<p>Universal</p> <p>For allen key slot head</p>	827-4013 →		330	350
<p>1000 Pcs (827-4130) 2000 Pcs (827-4013)</p> <p>Made of plastic</p>		827-4130 →		330	350

System 2 Fittings for Face-boring Applications

System Features

A family of face boring only concealed fittings and rail fasteners with wide tolerances and the enormous clamping power of an angled screw.

- Factory or site component installation
- Wide tolerances
- Face boring only
- Cover caps for concealment
- For kitchen, furniture storage, office and store fixture applications
- Non twist rail fastener versions
- Multi use 'pocket screw' replacement

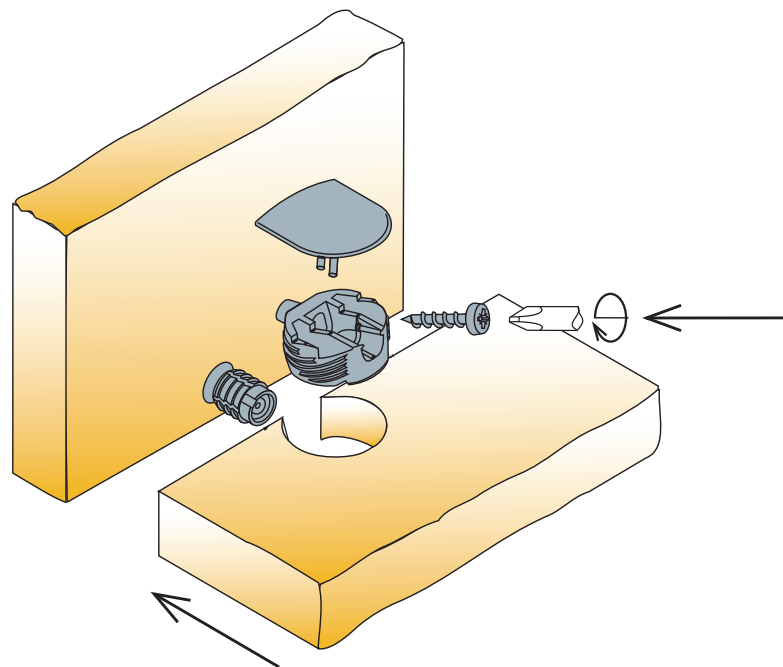

System 2 Fittings for Face-boring Applications Concealed Fittings

- Combination of hi-thread screw and nylon insert allows a high clamping force improving cabinet rigidity
- Unlimited stacking height due to flush housing
- Provides a strong, secure fitting which eliminates the need for edge boring
- +/-1mm tolerance absorbs drilling inaccuracies improving consumer confidence in use

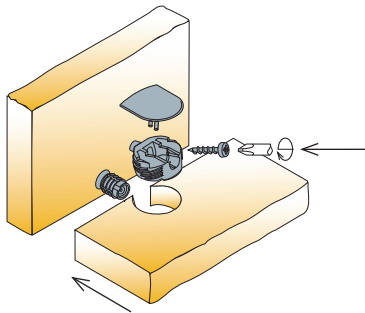

Technical and mounting details

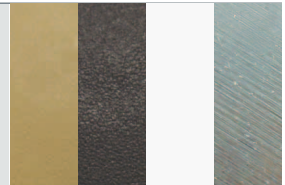

Brown beige

Black

White

Zinc plated

Item number

Housing assembly



2500 Pcs

Made of plastic, steel

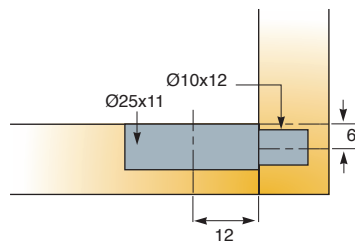

02046 →

835

877

Housing (no nose)



2500 Pcs

Made of plastic

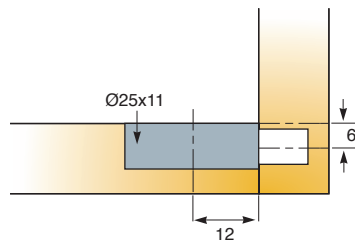

*02985 →

877

*European market only

Screw panhead
No 8 x 17.6



15000 Pcs

Made of steel

01709 →

883

Cover cap



7000 Pcs

Made of plastic

01732 →

806

877

Other colours on request

Inserts
Made of plastic

→ see page 1.62

System 2 Fittings for Face-boring Applications

- Range of fixing blocks for multiple applications
- Face drilling only required
- Durable plastic material is flexible providing greater holding power
- Choose screw fastening or hammer insertion

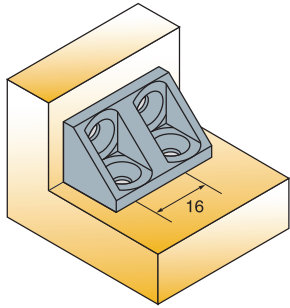

Technical and mounting details

Item number	Color options			
	Dark brown	Light brown	Ivory	White

Rail fastener

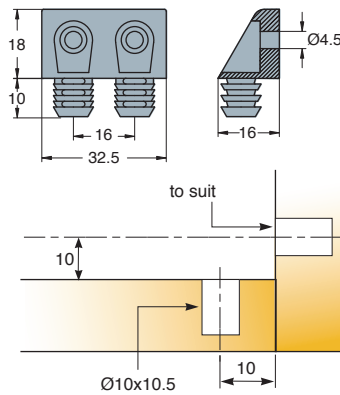

02075 →	831	867		877
---------	-----	-----	--	-----

2000 Pcs

Made of plastic

Housing (no nose)

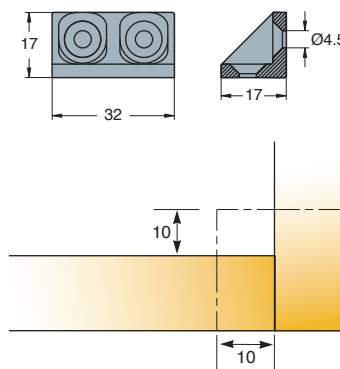

02077 →			875	877
---------	--	--	-----	-----

2000 Pcs

Made of plastic

Modesty block

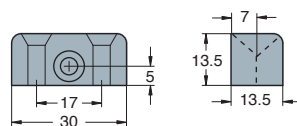

*06073 →		867		877
----------	--	-----	--	-----

*European market only

1500 Pcs

Made of plastic

System 3

Fittings for Face and Edge Boring

System Features





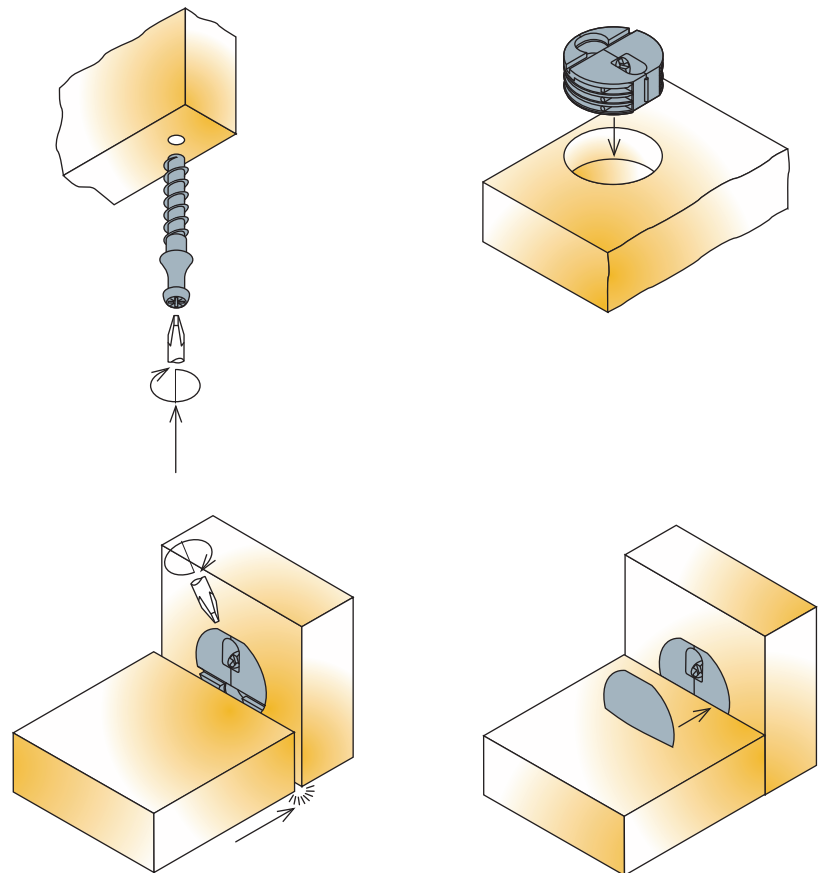

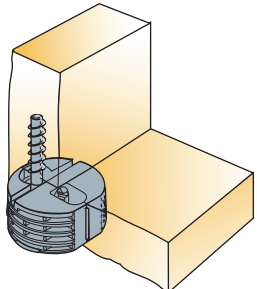

Titus System 3 is a two component rigid face and edge drilled fastening with half turn to fasten. System 3 offers almost full concealment and wide tolerances in use.

- Automatic or in-factory placement
- Pre-location pin ensures ease of assembly
- Less than one turn of a screwdriver to fasten
- Shelf edge installation of pin means maximum shelf cut size tolerance
- Can be used on 12mm shelf panels
- No loose parts for maximum convenience in RTA
- Drawer front fixing, cabinet construction

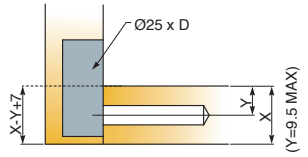

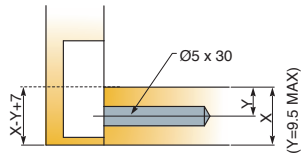
System 3 Fittings for Face and Edge Boring Concealed Housing

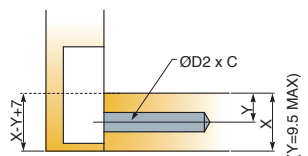
- One turn locking system reduces assembly time, both in the factory and home
- Pre-assembly feature for consumer convenience
- Choice of dowels to suit drilling
- Hi-Lo screw feature for faster insertion

Technical and mounting details		C	D	D2						
		Drilling length for dowel	Drilling depth	Drilling diameter for dowel thread	Item number	Black	Zinc plated	Yellow passivate	White	
Housing assembly   2500 Pcs Made of plastic or zinc, plastic	 X, Y - depends on board thickness	12.5			03118 →	835			877	
		11			03121 →	835				
<i>Other colours on request</i>										
Screw dowel Ø5   1000 Pcs Made of steel	 X, Y - depends on board thickness				03168 →		883			
		<i>*American market only</i>								
Screw dowel Ø3   5000 Pcs (03180) 4000 Pcs (03181) 1000 Pcs (03190) Made of steel	 X, Y - depends on board thickness	30		3.75	03181 →				881	
		9		3	03180 →					881
		25		3	*03090 →			883		
<i>*American market only</i>										
Cover cap   15000 Pcs Made of plastic					03150 →	835			877	

System 4 Fittings for Face-boring Only

System Features

Cost effective one piece fittings with face boring benefits

- Flush and block components
- Face-boring only
- Good tolerances
- One piece connectors
- Angledriv versions fastening with maximum driving power and flexibility
- Quickloc™ versions need only one turn to tighten for fast assembly
- Foolproof consumer home insertion

Quickloc™ One-piece connector

The integrated housing and dowel make Quickloc™ the most user-friendly and tolerant product available.

- High degree of drilling tolerance
- Push-in design
- Tool-free insertion
- Integrated expanding housing and dowel provide consistently stronger joints
- 'Klix' locking system

Quickloc™ Assembly

1. Press Quickloc into the face board

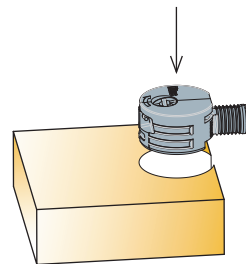

2. Assemble the panels

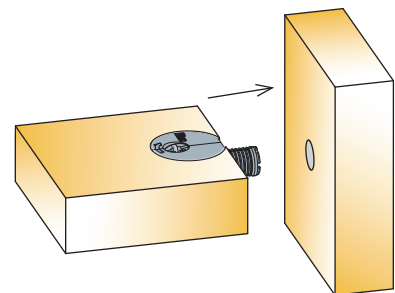



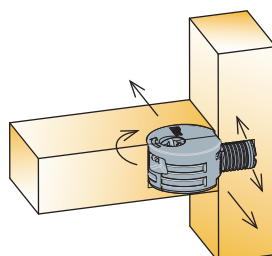





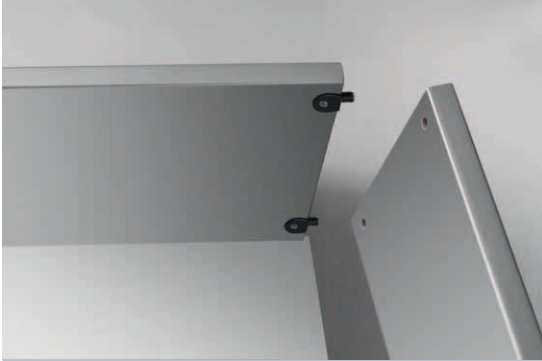
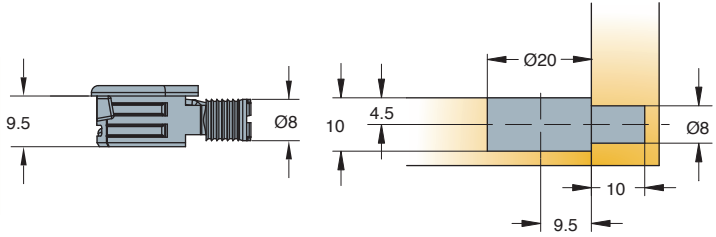

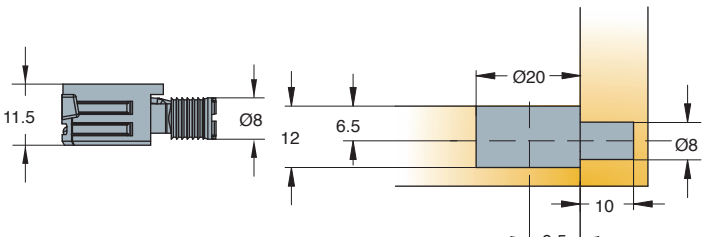
3. Tighten in less than one turn

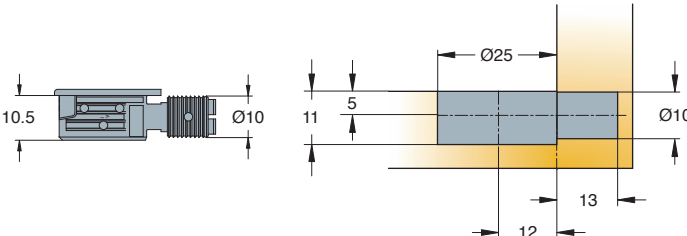

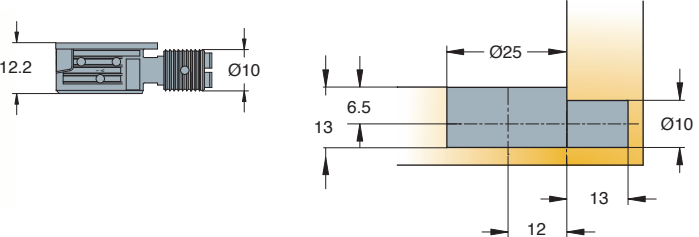
System 4 Quickloc™ One Piece Expanding Connector







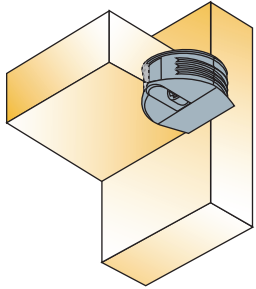

- An innovative, one-piece connector, capable of hand insertion
- Is highly tolerant and tightens in less than one turn
- Is a face-bored product
- Offers a high degree of drilling tolerance and is the only connector of its type to provide pull-up of cabinet panels when tightened

Technical and mounting details		Color options			
		Dark brown	Black	White	
		Item number	Dark brown	Black	White
Quickloc Ø20 flanged 		06803 →	831	835	877
 2500 Pcs	Made of zinc, plastic				
Quickloc Ø20 flush 		06806 →	831	835	877
 2500 Pcs	Made of zinc, plastic				
Quickloc Ø25 flanged 		06813 →	831	835	877
 1500 Pcs	Made of zinc, plastic				
Quickloc Ø25 flush 		06839 →	831	835	877
 1500 Pcs	Made of zinc, plastic				

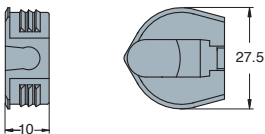
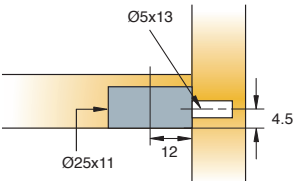
System 4 Fittings for Face-boring Only

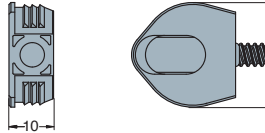
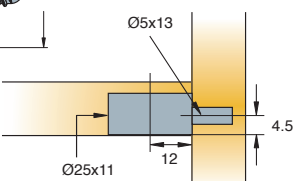
Flushbloc™ / Flushfix™

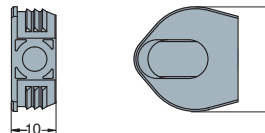
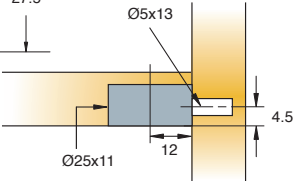

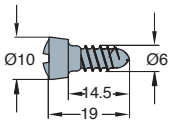
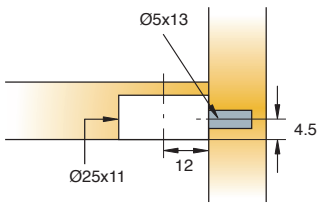





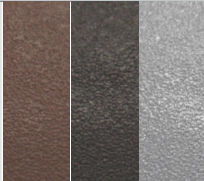

- The Angeldriv screw provides high level of tolerance
- Face drilling only required
- Corner joint and shelf fixing options

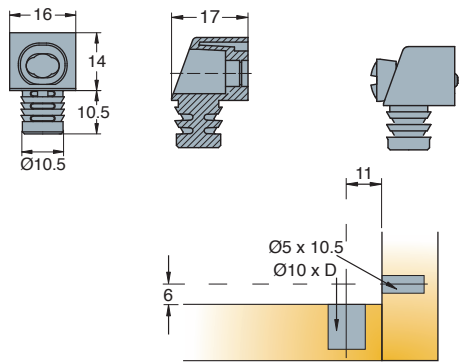
						
		Brown beige	Black	Silver	White	Zinc
		<p>Technical and mounting details</p>				
<p>Flushfix™</p>   		<p>Item number</p> <p>02161 →</p>	806	861	877	
<p>2500 Pcs</p> <p>Made of plastic</p>		<p>Other colours on request</p>				
<p>Flushbloc™ with screw</p>   		<p>Item number</p> <p>02193 →</p>		835	877	
<p>2000 Pcs</p> <p>Made of zinc and plastic</p>		<p>Other colours on request</p>				
<p>Flushbloc™ assembly</p>   		<p>Item number</p> <p>*02190 →</p>		835	877	
<p>2500 Pcs</p> <p>Made of plastic</p>		<p>* American market only Other colours on request</p>				
<p>Angeldriv screw for use with Flushfix™</p>   		<p>Item number</p> <p>00021 →</p> <p>00022 →</p>				885
<p>2000 Pcs (00021)</p> <p>4000 Pcs (00022)</p> <p>Made of zinc</p>						

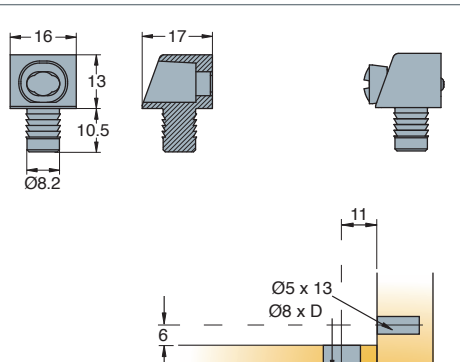
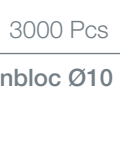
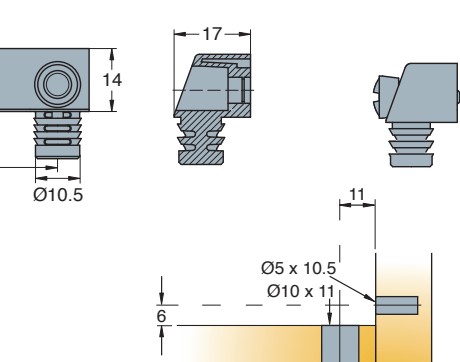
System 4 Fittings for Face-boring Only

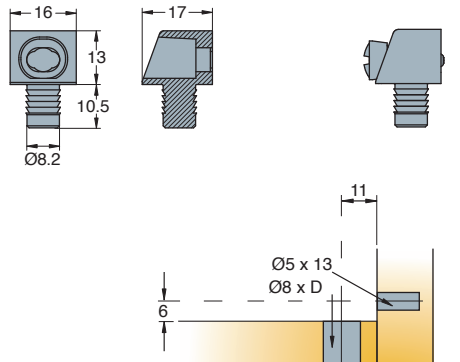
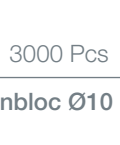
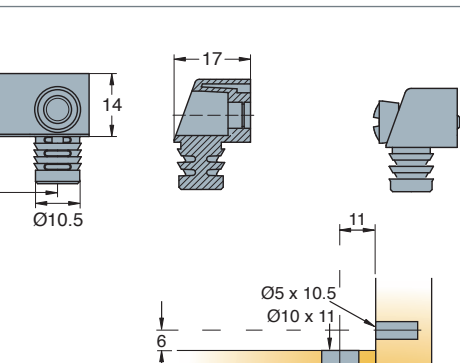
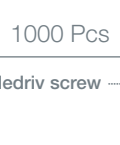
Minibloc™ / Twinbloc™

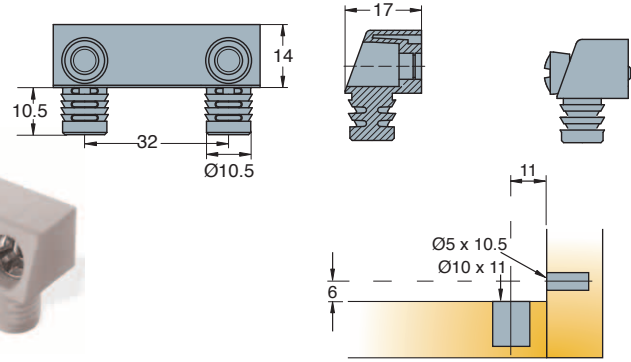
- One-piece connector range
- Face drilling only required
- Easy to use, foolproof home insertion
- Angledriv screw tolerates good levels of inaccurate drilling increasing consumer confidence

Technical and mounting details		D					
		Drilling depth	Dark brown	Black	Silver	White	
		Item number					
Minibloc Ø10  		11	02107 →	831	835	861	877
 		11	* 02120 →	831	835	861	877
 		* assembly with screw Other colours on request					
2500 Pcs (02107) 3000 Pcs (02120) Made of zinc, plastic							
Minibloc Ø8  		11	02141 →		835	861	877
 		11	* 02144 →		835		877
 		* assembly with screw *European market only Other colours on request					
3000 Pcs Made of zinc, plastic							
Twinbloc Ø10  		11	02130 →		835	861	877
 		11	* 02139 →		835		877
		* assembly with screw Other colours on request					
1000 Pcs Made of zinc, plastic							

Angledriv screw → see page 1.19

System 4

Fittings for Face-boring Only

Knock-down Fittings

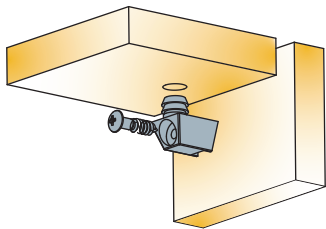

Technical and mounting details

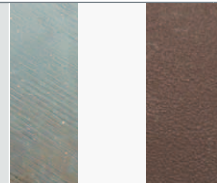

Zinc plated

White

Brown

Item number

Fitting

278-4129 →

350

370

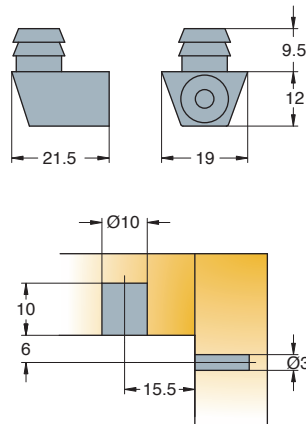

 5000 Pcs Made of plastic

Screw

825-7561 →

040

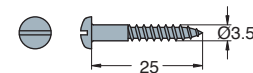

 5000 Pcs Made of steel

System 4 Fittings for Face-boring Only Cambloc

- Screw-on and knock-in versions are available
- Plastic housings are available in different colours
- Quick and intuitive assembly when fittings are pre-mounted on furniture

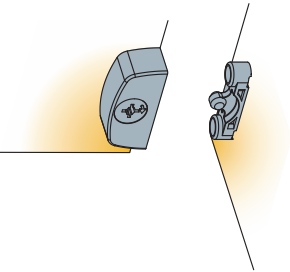

Technical and mounting details

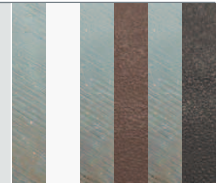

Item number	Zinc plated + white housing	Zinc plated + brown housing	Zinc plated + black housing
-------------	-----------------------------	-----------------------------	-----------------------------

Screw-on

279-9187 →

960

970

980

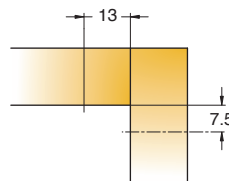
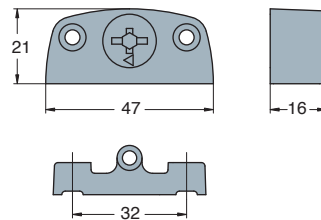

1000 Pcs

Made of plastic, zinc cam

Knock-in

279-9465 →

960

970

980

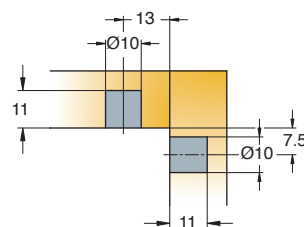
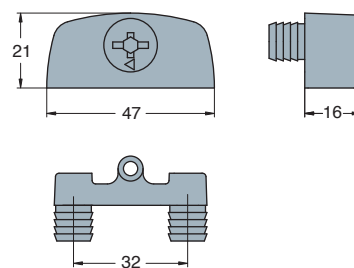

500 Pcs

Made of plastic, zinc cam

System 5 Cams and Dowels

System Features

The most advanced cam and dowel range

Titus System 5 is a comprehensive range of cam and dowel connecting fittings with 'Klix' and Quickfit features for all cabinet applications: panel-to-panel, panel-to-hollow profile, back-to-back

Dowels

- **Quickfit TL5, 'Full metal jacket'**
Tool-free insertion technology for Ø5mm dowel holes
- **Quickfit TL2, TL4, TL5 dowels**
a unique solution for factory pre-insertion, high level of drilling tolerances
- **Quickfit dowels**
quick hand insertion, easy assembly
- **Diecast dowels (zinc)**
precise manufacturing, optimal shape and design
- **Turned dowels (steel)**
'traditional' design, smooth surface, best strength performance
- **Combi dowels (zinc and steel)**
high precision of zinc, strength of steel, 100% dimensional accuracy and optimal performance

Titus 'Klix'™

Titus 'Klix' locking system ensures the engagement of the interlocking teeth on cam and dowel providing:

- vibration-proof joint
- rigid construction that will not loosen in service or transit

Dowel insertion time comparison

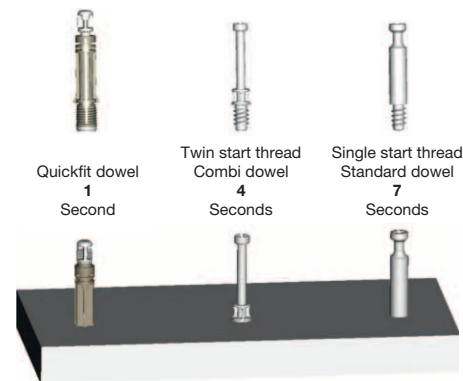

2 o'clock lock Smooth closing

Linear cam profile assures smooth, firm tightening action and greater pull-up. The cam always locks at 2 o'clock lock (230°), enabling greater consumer confidence in use while improving furniture quality.

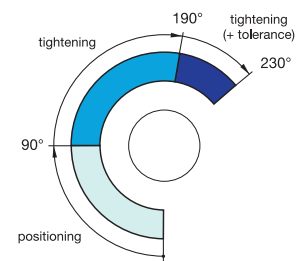

Drilling tolerances

Optimal performance and perfect joint even with inaccurate drillings.

Zinc/Combi dowel

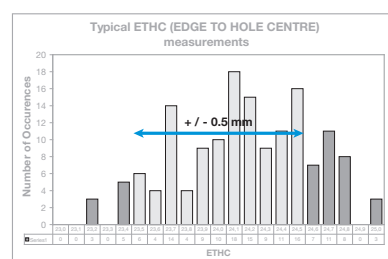
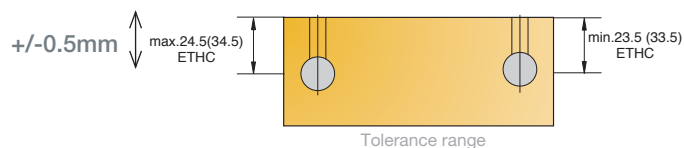

Quickfit TL5 dowel, Quickfit TL2 dowel

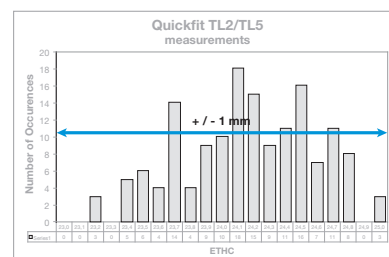
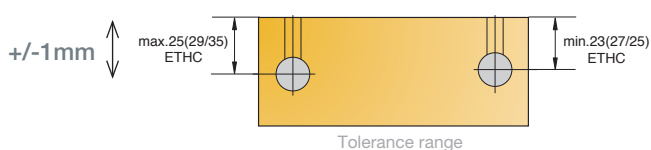

Quickfit TL4 dowel

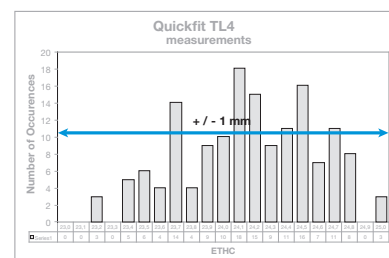
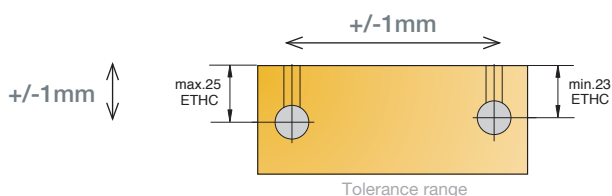

ETHC=Edge To Hole Center

Dowels for factory insertion

Quickfit TL5, Quickfit TL2 and Quickfit TL4 are the only available dowels that allow for factory preinsertion

- Easier packing
- Less damages in handling
- Perfect for the RTA market

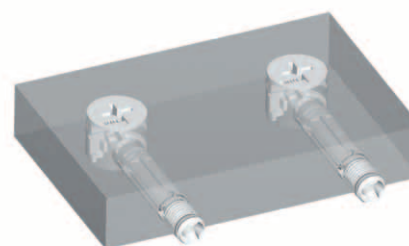

System 5 Cams and Dowels

Cam5000

Universal cam

New Cam5000 works with all Titus parallel neck dowels enabling simple stock management and greater confidence in use.

Highly resistant central shape

Shape of the cam body is redesigned to prevent the cam toroidal deformation or breakage in panel while tightening. The Cam5000 high resistance enables strong and reliable joint.



Linear cam profile

Linear cam profile ensures:

- Smooth tightening action
- Greater dowel pull-up



Optimised cam profile

Optimised cam profile ensures smooth and tight joint with no gap between panels.

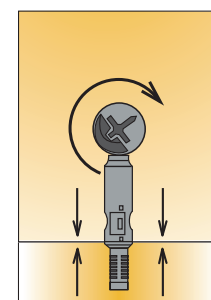

2 o'clock lock

The cam always locks at 2 o'clock (230°), enabling greater consumer confidence in use while improving furniture quality.

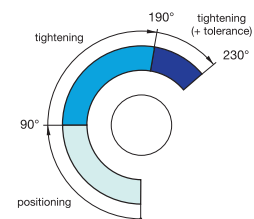

Cam retaining pips

Cam retaining pips assures:

- The cam is held in position prior to assembly
- Secure cam positioning during transport and handling
- Accurate factory insertion



Zinc+steel Combi Dowels

Zinc+steel technology for optimal strength and performance

The Combi dowel combines steel and a small amount of zinc to ensure high precision and dimensional accuracy, essential to provide furniture manufacturers with the broadest possible range of drilling tolerances.

toroidal head form

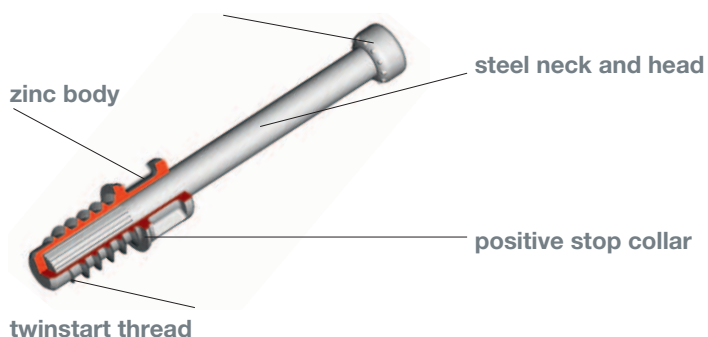

The steel neck and head provide better resistance to torsion and pull-out enabling a high performance joint

Zinc body:
Positive stop collar ensures correct insertion depth
Twinstart for faster and more stable insertion

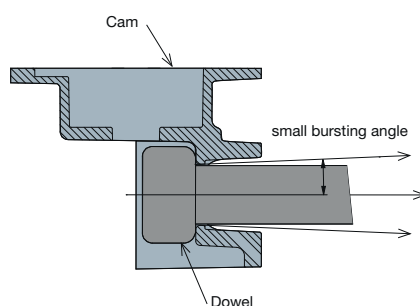

The toroidal dowel head form transfers the forces between cam and dowel more effectively resulting in a small cam bursting force.

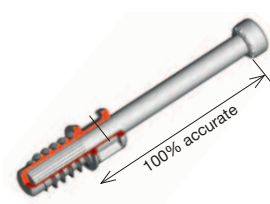

100% dimensional accuracy assured

System 5 Cams and Dowels

Quickfit Connectors

It is the fastest assembly system on the market. The Quickfit™ dowel may be inserted by hand, using only finger pressure. This eliminates the labour intensive process of screw-in assembly and the potential panel damage.

The Quickfit™ range of dowels has been extended to provide a complete family of fittings available in diameters of 5mm, 8mm and 10mm and lengths of 24mm and 34mm. These dowels are compatible with the range of TitusØ15mm cams.

Assembly

1. Press the cam into face board

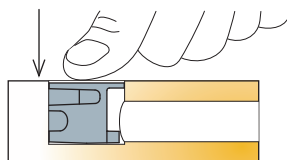

2. Insert the dowel into side panel

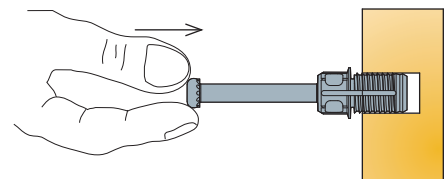

3. Assemble the panels

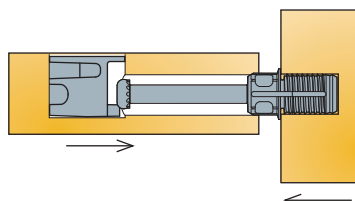

4. Tighten the cam to lock dowel

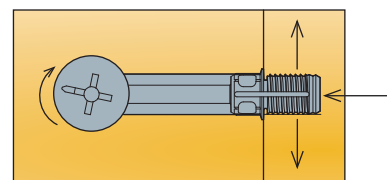
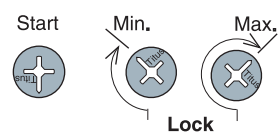

5. Assembled panels

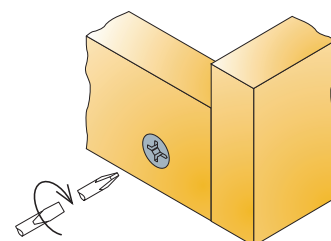

Quickfit TL Connectors

Quickfit-TL™ dowel offers furniture manufacturers a fast assembly system providing high drilling tolerances. It has a built-in self-adjustment feature, which enables common drilling inaccuracies to be overcome.

For the self-assembly furniture consumer, Titus Quickfit-TL™ is the most consumer friendly fitting on the market. Apart from the benefit of fully tightened joints and easy locking into the same position, Quickfit-TL™ provides an exceptionally smooth action when tightened, requiring very little effort.

Drilling tolerances

Marginal inconsistencies of drilling and the problems associated with the natural movement of wood panels, no longer present problems.

Quickfit-TL™ provides a tolerance of $+1/-1$ mm on drilling operation while ensuring that the final result is a perfectly precise and aligned joint. No other assembly fittings system can offer such tolerances and still maintain a perfect joint.

Assembly

1. Press the cam into face board

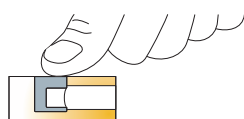

2a. Either push dowel into edge hole or...

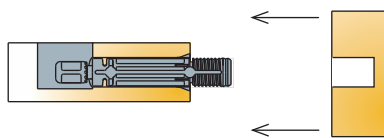

2b. Insert the dowel into side panel

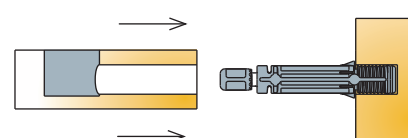

3. Assemble the panels

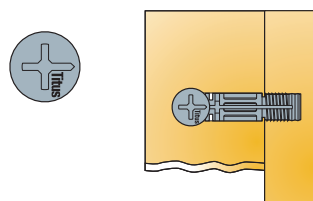

4. Tighten cam to lock dowel

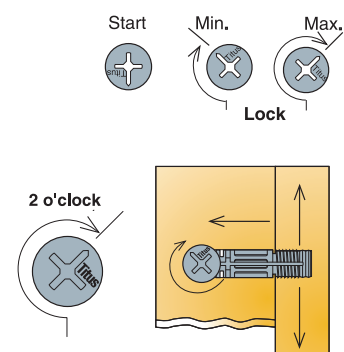

System 5 Cams and Dowels

Quickfit TL5

'Full metal jacket'

Quickfit TL5 with expanding steel sleeve is the new generation of Titus Quickfit TL dowels. It expands the Titus Quickfit tool-free insertion technology to widely used $\text{\O}5\text{mm}$ dowel holes.

Tool-free insertion for $\text{\O}5\text{mm}$ dowel holes

Unique at the market

- Easy to push in
- Works without wooden dowels

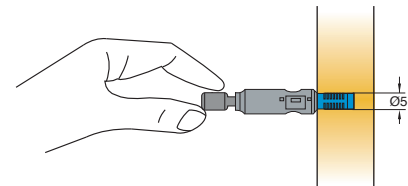

Expanding steel sleeve

Expanding steel sleeve assures high resistance to torsion and pull-out.

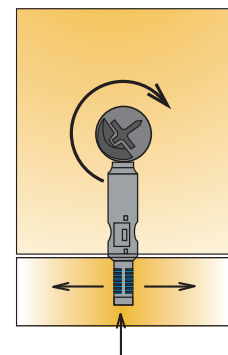

High drilling tolerances

Extended dowel head form works as a positive stop against cam and provides tolerances of $-/+1\text{mm}$ on drilling operation.

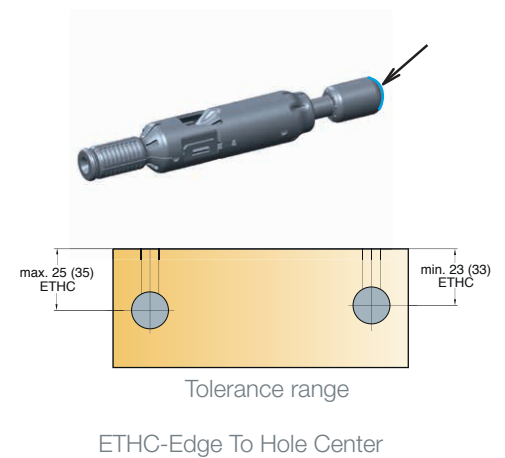

Shape of dowel sleeve

- Acts as a positive stop when face inserted
- Ensures correct insertion depth



50% less time to assemble the cabinet with factory insertion

Quickfit TL5 dowel is inserted into the panel by simply pushing the head of the dowel into the edge hole until it engages with the cam. It remains in this position until the cam is rotated to lock the boards together.

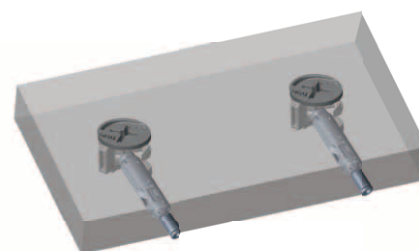

For a maximum efficiency the insertion process can be automated using the Titus proprietary Lama FastFit machine.

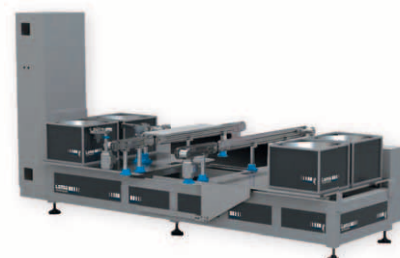

Functions with multiple wooden materials

- Functions with multiple wooden materials: chipboard, MDF, solid wood
- Improved performance in low density boards
- Assures strong and reliable joint

System 5

Quickfit TL5

'Full Metal Jacket'

- Tool-free insertion technology for Ø5mm dowel holes
- To be used with Cam5000 only
- Drilling tolerances of +1/-1mm when edge or face inserted
- Expanding steel sleeve assures a strong joint, highly resistant to pull-out
- Functions in multiple wooden materials (chipboard, MDF, solid wood)

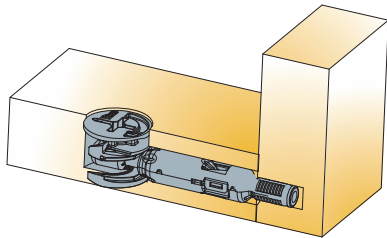

Technical details

Quickfit TL5 dowel

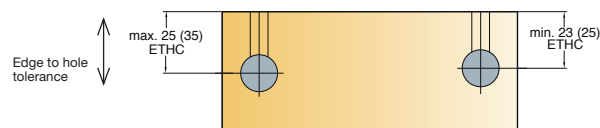
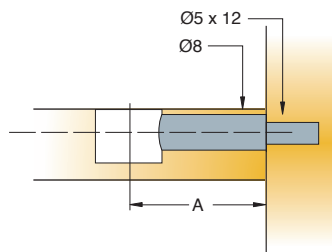

Tolerance range

Drilling distance	Item number	Zinc corrosion
A		
34	09652 →	897
24	09651 →	897

2000 Pcs

Made of steel

System 5

Cams and Dowels

Quickfit TL Dowels

- Available in Ø5mm and Ø8mm for panel-to-panel applications
- Suitable for use with all Ø15mm Cam2000, Cam3000 and Cam5000 products
- 'Klix' locking feature provides a strong, vibration proof joint
- Highly tolerant in edge-inserted, TL4 also in face-inserted applications

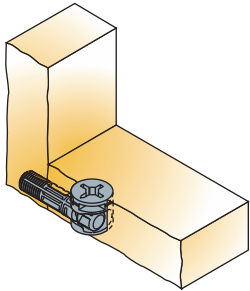

Technical and mounting details

A	D2	Item number		
			Black	Dark grey
Drilling distance	Drilling diameter for dowel thread			
24	5	05453 →		880
34	5	05503 →		880
24	8	05441 →		880
28	8	05314 →		880
34	8	05474 →		880

Quickfit TL2

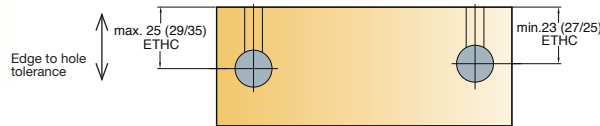
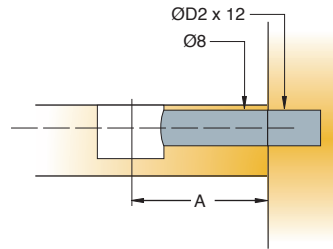

Tolerance range



2000 Pcs
1000 Pcs (05474) Made of zinc, plastic

Quickfit TL4

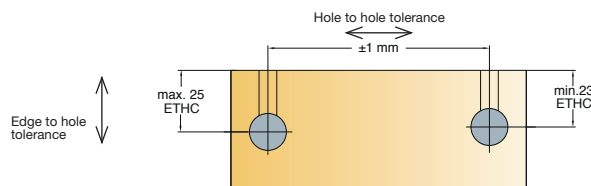
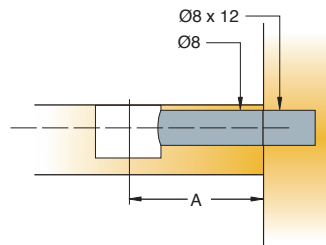

Tolerance range











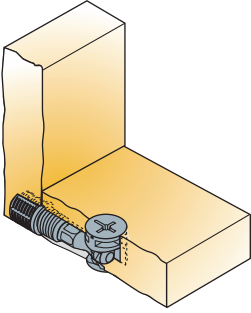
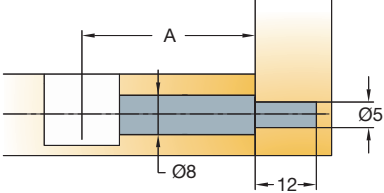

2000 Pcs Made of zinc, plastic

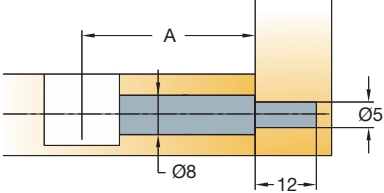
System 5

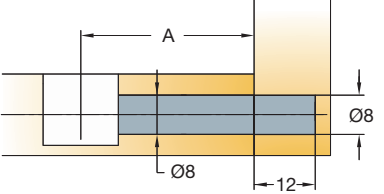
Cams and Dowels

Quickfit Dowels

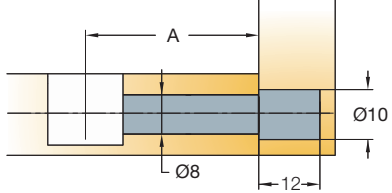
- Available in Ø5mm, Ø8mm and Ø10mm for panel-to-panel applications
- Suitable for use with all Ø15mm Cam2000, Cam3000 and Cam5000 products
- 'Klix' locking feature provides a strong, vibration proof joint
- Depth stop collar for accurate insertion

		A		
Technical and mounting details		Drilling distance	Item number	Dark grey
		24	05714 →	880
		34	05685 →	880
				
 2000 Pcs	Made of zinc, plastic			
		20	05556 →	880
		24	05563 →	880
		28	05552 →	880
		34	05554 →	880
 1000 Pcs (05556, 05552)  2000 Pcs (05563, 05554)	Made of zinc, plastic			
		24	05137 →	880
		24	*05570 →	880
		34	05129 →	880
 1500 Pcs (05129)  2000 Pcs (05570)	Made of zinc, plastic			

System 5

Cams and Dowels

Quickfit P2F Dowels

- The only product to enable standard panel drilling and connection of panel and hollow profile
- Available in Ø8mm for panel-to-hollow profile applications
- Suitable for use with all Ø15mm Cam2000, Cam3000 and Cam5000 products
- 'Klix' locking feature provides a strong, vibration proof joint

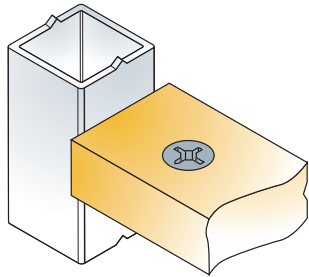

Technical and mounting details

Quickfit P2F

A

Drilling distance

Item number

Black

24

05414 →

835

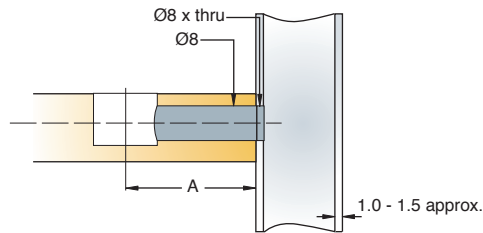
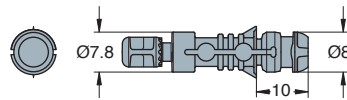



System 5

Cams and Dowels

Combi Dowel

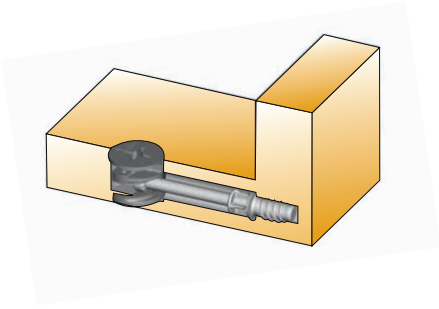
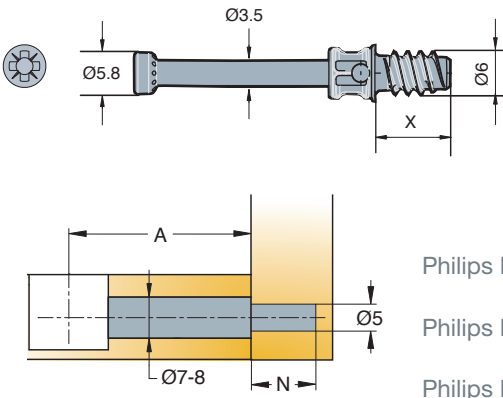
- High quality zinc-steel dowel with greater resistance to torsion and pull-out
- Suitable for use with all Ø12mm and Ø15mm Cam2000, Cam3000 and Cam5000 products
- 'Klix' locking feature provides a strong, vibration proof joint
- Twinstart thread for faster and reliable insertion

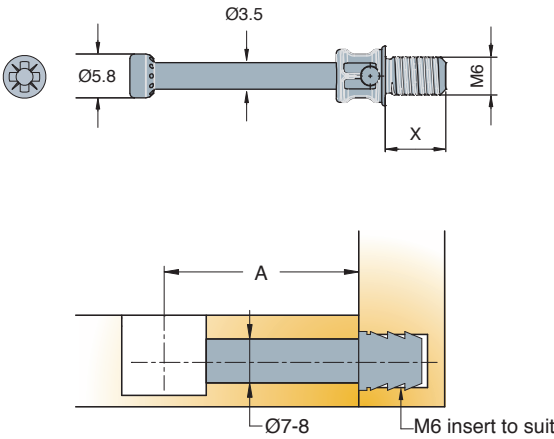
Technical and mounting details		A	N	X	Item number	Zinc
		Drilling distance	Drilling depth	Thread length		
 <p>Combi dowel Ø5</p>  <p>Philips PH2 head</p> <p>Philips PH2 head</p> <p>Philips PH2 head</p> <p>1000 Pcs *2000 Pcs</p> <p>Made of steel and zinc</p>	34	12	11	09435 →	885	
	28	10	9.5	09588 →	885	
	24	12	11	09443 →	885	
	24	9	8.5	09583 →	885	
	34	12	11	*09424 →	885	
	24	12	11	*09423 →	885	
	34	9	8.5	*09456 →	885	
<p>Combi dowel M6</p>   <p>M6 insert to suit</p> <p>1000 Pcs</p> <p>Made of steel and zinc</p>	34		8	09592 →	885	
	34		10.5	09594 →	885	



→ see page 1.61







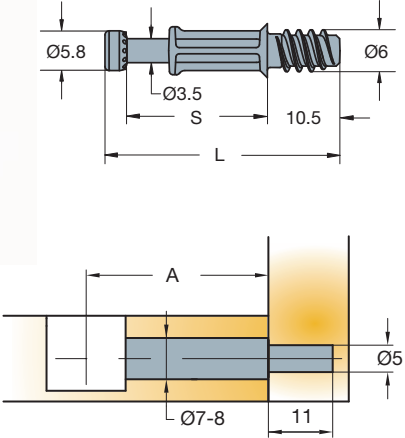

→ see page 1.62

System 5

Cams and Dowels

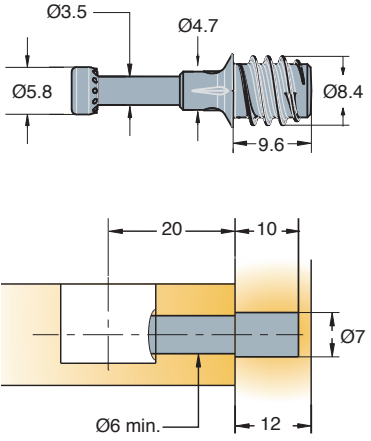
Combi Dowel

		S	L	A		
Technical and mounting details				Drilling distance	Item number	Zinc
<p>Combi dowel Ø5 Full body</p>  	PZ2 head 	20.6	34.5	24	09597 →	885
 2000 Pcs	Made of steel and zinc					
<p>Combi dowel Ø7</p>  	Philips PH2 head 			20	09430 →	885
 1000 Pcs	Made of steel and zinc					

 Inserts
Made of plastic

→ see page 1.62

System 5

Cams and Dowels

Double-ended Dowel

- Available in Ø7mm
- Suitable for use with all Ø12mm and Ø15mm Cam2000, Cam3000 and Cam5000 products
- No circlip for increased tolerance
- Available in a variety of lengths to suit most panel-to-panel applications

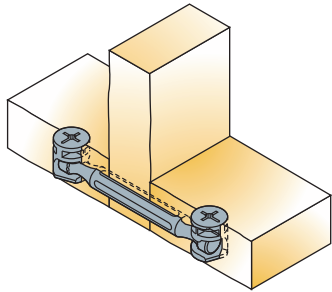

Technical and mounting details

Dowel without circlip

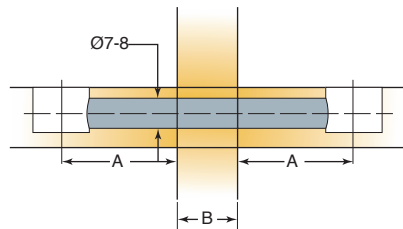
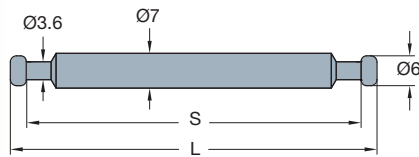

250 Pcs (05753)
500 Pcs
1000 Pcs (05929,05857)

Made of steel

Dowel with circlip

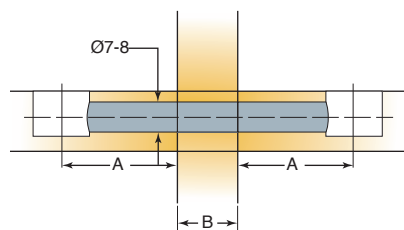
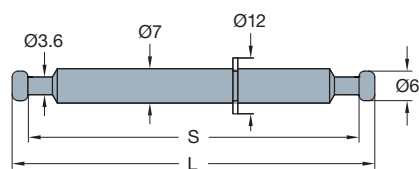

250 Pcs
500 Pcs (05775, 05774)

Made of steel

S	L	A	B	Item number	Zinc plated
		Drilling distance	Panel thickness		
41	47.4	24	0*	05929 →	883
61	67.4	34	0*	05757 →	883
77	83.4	34	16	05858 →	883
79	85.4	34	18	05859 →	883
80	86.4	34	19	05753 →	883
56	62.4	24	15	05592 →	883
57	63.4	24	16	05857 →	883
59	65.4	24	18	05380 →	883
60	66.4	24	19	05778 →	883
*B=0 → no panel required					
77	83.4	34	16	05752 →	883
79	85.4	34	18	05772 →	883
80	86.4	34	19	05751 →	883
57	63.4	24	16	05775 →	883
60	66.4	24	19	05774 →	883

System 5

Cams and Dowels

Angled Dowels

- Suitable for applications requiring angled joints
- Suitable for use with all Ø12mm and Ø15mm Cam2000, Cam3000 and Cam5000 products
- Adjustable angle from 90° to 180°

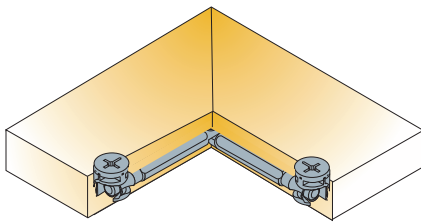

Technical and mounting details

Item number

Zinc plated

Angled dowel

05860 →

883

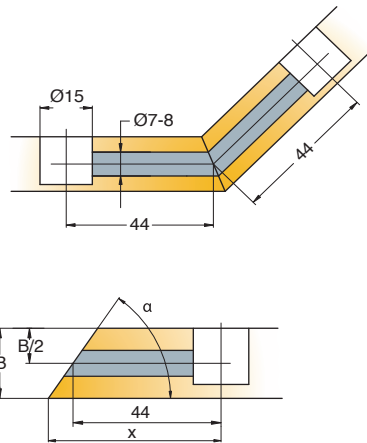

Distance x in mm

α	20°	25°	30°	35°	40°	45°	50°	55°	60°	65°	67,5°	70°	75°	80°	85°
13	61.9	57.9	55.3	53.5	51.7	50.5	49.5	48.6	47.8	47	46.7	46.4	45.7	45.1	44.6
15	64.6	60.1	57	54.7	52.9	51.5	50.3	49.3	48.3	47.5	47.1	46.7	46	45.3	44.7
16	66	61.2	57.9	55.4	53.5	52	50.7	49.6	48.6	47.7	47.3	46.9	46.1	45.4	44.7
B 18	68.8	63.3	59.6	56.9	54.7	53	51.6	50.3	49.2	48.2	47.7	47.3	46.4	45.6	44.8
19	70.1	64.4	60.5	57.6	55.3	53.5	52	50.7	49.5	48.4	47.9	47.5	46.5	45.7	44.8
22	74.2	67.6	63.1	59.7	57.1	55	53.2	51.7	50.4	49.1	48.6	48	46.9	45.9	45
23	75.6	68.7	63.9	60.4	57.7	55.5	53.6	52.1	50.6	49.4	48.8	48.2	47.1	46	45 x

250 Pcs

Made of steel

System 5

Cams and Dowels

End Dowels

- Available in a variety of head and length combinations to suit most end panel applications
- Suitable for use with all Ø12mm and Ø15mm Cam2000, Cam3000 and Cam5000 products
- 'Klix' locking feature provides a strong, vibration proof joint
- Both 'mushroom' and countersunk headed versions available

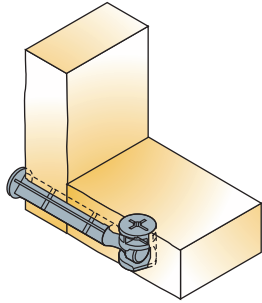

Technical and mounting details

A	B	S	L	Item number	Zinc
Drilling distance	Panel thickness	Length	Total length		
24	16	36.5	40.5	05608 →	885
24	19	39.5	43.5	05609 →	885
34	16	46.5	50.5	05610 →	885
34	19	49.5	53.5	05611 →	885

Mushroom dowel

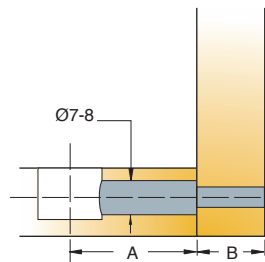
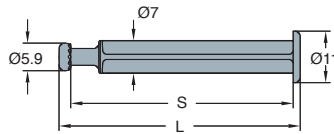

500 Pcs (05610, 05611)
1000 Pcs (05608, 05609)

Made of zinc

Countersunk dowel

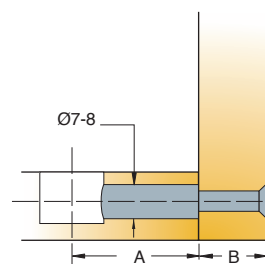
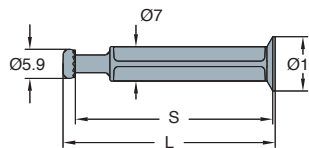

1000 Pcs



Made of zinc

System 5

Cams and Dowels

Ø15mm Cam5000

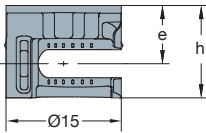
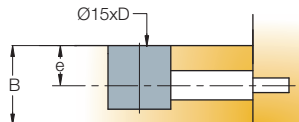
- Improved central shape for highly resistant cam
- Suitable for use with Steel Quickfit TL5 dowels and all other parallel neck dowels
- 'Klix' locking feature provides a strong, vibration proof joint
- Cam retaining pips ensure that cam is held in panel position prior to assembly

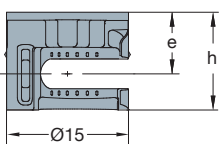
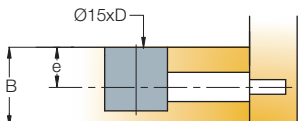
Technical and mounting details		Panel thickness	Drilling depth	Drilling for dowel	Cam height	Item number	Zinc
	 	12/13	10.5	6 min	9.9	09695 →	885
		15/16	12.5	7.5-8	11.9	09690 →	885
	 	15/16	12.5	7.5-8	11.9	09699 →	885
		18/19	14	9-9.5	13.2	09692 →	885
<p>Use standard cover caps with pin=Ø4mm</p> <p>Black available upon request</p>							

1000 Pcs

Made of zinc

1000 Pcs

Made of zinc

System 5

Cams and Dowels

Ø15mm Cam3000

- Its optimised shape provides a more efficient cam profile with smooth tightening action and greater dowel pull-up
- Suitable for use with Combi dowels, forged steel dowels, Quickfit dowels and Quickfit TL dowels
- 'Klix' locking feature provides a strong, vibration proof joint
- Cam-retaining pips ensure that a cam is held in panel position prior to assembly

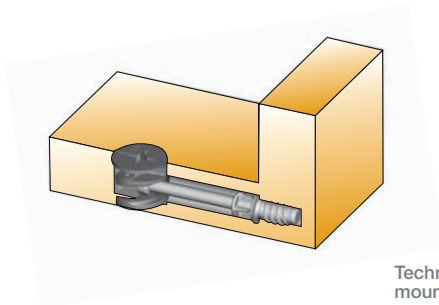

Technical and mounting details

Cam3000 cross drive

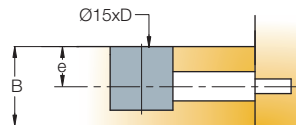
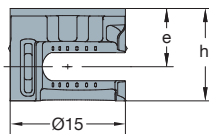

1000 Pcs

Made of zinc

Cam3000 hexagonal drive



combined drive with HEX

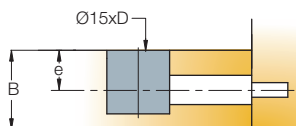
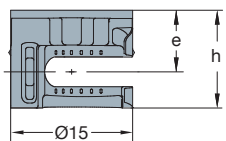

1000 Pcs

Made of zinc

B	D	e	h	Item number	Zinc
Panel thickness	Drilling depth	Drilling for dowel	Cam height		
12/13	10.5	6 min	9.9	09495 →	885
15/16	12.5	7.5-8	11.9	09533 →	885

Black available upon request

15/16	12.5	7.5-8	11.9	09537 →	885
18/19	14	9-9.5	13.2	09536 →	885

Use standard cover caps with pin=Ø4mm







Black available upon request

System 5

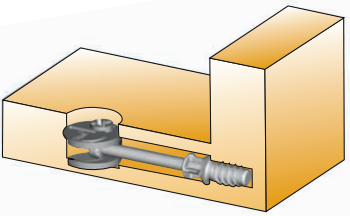
Cams and Dowels

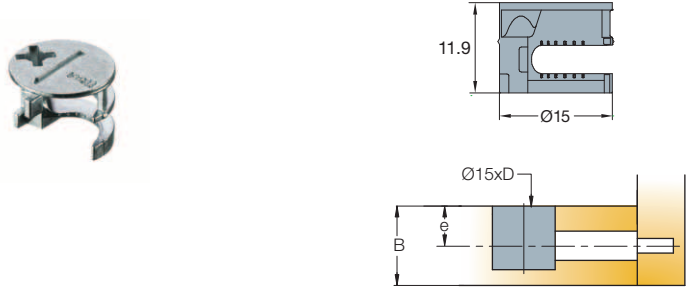
Ø15mm Cam3000 S

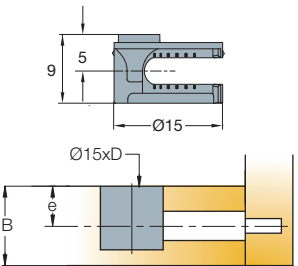
- Innovative design offers optimal performance with maximum cost effectiveness
- Suitable for use with Combi dowels, forged steel dowels and Quickfit dowels
- 'Klix' locking feature provides a strong, vibration proof joint
- Cam-retaining pips ensure that a cam is held in panel position prior to assembly

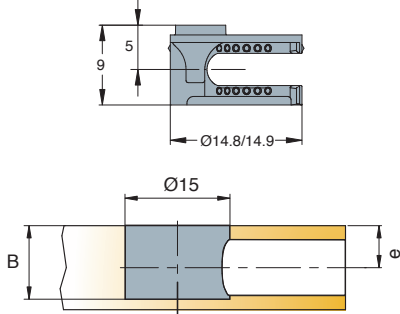
Technical and mounting details		B	D	e	Item number	Zinc	Zinc corrosil
		Panel thickness	Drilling depth	Drilling for dowel			
 <p>Cam3000 S/15</p> <p>PZ2 drive </p>  <p>1000 Pcs Made of zinc</p>	15/16	12.5	7.5-8	09491 →	885	897	
 <p>Cam3000 S/12</p> <p>PZ2 drive </p>  <p>2000 Pcs Made of zinc</p>	12 min	9.5 min	6 min	*09406 →	885	897	
<i>* European market only</i>							
 <p>Cam3000 S/12</p> <p>Philips PH2 drive </p>  <p>1000 Pcs Made of zinc</p>	12 min	9.5 min	6 min	*09631 →	885		
<i>* American market only</i>							



Cover caps 09630
Made of plastic

System 5

Cams and Dowels

Ø15mm Cam2000

- Available in a variety of head, drive recess and board thickness versions to suit most applications
- Suitable for use with all Titus dowels
- 'Klix' locking feature provides a strong, vibration proof joint
- Linear cam profile results in smooth, easy cam rotation and dowel pull-up

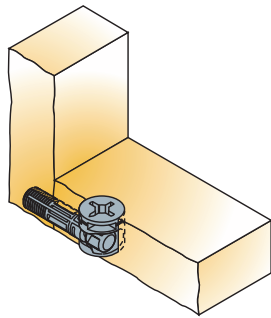

Technical and mounting details

B	D	e	Item number	Nickel	Zinc
Panel thickness	Drilling depth	Drilling for dowel			

Cam2000
Ø15

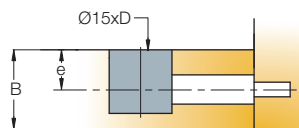
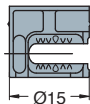

12/13	10min	6-6.5	*05587 →	847	885
12/13	10.9	6-6.5	05653 →	847	885
15/16	12.7	7.5-8	05644 →	847	885
15/16	12.7	7.5-8	05654 →	847	885
18/19	14	9-9.5	05656 →	847	885
22/23	16	11-11.5	05657 →	847	885
25/26	17.9	12.5-13	05676 →	847	885
28/29	19.4	14-15.5	05678 →	847	885

500 Pcs (05676, 05678)
1000 Pcs

Made of zinc

Other finishes on request

***Ultraflat** - specially designed for thin panels
(does not work with TL dowels)

Cam2000
Ø15 headed

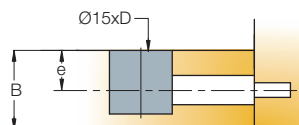
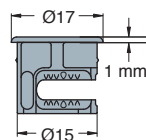

12	10min	6	*05586 →	847	885
13	10.9min	6.5	05652 →	847	885
16	12.9	8	05658 →	847	885
19	13	9.5	05659 →	847	885
23	14.5	11.5	05675 →	847	885
26	16.5	13	05677 →	847	885
29	19.4	14.5	05679 →	847	885

Other finishes on request

***Ultraflat** - specially designed for thin panels
(does not work with TL dowels)

500 Pcs (05675, 05677, 05679)
1000 Pcs

Made of zinc



Cover caps for Ø15 cams
Made of plastic

→ see page 1.63

System 5

Cams and Dowels

Ø12mm Cam2000

- Suitable for all Titus screw-in dowels
- Available in a variety of head, drive recess and board thickness versions to suit most applications
- Particularly suited to drawer front attachment applications
- 'Klix' locking feature provides a strong, vibration proof joint
- Linear cam profile results in smooth, easy cam rotation and dowel pull-up

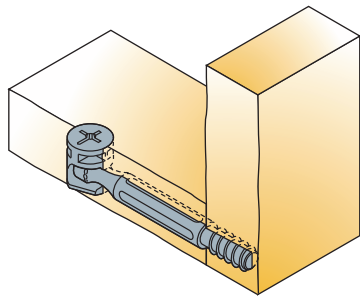

Technical and mounting details

B	D	e	Item number	Black painting plate	Nickel plated	Zinc	Corrosil zinc
Panel thickness	Drilling depth	Drilling for dowel					
12/13	10 min	6-6.5	05575 →	838	847	885	897
15/16	12	7.5-8	05578 →			885	
18/19	13 min	9-9.5	05580 →			885	

Cam2000
Ø12

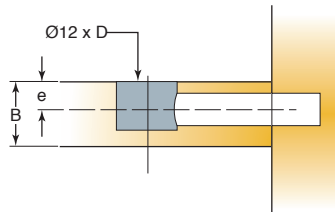
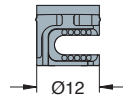

2000 Pcs

Made of zinc

Other finishes on request

Cam2000
Ø12 headed

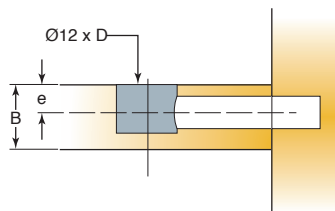
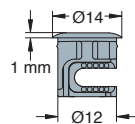

1000 Pcs
2000 Pcs (05576)

Made of zinc

12	9.2 min	5.25	05574 →	838	847	885	897
12	10 min	6	05576 →			885	
16	12.5	8	05579 →			885	

Other finishes on request

Cover caps for Ø12 cams
Made of plastic

→ see page 1.63

System 6 Quickfit-Expando Connectors

System Features

A face boring connector family for 32mm system drilling with full range of panel and application variants for all cabinet manufacturing applications

- Minimum drilling requirements
- Linear cam design for constant tightening loads when driving
- Angledriv feature on cam for maximum driving comfort
- Interchangeable pins for wood, plastic and steel applications
- Pins with twinstart drive for fast insertion
- Interchangeable Quickfit pin fastenings available
- Toolless fastening capable versions
- Back-to-back fastenings for common vertical panel fixing of shelves

System 6 consists of a range of 20mm and 25mm diameter housings, Quickfit™ and conventional dowels, end dowels and double ended dowels.

Housings are made from high grade plastic or zinc, with zinc cams.

Wedgex-6 connector is a special fastener without cam, simply to snap onto a pre-inserted dowel.

Applications

Titus System 6 is ideal for use in high volume production of case goods, closet and garage storage systems. Because no

edge boring is required, it is an excellent choice for manufacturing environments with limited drilling capacity.

Side-entry Drop-on

Side-entry insertion of shelf panel: from the side or from the top

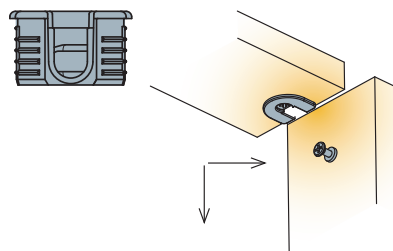

Drop-on insertion of shelf panel: only from the top
Using drop-on connections allows for one-man installation

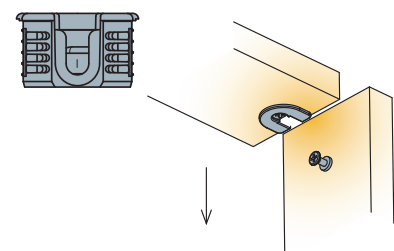

Angledriv feature

The angledriv feature on the cam allows for the angled position of the screwdriver with the locking action creating a tight and secure joint.

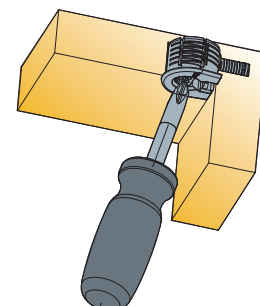

**Outrigger/
Non outrigger**

Outrigger

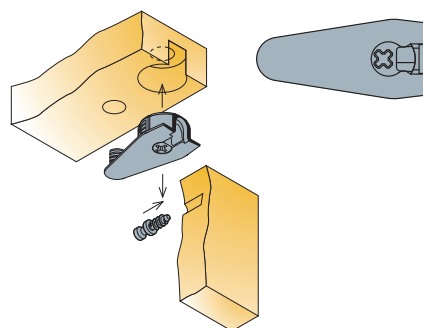

Non outrigger

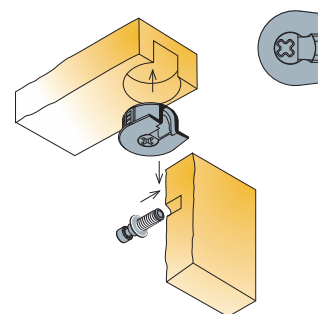

Expando function

Expanding housings and dowels provide a tight joint.

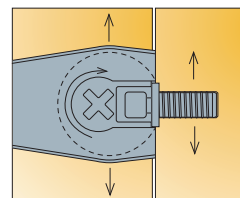
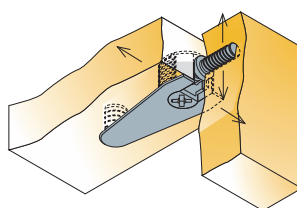

Assembly

1. Press the housing into face board

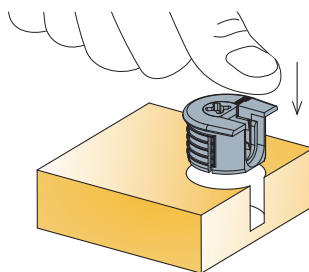

2. Press the dowel into side panel

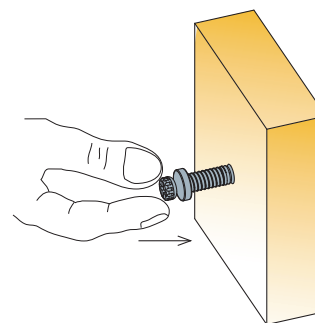

3. Assemble the panels

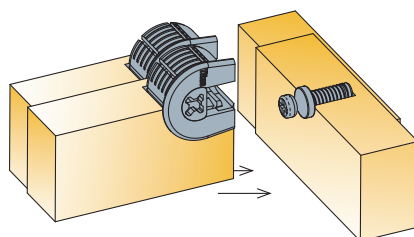

4. Tighten the joint

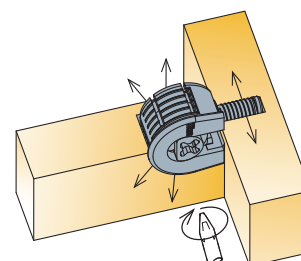





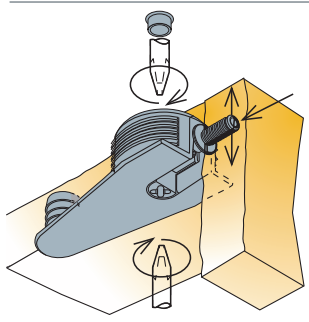

System 6

Quickfit-Expando

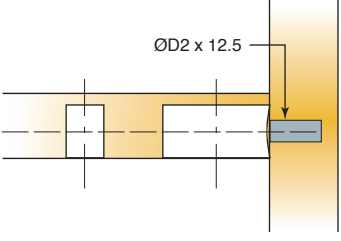
Expanding Dowels

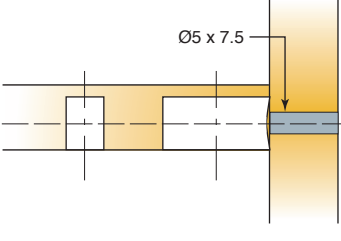
- Available in Ø5mm, Ø8mm and Ø10mm for panel-to-panel, panel-to-hollow profile and back-to-back applications
- Suitable for applications with all Titus Ø20 and/or Ø25mm Expando-6 housings
- 'Klix' locking feature provides a strong, vibration proof connection
- Depth stop collar for accurate insertion

 Technical and mounting details		D2	Item number	Dark grey	Black
		Drilling diameter for dowel thread			
Dowel	 D2= Ø5mm	5	06408 →	880	
		8	06410 →	880	
 D2= Ø8mm	 ØD2 x 12.5				
 5000 Pcs		Made of zinc, plastic			
Dowel Ø5 x 7.5 back-to-back applications			06479 →	880	
 D2= Ø5mm	 Ø5 x 7.5				
 5000 Pcs		Made of zinc, plastic			

System 6 Quickfit-Expando Dowels

- Available in various Ø3mm and/or Ø5mm thread forms for screw-in, knock-in and/or 'spiked' hole applications
- Suitable for applications with all Titus Ø20mm and/or Ø25mm Expando-6 housings
- 'Klix' locking feature provides a strong, vibration proof connection
- Dowels feature an integral skirt which acts as a positive stop during insertion

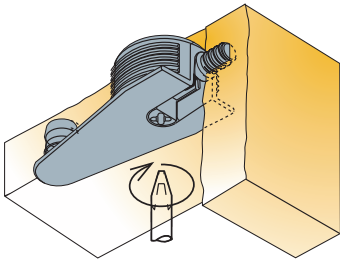

Technical and mounting details

C	Drilling depth for dowel thread	Item number	Finish	
			Zinc	Zinc plated
	9	06401 →	885	
	8	06402 →	885	883
	11.5	06406 →	885	883
		06403 →	885	
		06405 →		883
		06495 →		883

Dowel Ø5

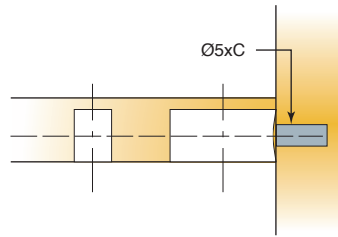

2000 Pcs

Made of zinc or steel

Dowel Ø5 x 11 knock-in

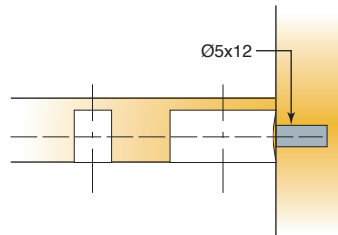

2000 Pcs

Made of zinc

Dowel M4 x 7

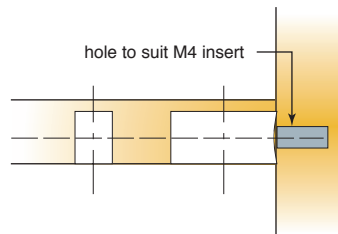

4500 Pcs

Made of steel

Dowel Ø3 x 11.5

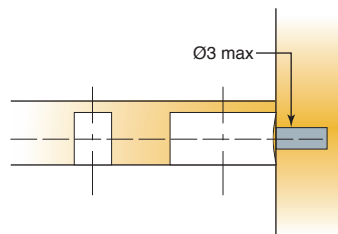

12500 Pcs

Made of steel

Inserts
Made of plastic

→ see page 1.62

System 6

Quickfit-Expando

Double-ended Dowels

- For 16mm, 18mm and 19mm board
- Suitable for applications with all Titus Ø20mm and/or Ø25mm Expando-6 housings
- 'Klix' locking feature provides a strong, vibration proof connection

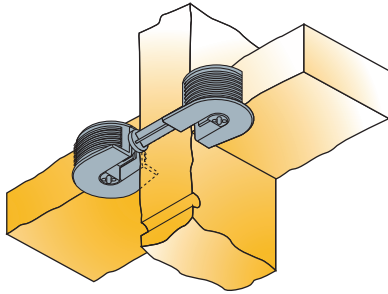

Technical and mounting details

Double-ended dowel

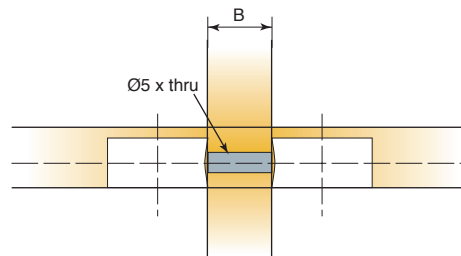
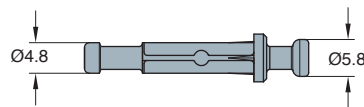

B	Item number	Zinc
Panel thickness		
16	06414 →	885
18	06413 →	885
19	06416 →	885



2500 Pcs

Made of zinc

System 6 Quickfit-Expando End Dowels

- For 16mm, 18mm and 19mm board
- Suitable for applications with all Titus Ø20mm and/or Ø25mm Expando-6 housings
- 'Klix' locking feature provides a strong, vibration proof connection

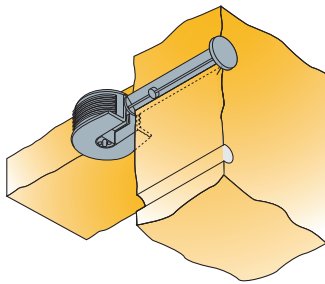

Technical and mounting details

End dowel

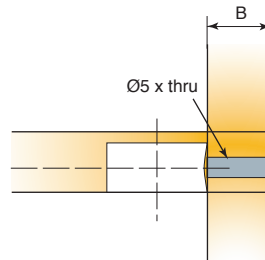
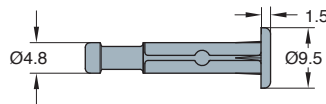

Panel thickness	Item number	Zinc
16	06412 →	885
18	06411 →	885
19	06415 →	885

2500 Pcs
1000 PCS (06411)

Made of zinc







System 6

Quickfit-Expando

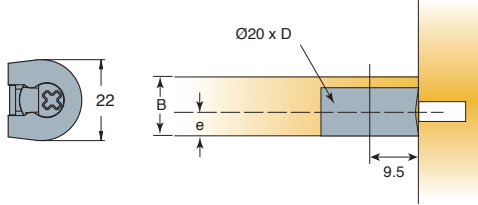
20mm Expanding Housing

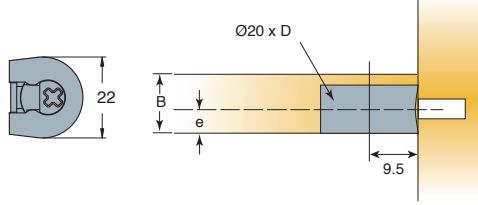
Non-outrigger

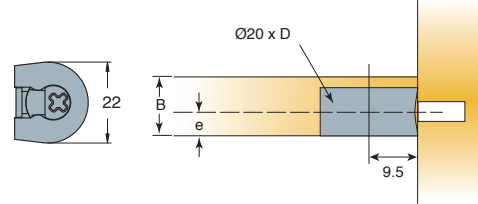
- Available in 15mm/16mm and 18mm/19mm versions for drop-on and/or side-entry applications
- Available in all-metal or plastic/metal options
- 'Klix' locking feature provides a strong vibration proof connection
- Compatible with all screw-in and Quickfit-6 dowels

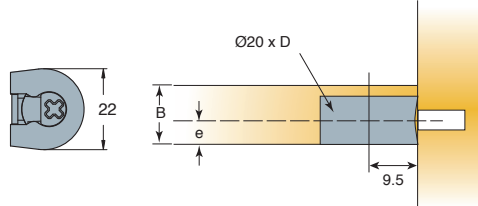
Technical and mounting details				e	B	D	Item number	Dark brown plastic	Nickel plated	Silver plastic	White plastic
					Panel thickness	Drilling depth					
Side-entry  500 Pcs Made of zinc		7.75	15/16	12.5	06451 →		847				
		9.25	18/19	14	06453 →		847				
Side-entry  2500 Pcs Made of plastic		7.75	15/16	12.5	06435 →	831		861	877		
		9.25	18/19	14	06437 →	831		861	877		
<i>Other colours on request</i>											
Drop-on  500 Pcs Made of zinc		7.75	15/16	12.5	06447 →		847				
		9.25	18/19	14	06449 →		847				
Drop-on  2500 Pcs Made of plastic		7.75	15/16	12.5	06431 →	831		861	877		
		9.25	18/19	14	06433 →	831		861	877		
<i>Other colours on request</i>											

System 6

Quickfit-Expando

20mm Expanding Housing

Outrigger

- Available in 15mm/16mm and 18mm/19mm versions for drop-on and/or side-entry applications
- Available in all-metal or plastic/metal options
- 'Klix' locking feature provides a strong vibration proof connection
- Compatible with all screw-in and Quickfit-6 dowels

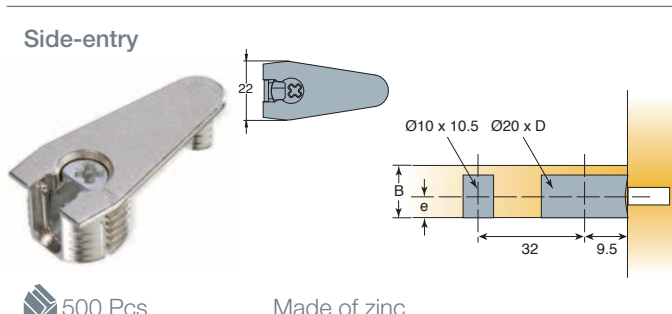
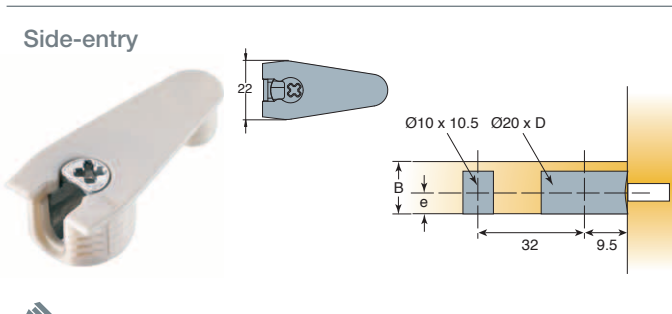
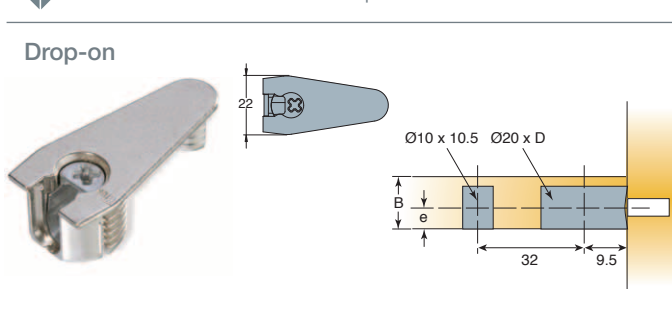
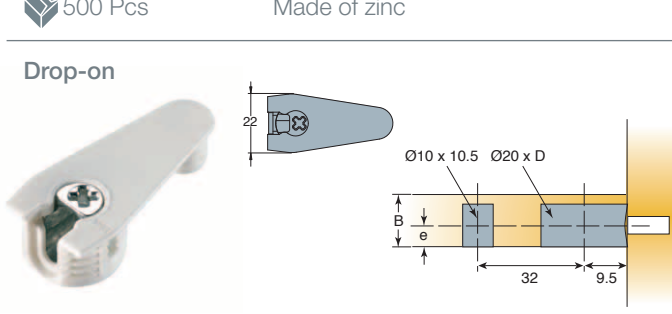
Technical and mounting details		e	B	D	Item number	Dark brown plastic	Black plastic	Nickel plated	White plastic
Side-entry  <p>500 Pcs Made of zinc</p>	7.75	15/16	12.5	06459 →				847	
	9.25	18/19	14	06461 →				847	
Side-entry  <p>1250 Pcs Made of plastic</p>	7.75	15/16	12.5	06443 →				877	
	9.25	18/19	14	06445 →		831	835	877	
	9.25	18/19	14	*06395 →			835	877	
<i>Other colours on request *American market only</i>									
Drop-on  <p>500 Pcs Made of zinc</p>	7.75	15/16	12.5	06455 →				847	
	9.25	18/19	14	06457 →				847	
Drop-on  <p>1250 Pcs Made of plastic</p>	7.75	15/16	12.5	06439 →			835	877	
	9.25	18/19	14	06441 →		831	835	877	
	9.25	18/19	14	*06397 →			835	877	
<i>Other colours on request *American market only</i>									

System 6

Quickfit-Expando

Expanding Wedgefix Housing (no Inner Cam)

- Available in 12mm, 15mm/16mm and/or 18mm/19mm versions for Quickfit-6 and/or Standard Dowel applications
- Available in a variety of plastic colours
- Wedgefix-6 housing allows easy customer hand-assembly or factory automated insertion
- When used with Quickfit-6 dowels this provides a true toolless fastening system

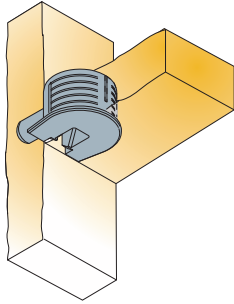

Technical and mounting details

For use with screw-in dowels

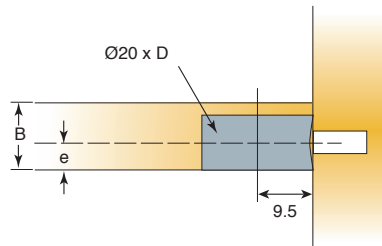
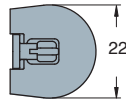

2500 Pcs

Made of plastic

For use with Quickfit dowels

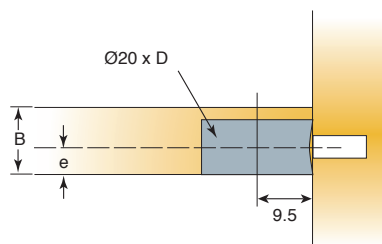
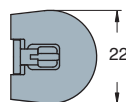

2500 Pcs

Made of plastic

e	B	D	Item number	White	Black	Dark brown	Silver
6	12	10	06470 →	877			861
7.75	15/16	12.5	06473 →	877	835	831	861
9.25	18/19	14	06465 →	877	835	831	861
11	22	16	06464 →				861
<i>Other colours on request</i>							
7.75	15/16	12.5	06471 →	877	835	831	861
9.25	18/19	14	06472 →	877	835	831	861
<i>Other colours on request</i>							

System 6

20mm Knock-in Housing

Non-outrigger

- Available in 15mm/16mm and 18mm/19mm versions for drop-on and/or side-entry applications
- Available in all-metal or plastic/metal options
- 'Klix' locking feature provides a strong vibration proof connection
- Compatible with all screw-in and Quickfit-6 dowels

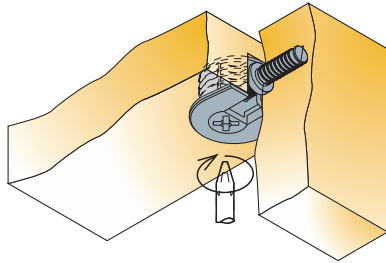

Technical and mounting details

Side-entry

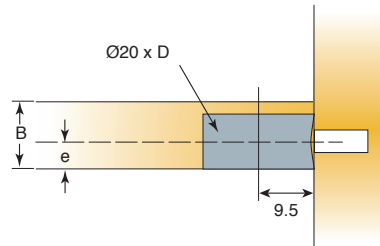
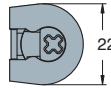

2500 Pcs

Made of plastic

Drop-on

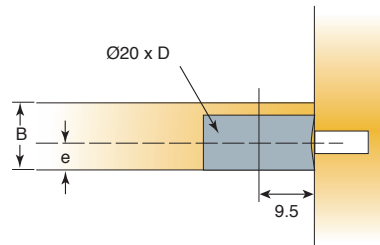
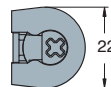

2500 Pcs

Made of plastic



Cover cap 06463
Made of plastic

e	B	D	Item number	Silver plastic	White plastic
7.75	15/16	12.5	06381 →	861	877
9.25	18/19	14	06385 →	861	877
<i>Product available on American and Asian market only</i>					
<i>Other colours on request</i>					

7.75	15/16	12.5	06383 →	861	877
9.25	18/19	14	06387 →	861	877
<i>Product available on American and Asian market only</i>					
<i>Other colours on request</i>					

System 6

Quickfit-Expando

25mm Heavy Duty Expanding Housing Non-outrigger

- Suitable for 12mm, 15mm/16mm and 18mm/19mm board for drop-on and/or side-entry applications
- All-metal
- 'Klix' locking feature provides a strong vibration proof connection
- Compatible with all System 6 Quickfit dowels

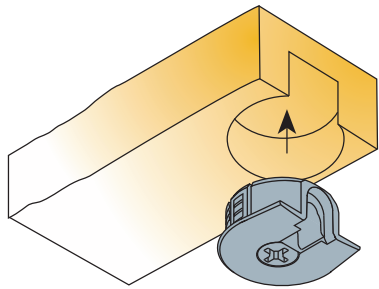

Technical and mounting details

Side-entry

D	e	Item number	Nickel plated
Drilling depth	Drilling for dowel		
11	5	06953 →	847

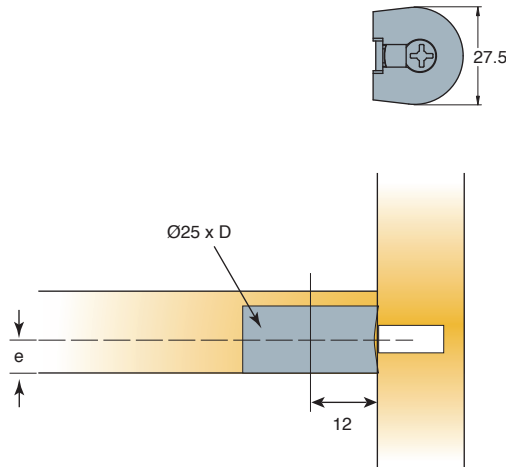

500 Pcs

Made of zinc

Drop-on

11	5	06949 →	847
----	---	---------	-----

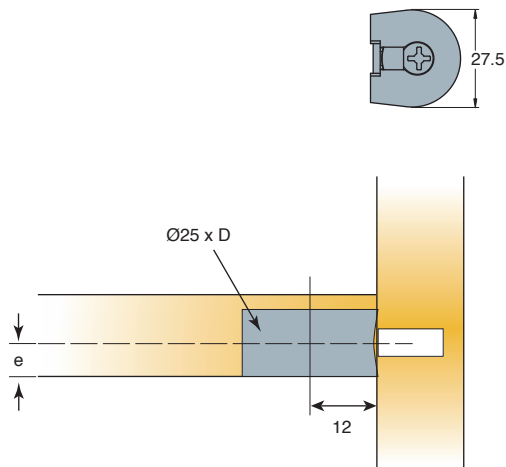

500 Pcs

Made of zinc

Dowels → see page 1.47

System 6 Quickfit-Expando 25mm Heavy Duty Expanding Housing Outrigger

- Suitable for 12mm, 15mm/16mm and 18mm/19mm board for drop-on and/or side-entry applications
- Available in all-metal
- 'Klix' locking feature provides a strong vibration proof connection
- Compatible with all System 6 Quickfit dowels

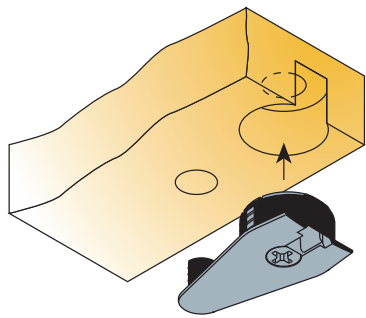

Technical and mounting details

D	e	Item number	Nickel plated
Drilling depth	Drilling for dowel		

Side-entry

11	5	06951 →	847
----	---	---------	-----

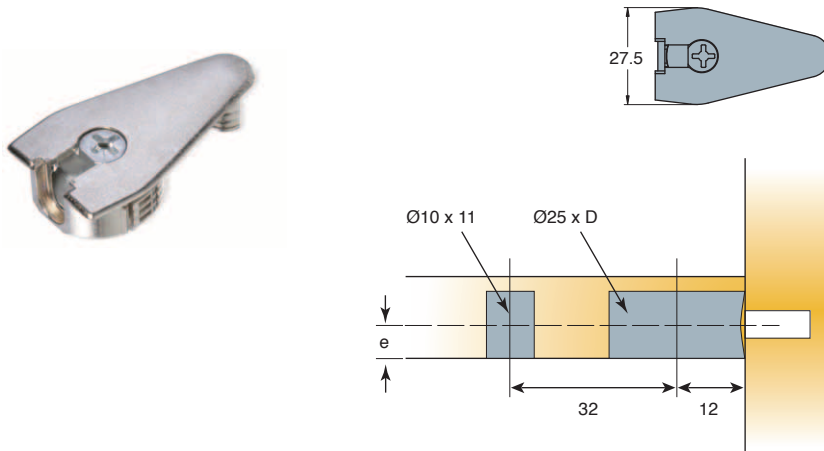

400 Pcs

Made of zinc

Drop-on

11	5	06947 →	847
----	---	---------	-----

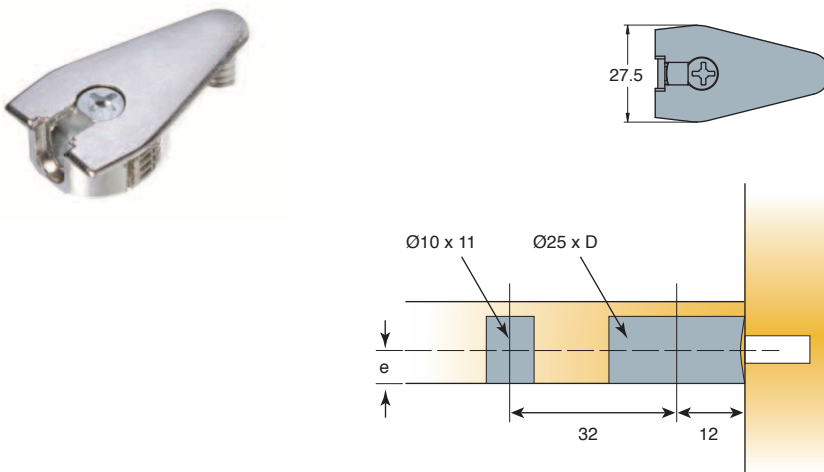

500 Pcs





Made of zinc

Dowels → see page 1.47

System 7

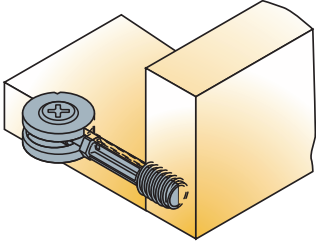
Heavy Duty Ø20mm Cam and Dowel

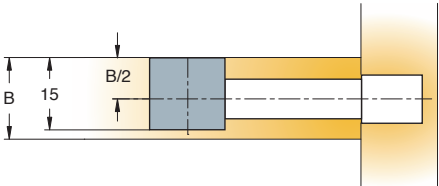
- Dowel available with Ø10mm eurothread and cam available in Ø20mm for a variety of panel thicknesses
- 'Klix' locking feature provides strong, vibration proof joint
- High strength product that eliminates the need for time consuming metal inserts

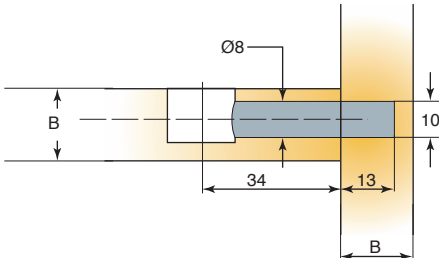
 <p>Technical and mounting details</p>	B		 Zinc
Cam Ø20	Panel thickness	Item number	Zinc
  <p>500 Pcs Made of zinc</p>	18	05409 →	885
  <p>500 Pcs Made of zinc</p>	18 min	05410 →	885

System 7



Heavy Duty Ø25mm

Cam and Dowel

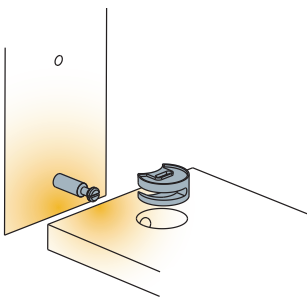
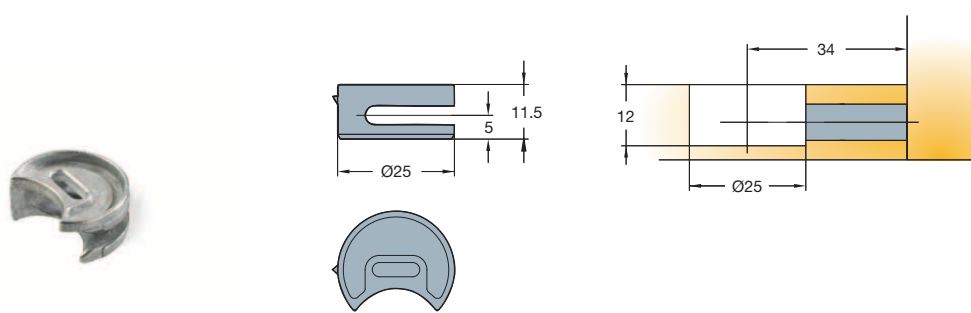
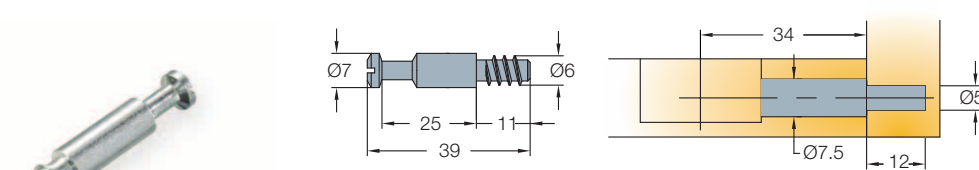
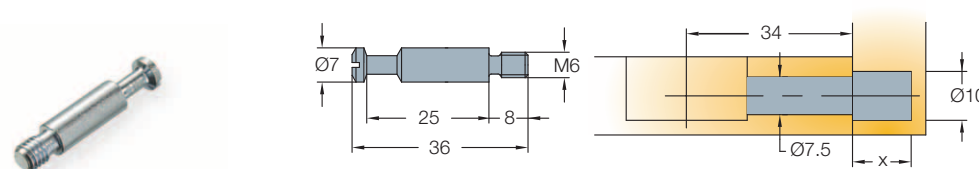

Cam not compatible with other dowels

- For 13mm and thicker panels
- Cam drilling distance is 34mm
- A flat slot screwdriver must be used for cam tightening
- Decorative cover caps are available in different colours
- Dowel for direct installation in 5mm holes

 <p>Technical and mounting details</p>	Item number	Raw	Zinc plated blue
<p>Cam</p>  <p>1000 Pcs Made of zinc</p>	275-3096 →	600	
<p>Dowel with euro thread</p>  <p>1000 Pcs Made of steel</p>	275-2209 →		040
<p>M6 dowel</p>  <p>1000 Pcs Made of steel</p> <p>  275-4058 x=11  275-4035 x=13 </p>	275-2030 →		040

 **Cover cap**
Made of plastic

→ see page 1.63

 **Inserts**
Made of plastic







→ see page 1.62

System 7

Heavy Duty Dowels

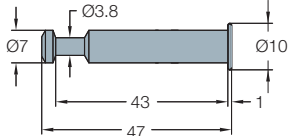
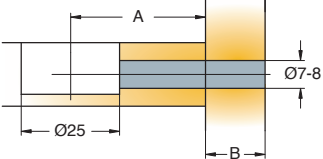

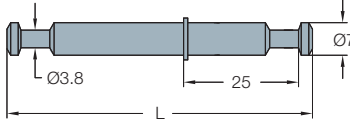
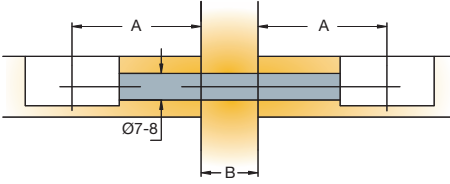
Heavy duty only. Can't be used with other cams.

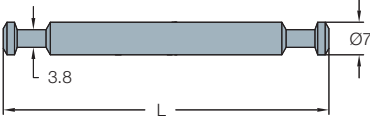
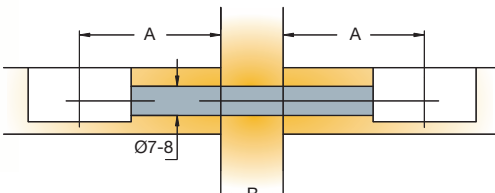





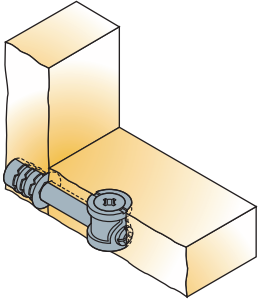

<p>Technical and mounting details</p>	L	A	B	Item number	 Zinc plated blue	 Brass plated black
<p>End dowel</p>    <p>500 Pcs Made of steel</p>		52-B		275-2146 →	040	*085
<p>* Available upon special request → see chapter Important Information</p>						
<p>Dowel with circlip</p>    <p>500 Pcs Made of steel</p>	76	34	20	275-0103 →	040	
<p>Dowel without circlip</p>    <p>500 Pcs Made of steel</p>	74	34	20	275-2057 →	040	
	76	34	18	275-2058 →	040	

System 7

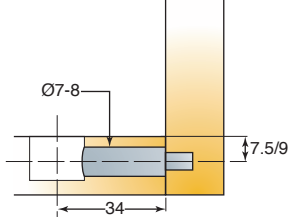
High Strength Connectors

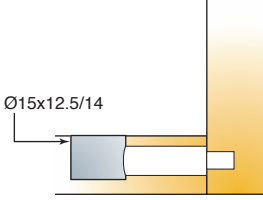

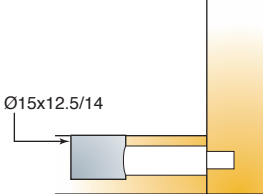



Contract Fix™ System

- High performance fastener
- Thread design gives repeatability
- Multi-drive recess
- Higher than average pull up

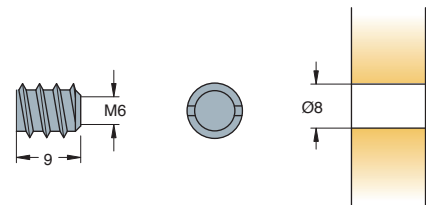
 <p>Technical and mounting details</p>	Item number	Zinc plated	Zinc
<p>M6 Dowel 7x34</p>   <p>1000 Pcs Made of steel</p>	05971 →	883	
<p>Housing cylinder 15x12</p>   <p>1000 Pcs Made of zinc</p>	05960 →		885
<p>Grub screw</p>   <p>2500 Pcs Made of zinc</p>	05917 →		885
 <p>Inserts Made of zinc</p> <p>→ see page 1.61</p>			

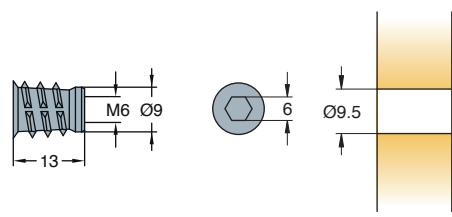

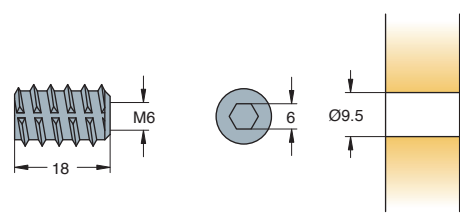

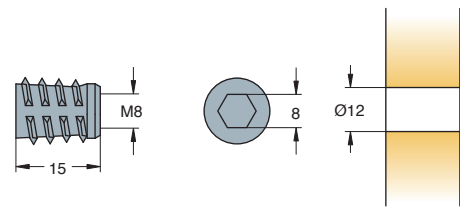

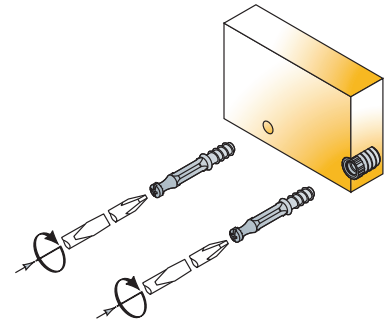

Accessories for Connectors

Inserts

		Technical and mounting details	Item number	Raw
<p>Ø8 x 9</p>  <p>100 Pcs Made of zinc</p>		<p>408-3166 →</p>	<p>600</p>	
<p>Ø9 x 13</p>  <p>1000 Pcs Made of zinc</p>		<p>408-3391 →</p>	<p>600</p>	
<p>Ø9.5 x 18</p>  <p>1000 Pcs Made of zinc</p>		<p>408-3423 →</p>	<p>600</p>	
<p>Ø12 x 15</p>  <p>1000 Pcs Made of zinc</p>		<p>408-3424 →</p>	<p>600</p>	

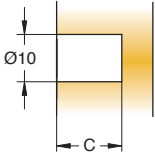
- Available in both zinc and plastic for use in various applications
- Suitable for use with various threaded dowels
- Suitable for use with various panel thicknesses
- Knock-in and screw-in versions available

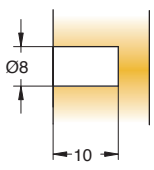







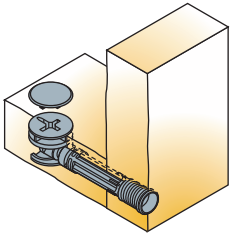

Technical and mounting details		C			
		Drilling length for insert	Item number	Natural white	Natural
Ø10 x 13/M6 nut  20000 Pcs (275-4035)  30000 Pcs (275-4058)	M6  275-4035 M6  275-4058		13	275-4035 →	200
			11	275-4058 →	200
Ø8 x 10/M4 nut  50000 Pcs	M4 			276-4036 →	200
Euro thread  10000 Pcs	Euro thread 5 			02182 →	846

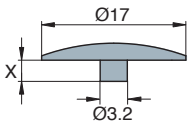
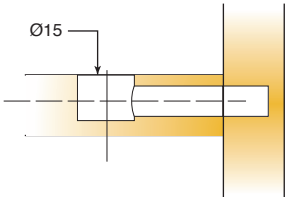
Accessories for Connectors

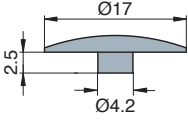
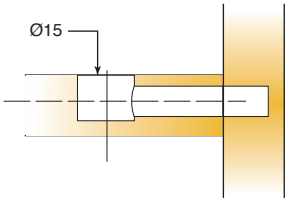
Cover Caps

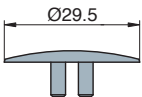
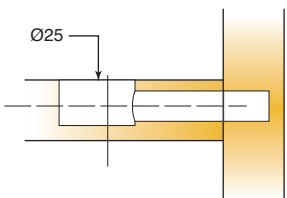
- Available in a variety of colours
- Suitable for use with both pozi and hex cam drive features
- Suitable for use with various diameter cams
- Both domed and flat versions available

 Technical and mounting details		X					
			Item number	Dark brown	Black	Light brown	Light grey
Cover cap Ø17  		3.3	*01029 →	834	835	867	882
		2.5	277-4355 →	370	390	330	380
 1000 Pcs Made of plastic		<i>*American market only Other colours on request</i> <i>Suitable for cams with Pozi 2 recess</i>					
Cover cap Ø17  			277-4225 →	370	390	330	380
		<i>Other colours on request</i> <i>Suitable for cams with Hex recess</i>					
 1000 Pcs Made of plastic							
Cover cap Ø29.5  			275-4034 →	370	390	330	380
		<i>Other colours on request</i>					
 500 Pcs Made of plastic							

Glissando Soft Closing Systems

Glissando for Concealed Hinges

Add-on hinge soft closing solution

2.15

Glissando TL
Glissando TL 170

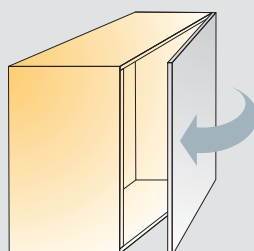

- effortless silent and safe door closing
- fits the hinge's standard drilling patterns
- easy retrofit installation
- adjustable to different door sizes and weights
- perfect door motion
- doesn't occupy additional space inside the cabinet

Stand-alone door soft closing solution

2.17

Glissando CR

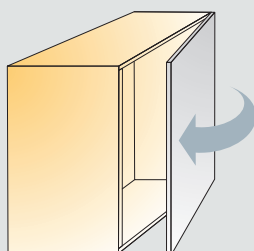

- effortless silent and safe door closing
- easy retrofit installation
- adjustable to different door sizes and weights
- perfect door motion

Titusoft for Drawers

Stand-alone drawer soft closing solution

2.19

Titusoft for wooden drawers
Titusoft for metal drawers

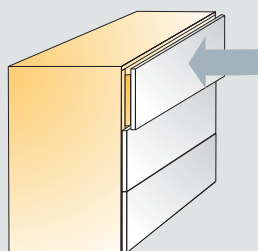

- self closing and soft closing in single mechanism
- safe drawer closing
- easy retrofit installation

Titusoft for Sliding Doors

Stand-alone sliding door soft closing solution

2.27

Titusoft SD100

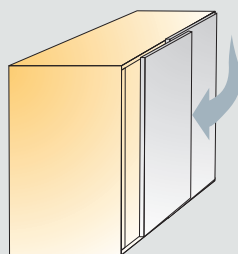

- effortless silent and safe door closing
- intuitive mounting
- efficient damping
- smooth and controlled closing motion

Glissando

Soft Closing Range

How to Choose the Right Glissando?

Glissando TL
Glissando TL 170
Glissando CR

Titus Glissando soft closing system is available for the whole range of hinge applications. The user can choose between add-on hinge or stand-alone solutions.

Concealed hinges	Add-on hinge soft closing solutions		Stand-alone door soft closing solution
	Glissando TL	Glissando TL 170	Glissando CR
T-type 110	X		X
T-type 110/45°	X		
T-type 110/90°	X		
T-type 120			X
T-type 170		X	
S-type plus 110	X		X
S-type 110	X		X
S-type 110/15°	X		
S-type 110/24°	X		
S-type 110/30°	X		
S-type 110/45°	X		
S-type 110/90°	X		
S-type 170		X	X
B-type 110	X		X
B-type 110/30°	X		
B-type 110/45°	X		
B-type 110/90°	X		
B-type 170		X	X
Hinge Ø40			X

Glissando

Application

Glissando TL 'one for all'

T-type

- One item fits multiple applications
- Same item can be used on all crankings and angled hinges
- Adjustable damping enables perfect functioning on every door
- Designed to fit the concealed hinge cup
- Toolless mounting
- Suitable for different types of cabinets for kitchens, living rooms, bathrooms and other furniture

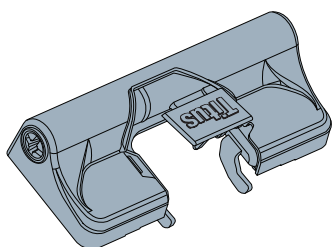

T-type 110
0mm



T-type 110
5mm



T-type 110
9mm



T-type 110
17mm



T-type 110/45°
17mm



T-type 110/90°
17mm



Glissando

Application

Glissando TL 'one for all'

S-type B-type

- One item fits multiple applications
- Same item can be used on all crankings and angled hinges
- Adjustable damping enables perfect functioning on every door
- Designed to fit the concealed hinge cup
- Toolless mounting
- Suitable for different types of cabinets for kitchens, living rooms, bathrooms and other furniture

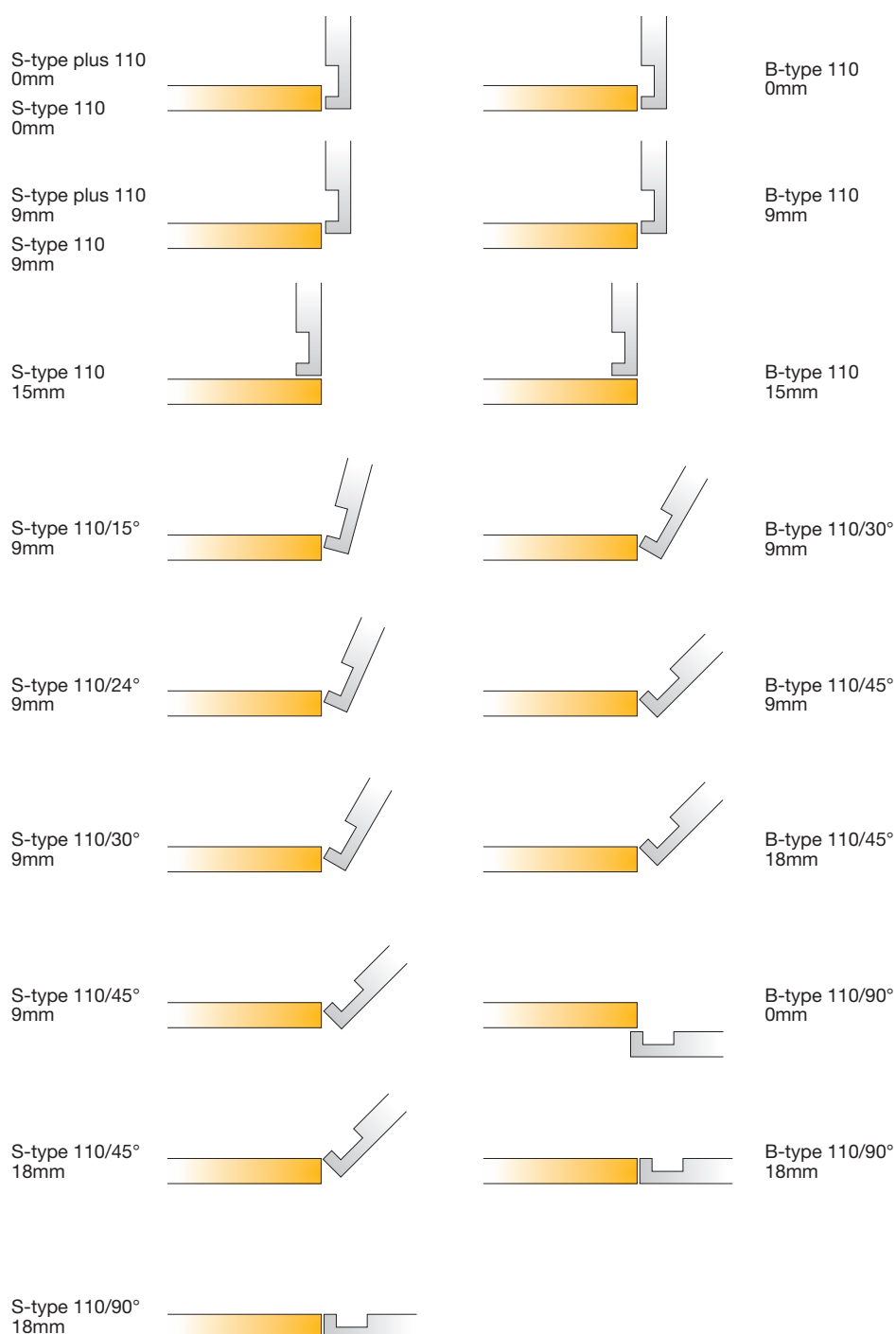
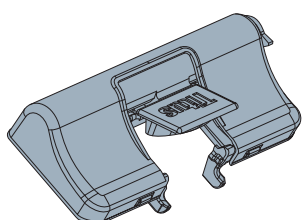

Glissando

Number per Door and Positioning



Titus Glissando soft closing devices can not be used with free-swinging door hinges.
 → see page 3.24 for details

How Many Glissandos per Door?

Add-on hinge soft closing solution

Glissando TL
 Glissando TL 170

Mount Glissando on the bottom hinge in case of 2 hinges on the door or on the middle hinge in case of 3 hinges on the door.

T-type

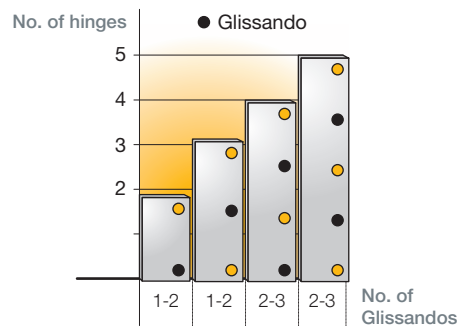

Recommended number per door and positioning

S-type, B-type

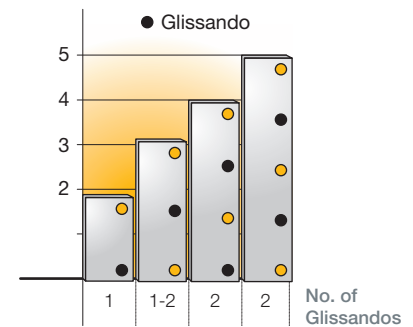

Recommended number per door and positioning

Stand-alone soft closing solution

Glissando CR

Mount Glissando CR on the hinged side of the cabinet on the top or bottom.

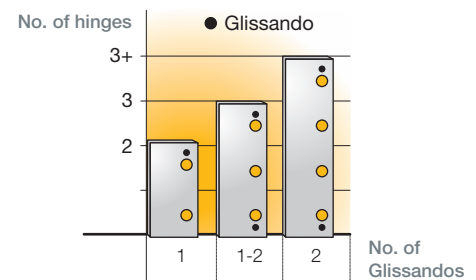

Recommended number per door and positioning

Glissando Mounting

How to Mount Glissando?

Tool-less mounting

Glissando TL
Glissando TL 170

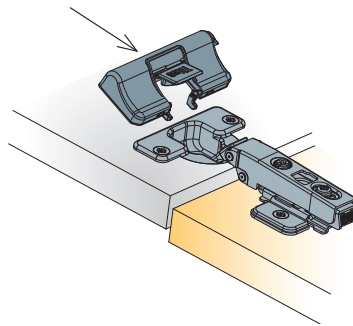

Simple toolless assembly: Insert Glissando into the holes on the hinge and press down with hand.

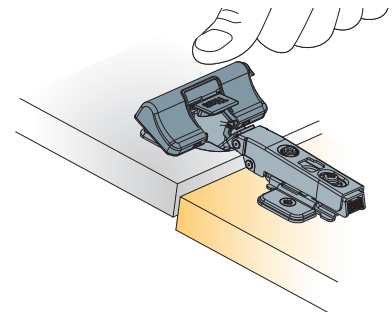

The tool-less 'snap on' version for reduced assembly time and flexibility of application. Glissando TL can be mounted at any time after furniture assembly so can be offered as a retro fit option by the installer.

Screw-on into the cabinet corner

Glissando CR

Glissando CR is mounted into the cabinet corner by using chipboard screws 20mm long.

Glissando dampers' discreet design enhances the look of the door and occupies minimal space in the cabinet interior.

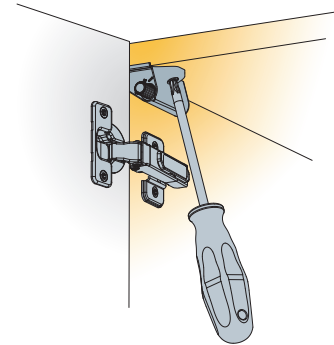

Glissando

Damping Adjustment

How to Adjust Damping?

Add-on hinge soft closing solution

Glissando TL
Glissando TL 170

Glissando features quarter turn adjustment to provide optimal closing speed for any door dimensions and weight.

The damping function can be adjusted to fit different door weights which enables

- perfect door functioning
- use of the same type of Glissando for various doors

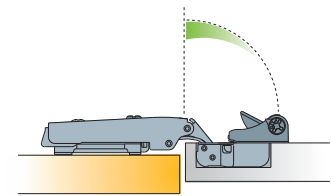

Adjustable damping zone

S-type, B-type

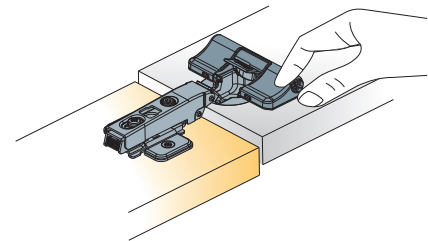

Turn towards '+' to increase and '-' to decrease the damping

Stand-alone soft closing solution

Glissando CR

Turn towards '+' to increase or towards '-' to decrease the damping.

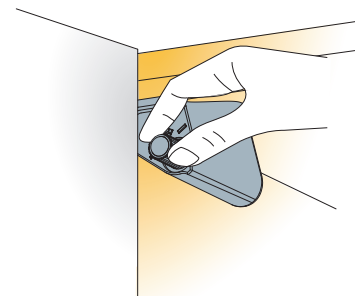

Titus Hydraulic Damper

Efficient modular design

- Low number of assembly parts enables quick development of customised solutions
- Engineered for efficient and high precision manufacturing
- Wide range of applications



Wide operating scope

- High coefficient γ of Titus damper assures efficient damping at any closing speed
- Damping force can be easily adapted to customer needs

$$\gamma = \frac{F_H}{F_L}$$

F_H – damping force at slam speed (12mm/s)
 F_L – damping force at slow speed (1mm/s)

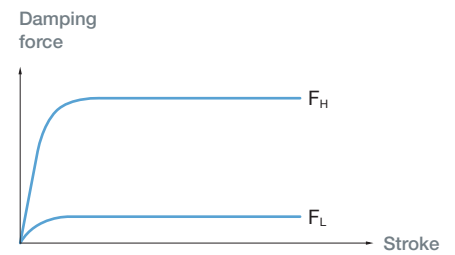

Reliable damping and closing at any speed

Higher coefficient γ means reliable damping at high speed and ensures that the system will reach its final position even at very slow speed



Glissando Soft Closing Systems for Hinges

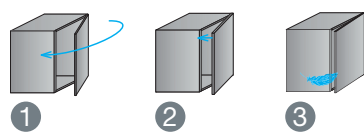

'ConfidentClose'

- 1 Fast closing
- 2 Late start of deceleration action
- 3 Quiet landing with 'SoftTouch'

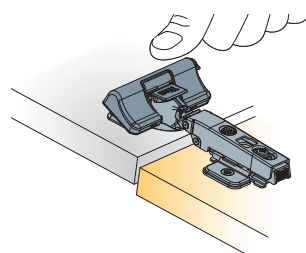

Tool-less mounting

- Reduced assembly time
- Flexible usage als as a retrofit option

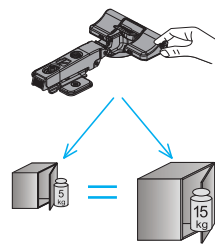

Adjustable damping

- Consistent performance accross a broad range of furniture doors of different dimensions and weights



Easy tool-less adjustment

- Intuitive adjustment procedure
- Controlable motion

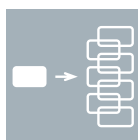

'One for all'

- One item fits multiple applications
- Same item can be used on all crankings and angled hinges



'Titus Damper Inside'

- Titus proprietary multi-purpose damping technology
- Reliable and consistent damping

Glissando TL

Add-on Hinge Soft Closing Solution

For 110° hinges

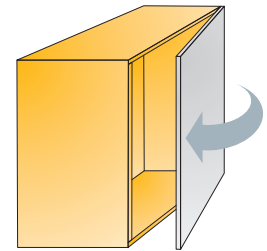
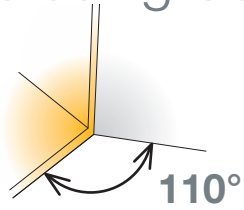

Technical details		Hinge opening angle	Damping force	Interaxis 45mm	Interaxis 48mm
				Item number	Item number
<p>Glissando TL 'snap-on'</p> <ul style="list-style-type: none"> · T-type 110 <p>200 Pcs Made of steel and plastic</p>		110°		729-0K71-054	
<p>Glissando TL 'snap-on'</p> <ul style="list-style-type: none"> · S-type plus 110 · S-type 110 · B-type 110 <p>200 Pcs Made of steel and plastic</p>		110°	■ 45N	951-0X94-050	
		110°	■ 35N	951-0P59-050	
		110°	■ 60N	951-0P63-050	

- Same item can be used on all crankings and angled hinges
- Designed to fit the concealed hinge cup and requires no extra space inside the cabinet
- Adjustable damping
- Toolless mounting

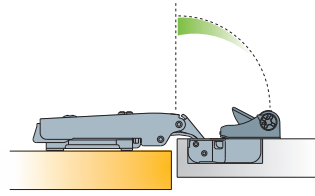

Adjustable damping zone

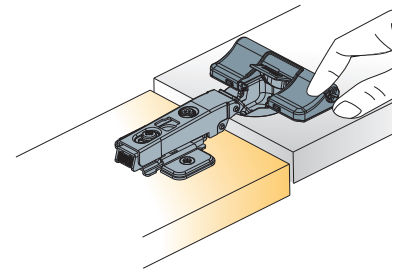

Turn towards '+' to increase and '-' to decrease the damping

Mounting details

Toolless assembly

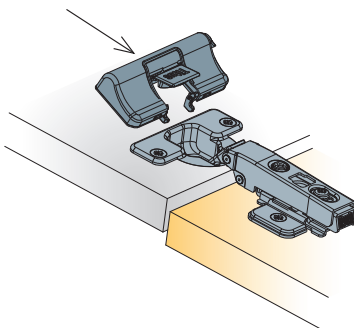

Insert Glissando TL into the holes on the hinge

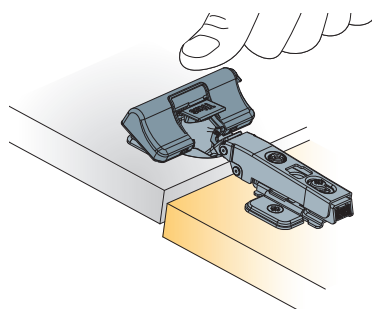

Press down

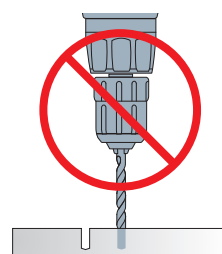
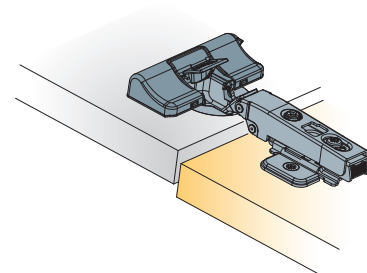

No additional drilling is required

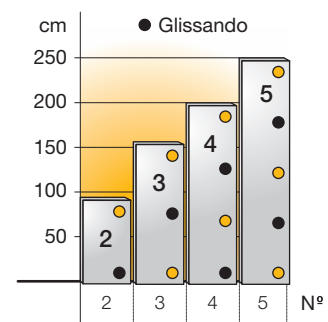

Recommended number per door and positioning

Glissando TL 170

Add-on Hinge Soft Closing Solution

For T-type 170, S-type 170 and B-type 170

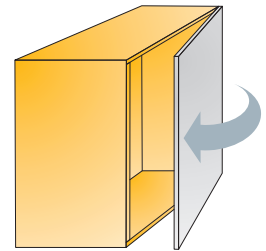

Technical details

Hinge opening angle

Item number

Glissando TL 170 'snap-on'

170°

951-0F15-650



Soft closing mechanism

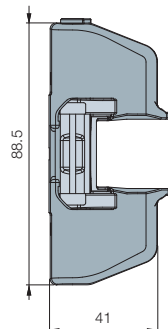

Box content
100 pcs soft closing mechanisms
100 pcs striking plates



Striking plate

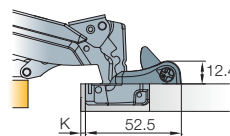

Made of steel and plastic

- Gentle and reliable soft closing on doors with wider opening angle
- Fits perfectly 45/9.5mm, 48/6mm and 52/5.5mm hinge cups
- Furniture consumers' preferred 'ConfidentClose'
- Tool free mounting

Damping adjustment

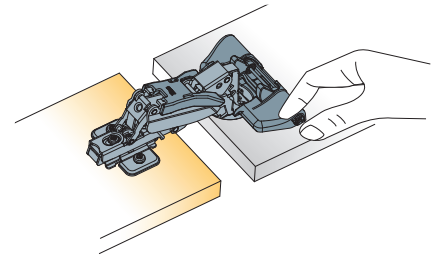

Turn towards '+' to increase and '-' to decrease the damping

Mounting details

Toolless mounting

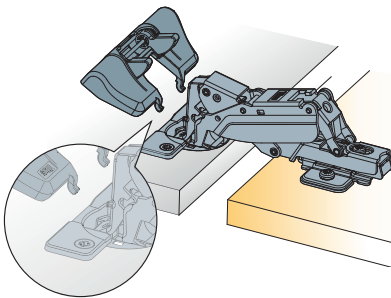

Insert Glissando TL 170 into the holes on the hinge cup

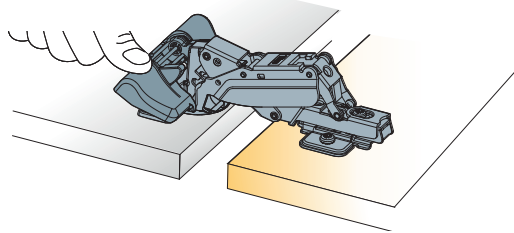

Press down

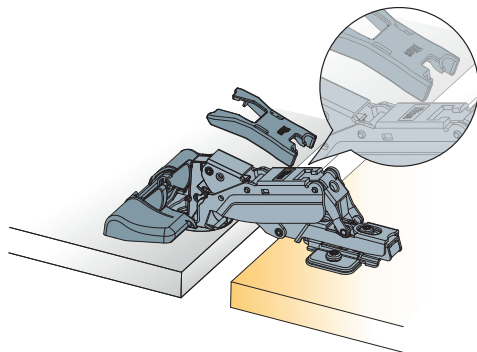

Place the striking plate into the hole on the hinge arm

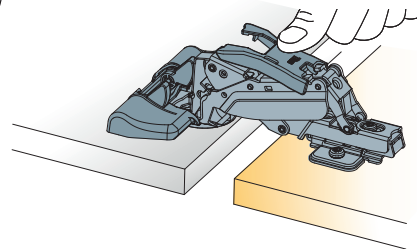

Press down

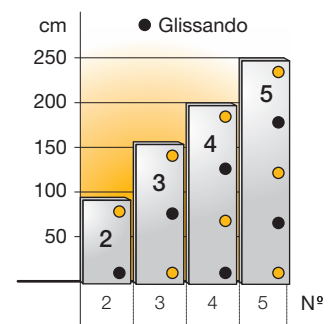
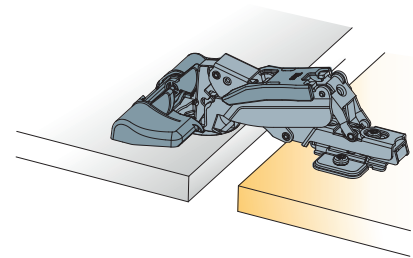

Recommended number per door and positioning

Glissando CR

Stand-alone Door Soft Closing System

For full overaly and half overaly concealed hinges

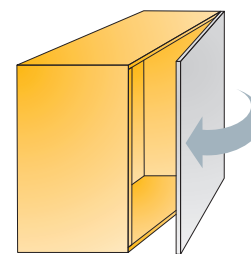

Technical details	Hinge opening angle	Cranking	Item number	White	Grey	Beige
-------------------	---------------------	----------	-------------	-------	------	-------

Glissando CR for full overlay hinges



Nominal 11
(Adjustment: Nominal + 5mm)

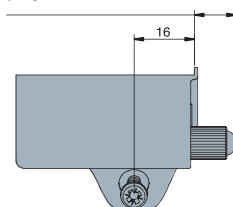

110°	0mm	972-0X19 →	350	380	360
------	-----	------------	-----	-----	-----

*Fixing screw included in a set

100 Pcs Made of plastic

Glissando CR for half overlay hinges



Nominal 10
(Adjustment: Nominal + 5mm)

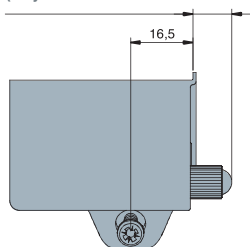

110°	9mm	972-0X34 →		380	
------	-----	------------	--	-----	--

- Intuitive 'place and fix' installation in the corner of the cabinet
- Tool-less damping adjustment
- One item for a wide range of doors
- Reliable performance

Damping adjustment

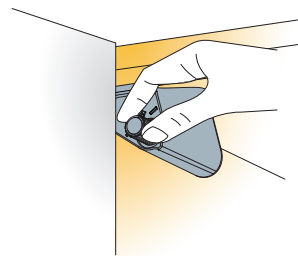

Turn towards '+' to increase and towards '-' to decrease the damping

Mounting details

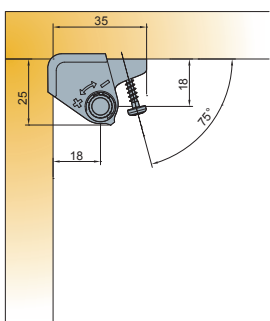

Further explanations → go to http://www.youtube.com/watch?v=8-uWs_z2d0s

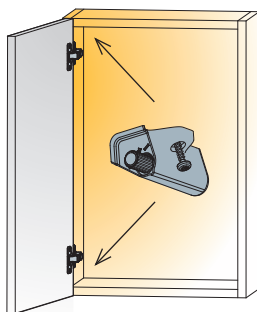

Mount Glissando CR on the hinged side of the cabinet

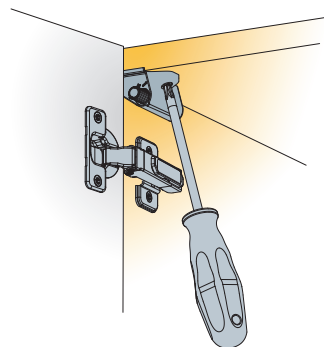

One screw fixing

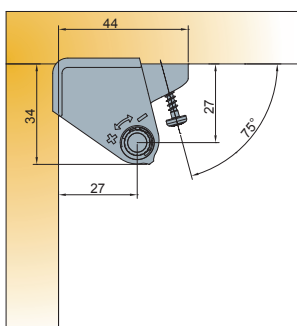

Further explanations → go to http://www.youtube.com/watch?v=8-uWs_z2d0s

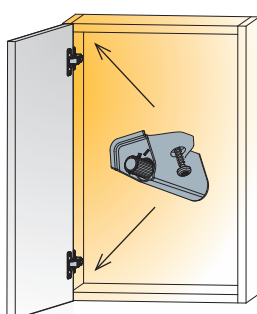

Mount Glissando CR on the hinged side of the cabinet

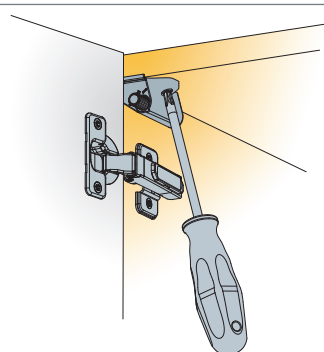

One screw fixing



The functioning of Glissando CR depends of the hinge's closing force. A trial mounting is always recommended.

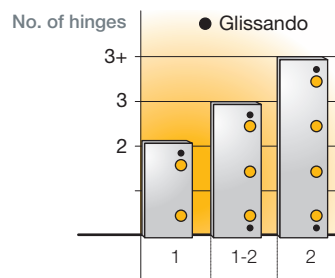

Recommended number per door and positioning

Titusoft WD

Soft Closing System for Wooden Drawer

For wooden drawer
with roller runners

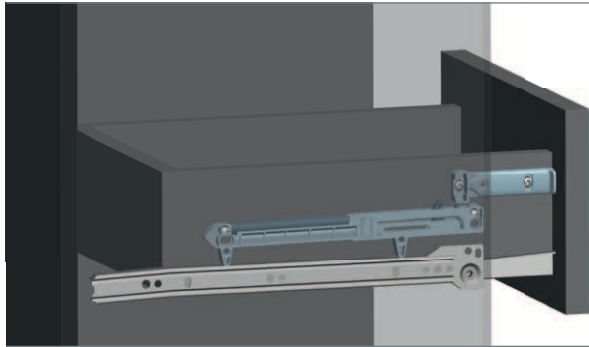
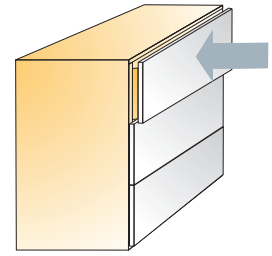

Technical details

Titusoft WD

Titusoft
mechanism

Item number

973-0X35 →

Grey

380

White

Zinc plated
blue

Activator

973-4451 →

380

350



Titusoft mechanism

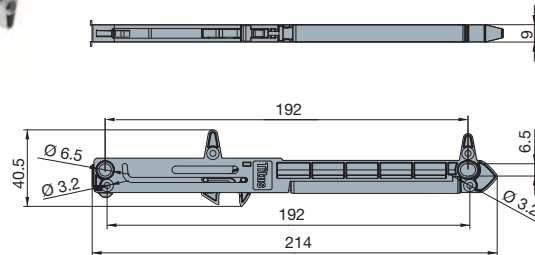

Activator

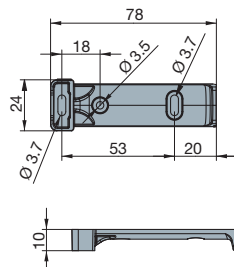

Bag of 1

973-0X35-380-K2  120 Bags

- 1 Titusoft mechanism
- 1 activator
- 2 screws Ø3.5mm x 20mm
- 2 screws Ø3.5mm x 12mm
- 1 Mounting instruction sheet

Bag of 2

973-0X35-380-K1  80 Bags

- 2 Titusoft housings
- 2 activators
- 4 screws Ø3.5mm x 20mm
- 4 screws Ø3.5mm x 12mm
- 1 Mounting instruction sheet

 250 Pcs

Made of plastic

- Works with most roller runner drawer slides
- Easy, intuitive mounting
- Smooth soft closing action independent of drawer hardware
- Optimal closing speed
- Non handed design

Capacity chart

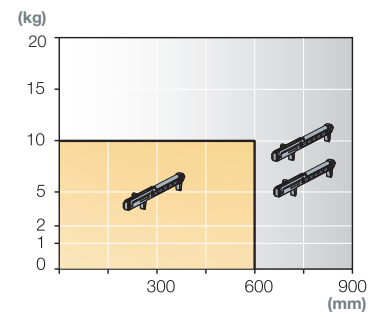

Mount 1 or 2 Titusoft mechanisms depending on drawer weight and width

Mounting details

1.

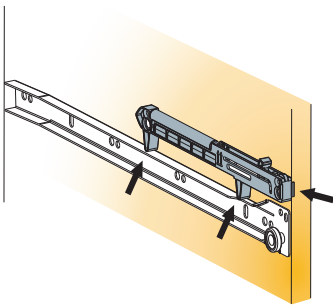

Position the Titusoft mechanism on the top of the drawer slide

2.

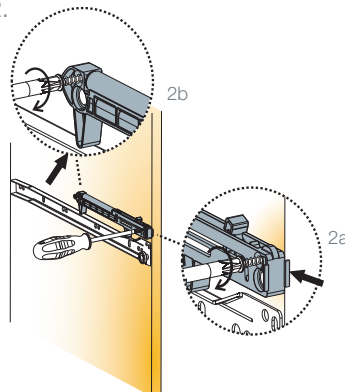

Fix with 2 screws L=20mm

3.

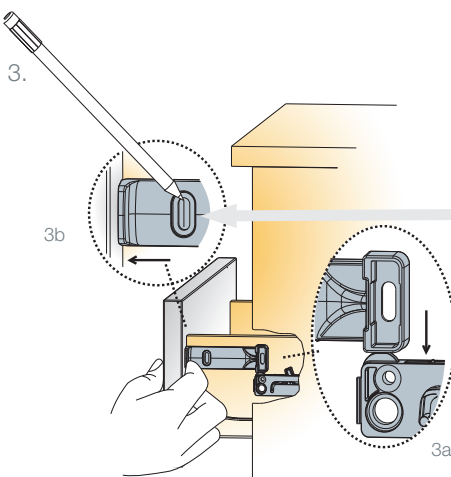

1. Rest the activator against the drawer front
2. Align the vertical position of the activator with the top of the Titusoft mechanism and mark the screw locations

4.

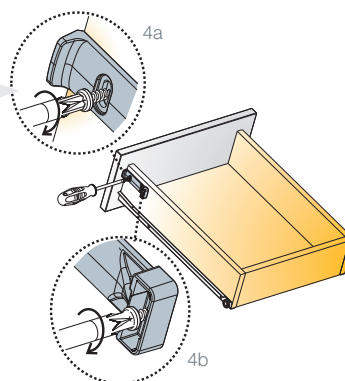

Fix with 2 screws L=12mm



Further explanations → go to

<http://www.youtube.com/watch?v=U3aS2r6KC6k>

A trial mounting is always recommended. Please contact Titus Group or your local distributor for further technical assistance.

Titusoft FF

Soft Closing System
for Face Frame Cabinets
with Wooden Drawer

For wooden drawer
with roller runners

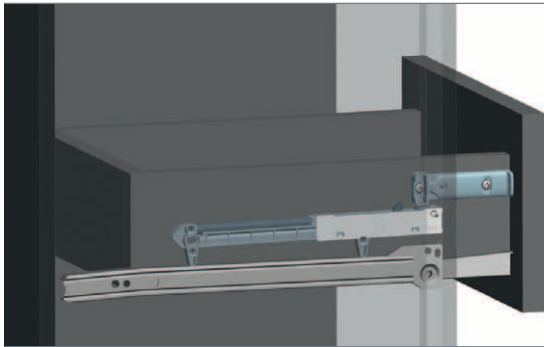
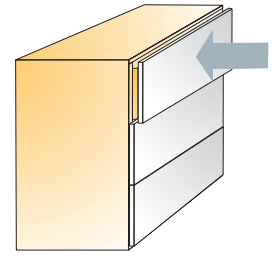

Technical details

Titusoft FF

Titusoft
mechanism

Item number

973-0M99 →

Grey

380

White

350

Zinc plated
blue

Activator

973-4451 →

380

350

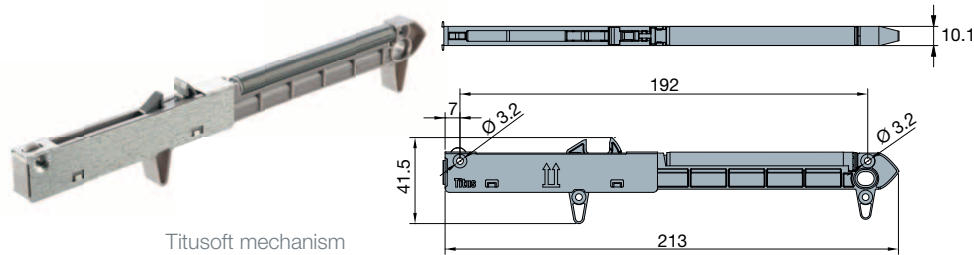

Titusoft mechanism

Bag of 1

973-0M99-380-K1  300 Bags

- 1 Titusoft mechanisms
- 1 activators, grey
- 2 screws Ø3.5mm x 25mm
- 2 screws Ø3.5mm x 12mm
- 1 mounting instruction sheet



Activator

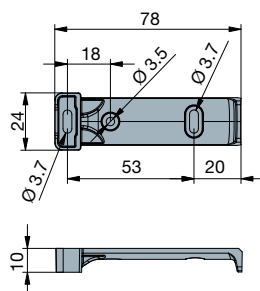

 250 Pcs

Made of plastic

- Easy, intuitive mounting
- Universal application will fit most standard drawers
- Smooth soft closing action independent of drawer hardware
- Non handed design

Capacity chart

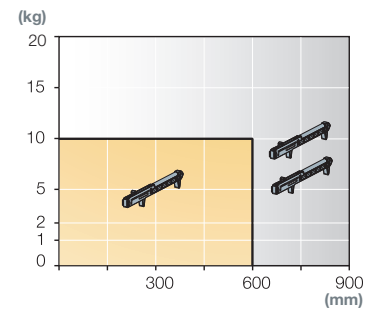

Mount 1 or 2 Titusoft mechanisms depending on drawer weight and width

Mounting details

1.

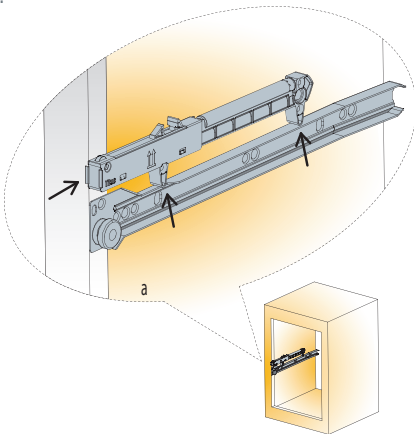

Position the Titusoft on the top of a drawer slide

2.

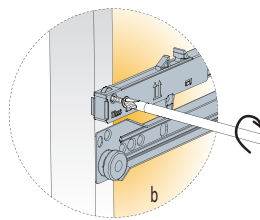

Screw the Titusoft mechanism to the face frame

3.

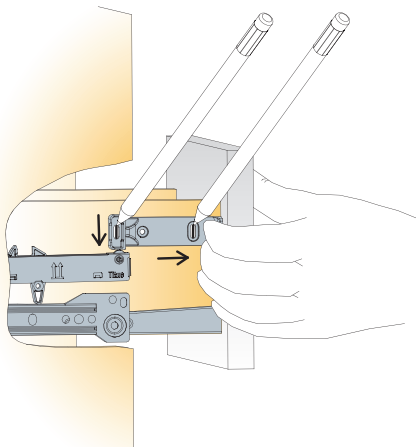

Align the activator with the top of the Titusoft mechanism and fix with two screws

4.

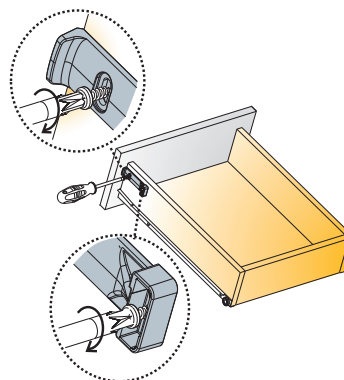

Fix with 2 (3) screws L=12mm



Further explanations → go to

<http://www.youtube.com/watch?v=iQ8DIMlkxbg>

A trial mounting is always recommended. Please contact Titus Group or your local distributor for further technical assistance.

Titusoft MD

Soft Closing System for Metal Box

For metal boxes

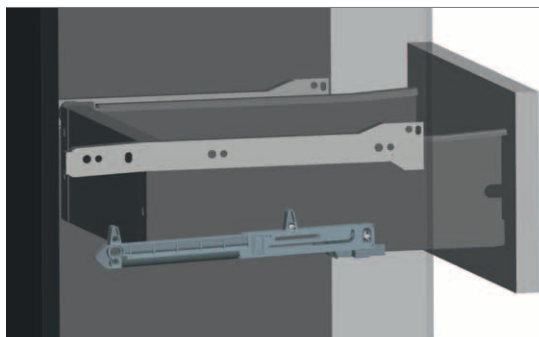
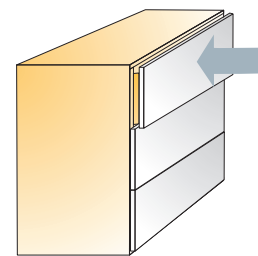

Titusoft MD

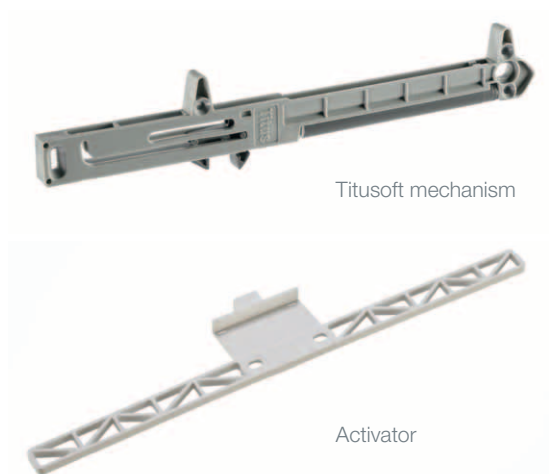

Titusoft mechanism

Activator

Mounting jig

Item number	Color		
	Grey	White	Light blue
Titusoft mechanism for factory mounting 973-0X95 →	380		
Titusoft mechanism for retrofit mounting 973-0X39 →	380		309
Activator 973-4125 →		350	
Mounting jig 973-4126 →			

- Bag of 1**
973-0X39-380-K2 90 Bags
- 1 Titusoft mechanism
 - 1 activator
 - 1 mounting jig
 - 4 screws
 - 1 mounting instruction sheet
- Bag of 2**
973-0X39-380-K1 60 Bags
- 2 Titusoft mechanisms
 - 2 activators
 - 1 mounting jig
 - 8 screws
 - 1 mounting instruction sheet

250 Pcs

Made of plastic

Technical details

Retrofit mounting

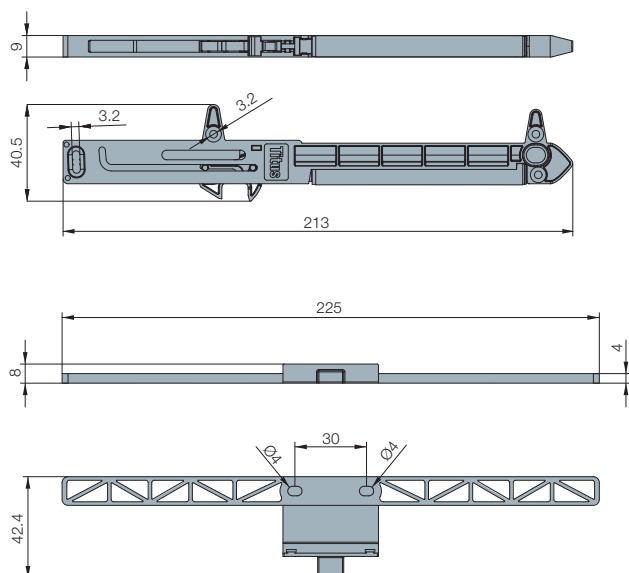

Factory mounting (system holes)

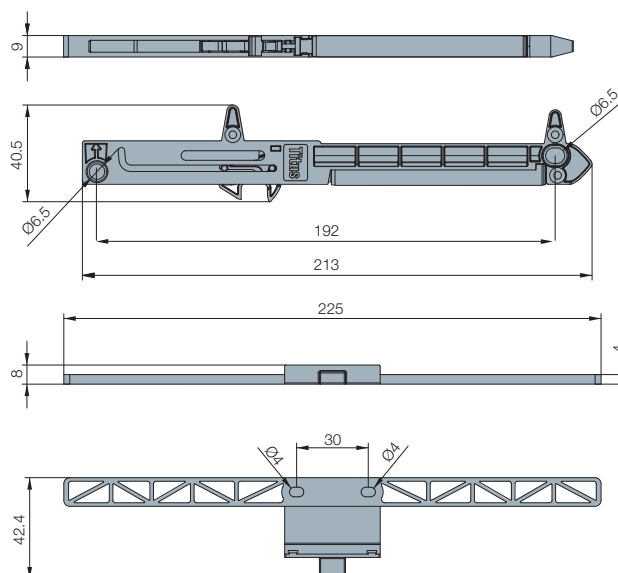

- 'One-for-all' soft closing for single skin metal boxes
- Allows for easy factory mounting or retrofit application
- Intuitive positioning
- Preserve the life-time of the drawer

Capacity chart

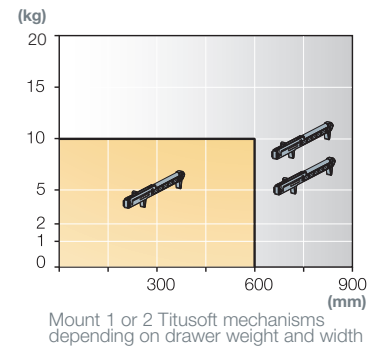

Mounting details

Retrofit mounting

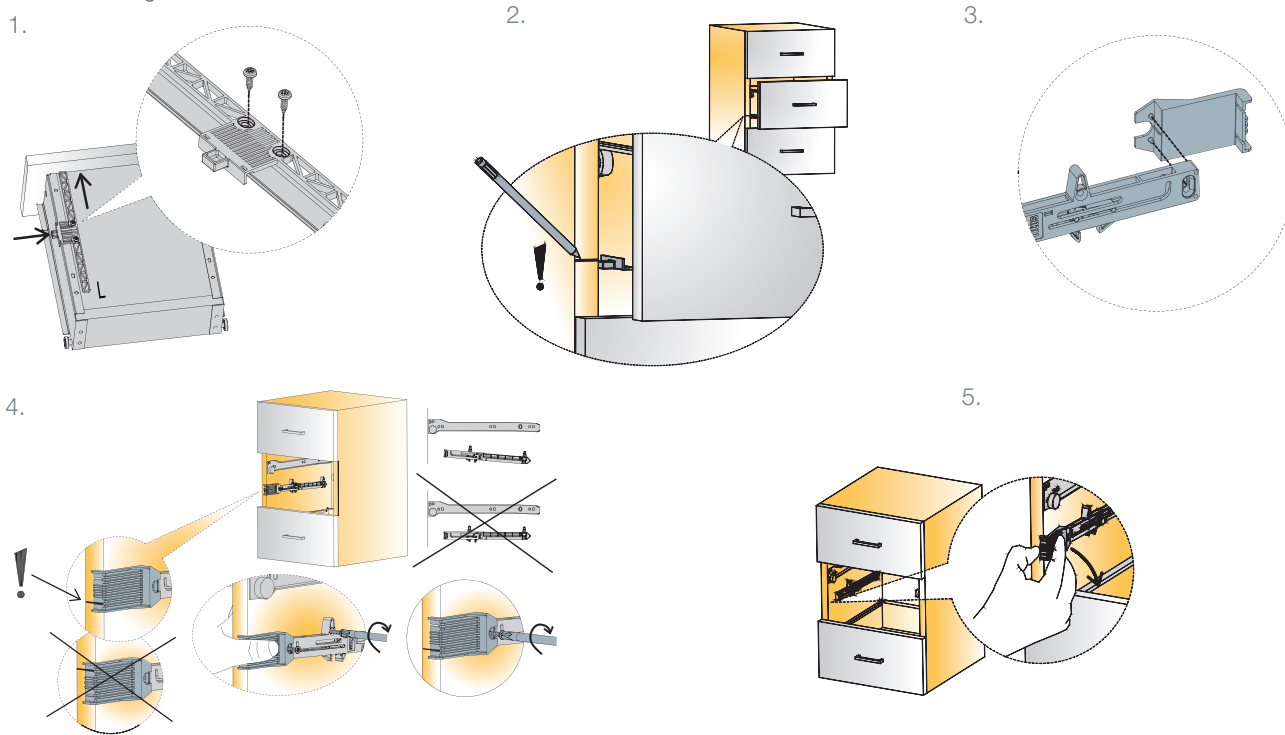

Factory mounting

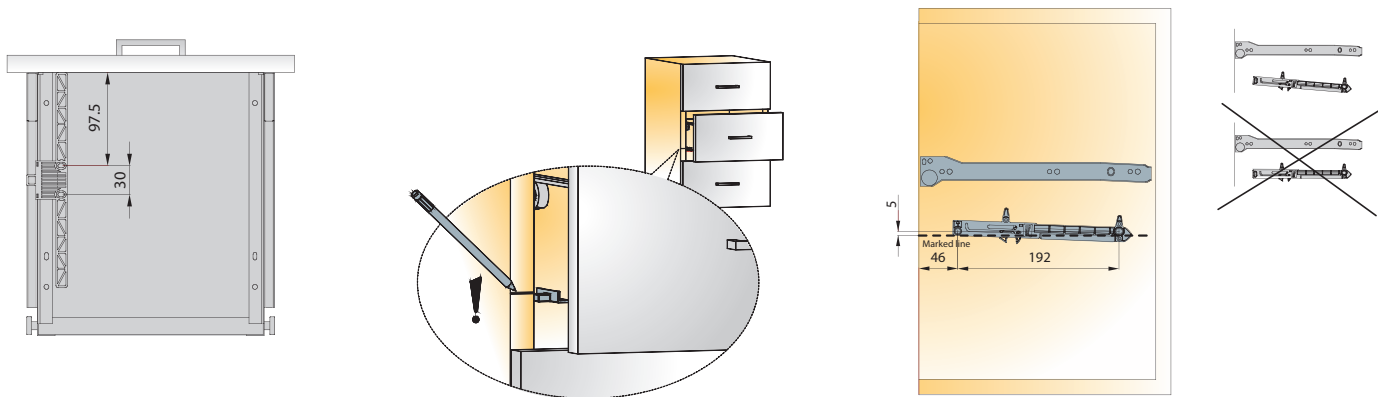

Further explanations → go to

<http://www.youtube.com/watch?v=Qplq8uKGbng>

A trial mounting is always recommended. Please contact Titus Group or your local distributor for further technical assistance.

Titusoft SD100

Add-on Damper for Sliding Door

For top running sliding door systems

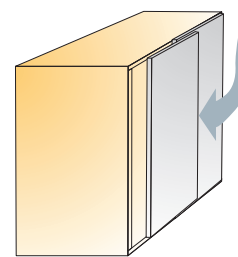

Titusoft SD100

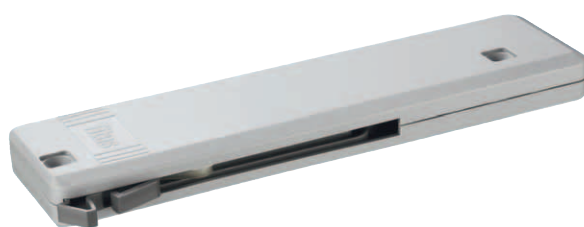

Technical details

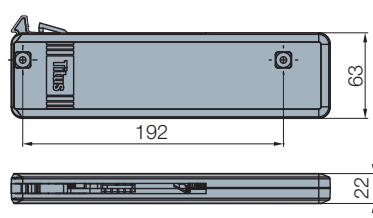

Drilling details

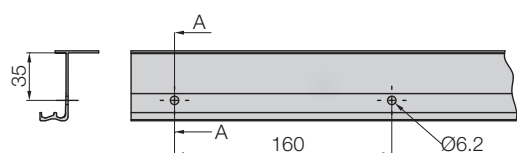

 32 Sets

Item number

973-9018 →

Grey

380

The system consists of the following components

Quantity for 2 door cabinet

Standard component

Titusoft SD100 mechanism



2 pcs

Customized components to suit the customer's sliding door system

Base

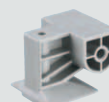

4 pcs

Stopper



2 pcs

Activator for internal door



1 pc

Activator for external door



1 pc

Accessories

Screws

Countersunk screw D4x40mm

Countersunk screw D4x25mm

Chipboard screw Ø4x16mm

Eurocrew Ø6.3x15mm

4 pcs

4 pcs

3 pcs

2 pcs

Mounting instructions



1 pc

Titusoft SD100 capacity

- 'ConfidentClose'
- Intuitive mounting
- Non-handed design
- Efficient damping on different door sizes
- Smooth and controlled closing motion

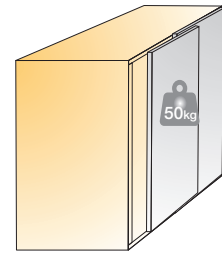

Up to 50kg per door

Mounting details

Non-handed design

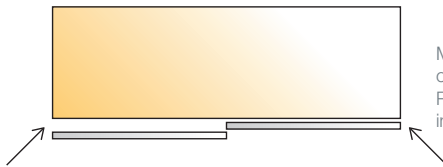

Mount Titusoft SD100 on top rail on both sides of the cabinet. Please follow mounting instructions included in a set.

Mounting positions

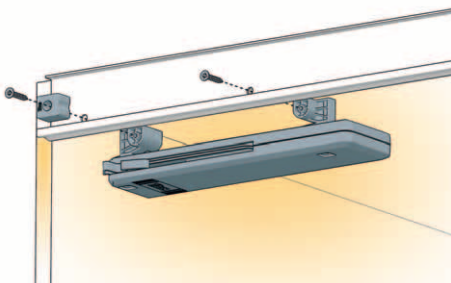

Titusoft SD100 mechanism position

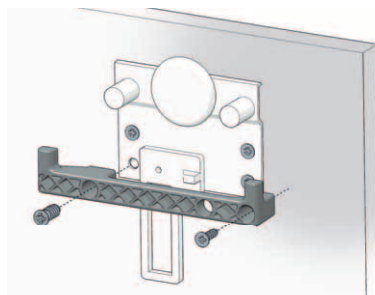

* Activator for internal door position

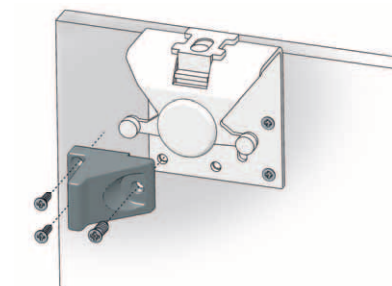

* Activator for external door position

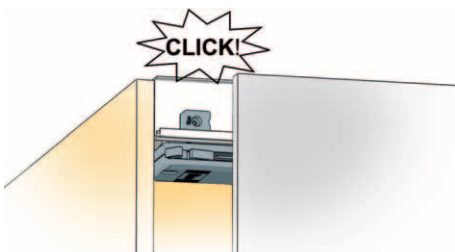

Click to engage



* Activators are customized to suit specific sliding door system. Please contact your Titus Group representative for further information.

Concealed Hinges

Titus Hinges

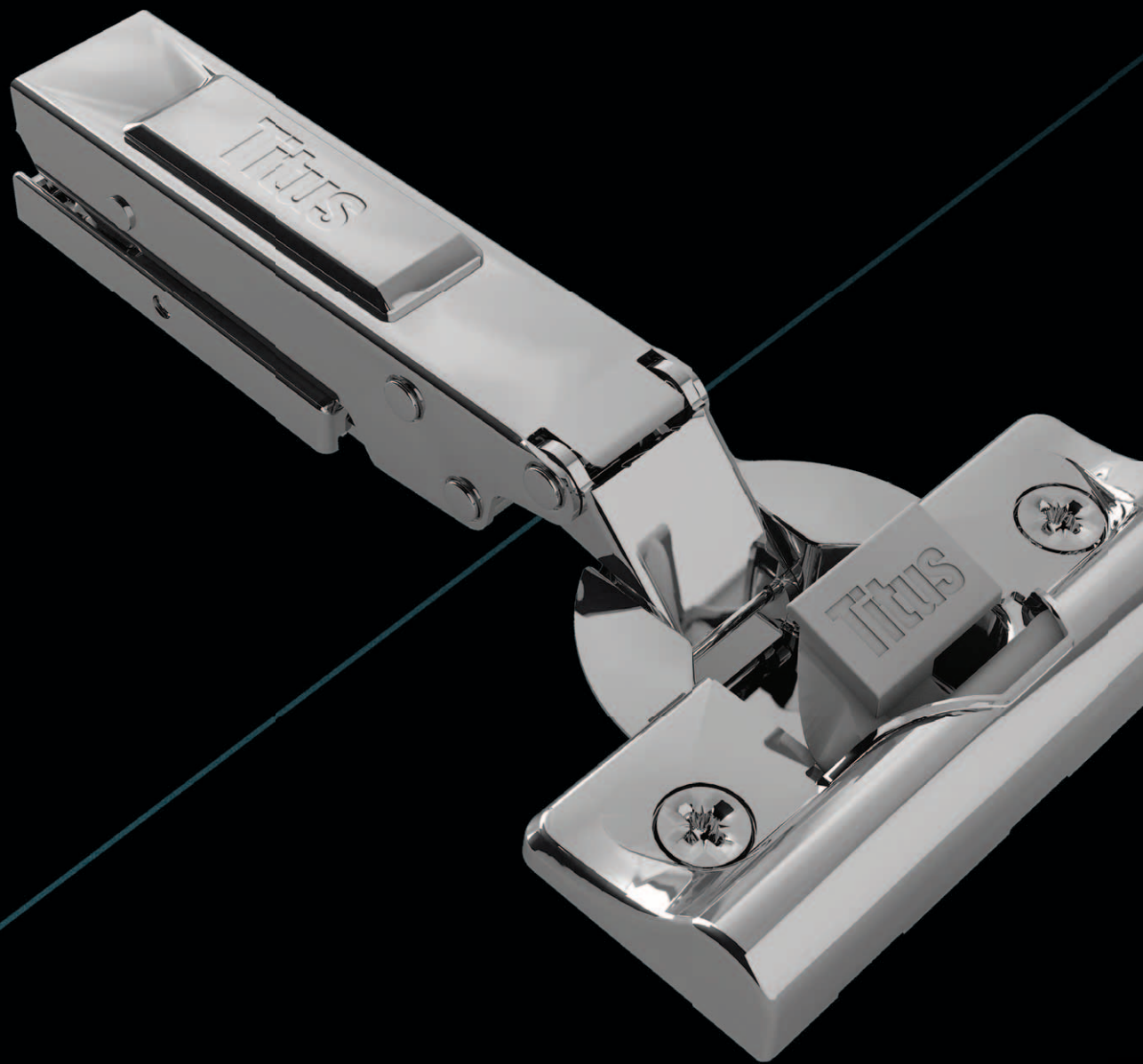

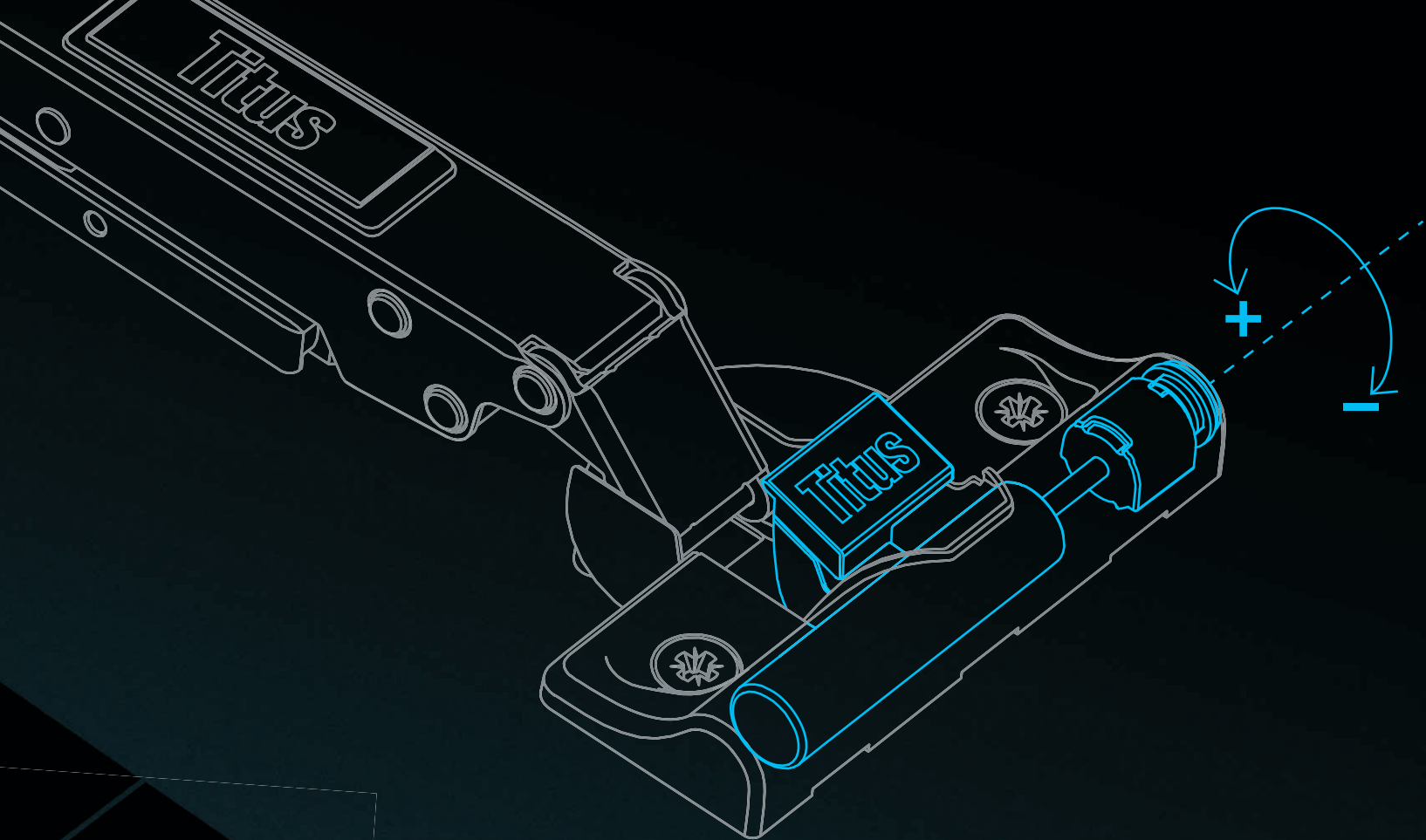

'ConfidentClose'

The hinge is designed to provide consumer preferred way of soft closing action.

- Fast closing
- Late start of deceleration action
- Quiet landing with 'SoftTouch'

Based on independent consumer researches.

'One-for-All'

- Damping on the hinge cup
- Damper, positioned transversal to the hinge cup allows for easy introduction of various hinge versions
- Damped and non-damped version on one mounting plate platform

Adjustable Damping

Flexibility to tune performance to wide range of applications

- Consistent performance over a wide range of doors of different sizes and weights
- Easy accessible button for intuitive and quick adjustment

Titus Damper Inside

- Efficient damping at any closing speed
- Reliable closing
- Damping force consistency

A Comprehensive Range

T-type hinge



Titus New Generation hinge for quick furniture assembly and consistent performance on wide range of doors

'3Way' 'snap-on' mounting

Highly tolerant

Adjustable damping

'ConfidentClose'

Numerous application possibilities

- for simpler cabinet design
- for demanding high quality furniture of larger heights and weights

S-type hinge



Simple and quick 'snap-on' mounting system

Easy assembly and disassembly

Adjustable damping

'ConfidentClose'

Push to open for handleless furniture

B-type hinge



Reliable slide-on mounting system

Simplicity in use

Adjustable damping

'ConfidentClose'

Reliable door closing

Opening angle	Door thickness	Cranking	Door tab K	Mounting mode	Mounting plate type	Mounting plate height	Soft closing options	Durability (cycles)	Page
110° 120° 170°	15-26mm	0mm 5mm 9mm 17mm angled	3-6mm	'3Way' snap-on	cruciform linear for face frame	0mm 1mm 2mm 3mm 4mm	Damping integrated in the hinge cup Glissando add-on or stand-alone damping solutions	100.000	1.26
110° 170°	16-24mm	0mm 9mm 15mm angled	3-5mm	snap-on	cruciform for face frame	0mm 1mm 2mm 3mm	Damping integrated in the hinge cup Glissando add-on or stand-alone damping solutions	80.000	1.53
110° 170°	16-24mm	0mm 9mm 15mm angled	3-5mm	slide-on	cruciform	0mm 1mm 2mm 3mm	Damping integrated in the hinge cup Glissando add-on or stand-alone damping solutions	80.000	1.101

Concealed Hinges

Product Guide

	Cranking	Opening angle	Cup type	Page
T-type				
T-type Glissando 110	0mm	110°	for wood door	3.27
	5mm	110°	for wood door	3.27
	9mm	110°	for wood door	3.29
	17mm	110°	for wood door	3.29
T-type Glissando 120	0mm	120°	for wood door	3.31
	9mm	120°	for wood door	3.31
T-type Glissando 110/45°	45°, 17mm	110°	for wood door	3.33
T-type Glissando 110/90°	90°, 17mm	110°	for wood door	3.35
T-type 110	0mm	110°	for wood door	3.37
	5mm	110°	for wood door	3.37
	9mm	110°	for wood door	3.39
	17mm	110°	for wood door	3.39
T-type 120	0mm	120°	for wood door	3.41
	9mm	120°	for wood door	3.41
T-type 110/45°	45°, 17mm	110°	for wood door	3.43
T-type 110/90°	90°, 17mm	110°	for wood door	3.45
T-type 170	0mm	170°	for wood door	3.47
	5mm	170°	for wood door	3.47
	9mm	170°	for wood door	3.49
T-type mounting plates				3.51
S-type				
S-type-i plus 110	0mm	110°	for wood door	3.57
	9mm	110°	for wood door	3.57
S-type-i 110	0mm	110°	for wood door	3.59
	9mm	110°	for wood door	3.59
	15mm	110°	for wood door	3.59
S-type-i 110/30°	30°, 9mm	110°	for wood door	3.61

	Cranking	Opening angle	Cup type	Page
S-type-i 110/45°	45°, 9mm	110°	for wood door	3.63
	45°, 18mm	110°	for wood door	3.65
S-type-i 110/90°	90°, 18mm	110°	for wood door	3.67
S-type plus 110	0mm	110°	for wood door	3.69
	9mm	110°	for wood door	3.69
S-type plus 110 Touch opening	0mm	110°	for wood door	3.71
	9mm	110°	for wood door	3.71
S-type 110	0mm	110°	for wood door	3.73
	9mm	110°	for wood door	3.73
	15mm	110°	for wood door	3.73
S-type 110/-15°	-15°, 0mm	110°	for wood door	3.75
S-type 110/15°	15°, 0mm	110°	for wood door	3.77
S-type 110/24°	24°, 9mm	110°	for wood door	3.79
S-type 110/30°	30°, 9mm	110°	for wood door	3.81
S-type 110/45°	45°, 9mm	110°	for wood door	3.83
	45°, 18mm	110°	for wood door	3.85
S-type 110/90°	90°, 18mm	110°	for wood door	3.87
S-type 110	0mm	110°	for aluminium frame door	3.89
S-type 170	0mm	165°	for wood door	3.91
	9mm	165°	for wood door	3.93
S-type for pie-cut corner cabinet			for wood door	3.95
S-type mounting plates				3.97
B-type				
B-type-i 110	0mm	110°	for wood door	3.105
	9mm	110°	for wood door	3.105
	15mm	110°	for wood door	3.105
B-type-i 110/30°	30°, 9mm	110°	for wood door	3.107
B-type-i 110/45°	45°, 9mm	110°	for wood door	3.109

	Cranking	Opening angle	Cup type	Page
	45°, 18mm	110°	for wood door	3.111
B-type-i 110/90°	90°, 18mm	110°	for wood door	3.113
B-type 110	0mm	110°	for wood door	3.115
	9mm	110°	for wood door	3.115
	15mm	110°	for wood door	3.115
B-type 110/30°	30°, 9mm	110°	for wood door	3.117
B-type 110/45°	45°, 9mm	110°	for wood door	3.119
	45°, 18mm	110°	for wood door	3.121
B-type 110/90°	90°, 0mm	110°	for wood door	3.123
	90°, 18mm	110°	for wood door	3.123
B-type 110	0mm	165°	for aluminium frame door	3.125
B-type 170	0mm	165°	for wood door	3.127
	9mm	165°	for wood door	3.129
B-type for pie-cut corner cabinet			for wood door	3.131
B-type flap door hinge	0mm	90°	for wood door	3.133
B-type mounting plates				3.135
Hinge Ø40	0mm	93°	for wood door	3.139
	10mm	93°	for wood door	3.139
	18mm	93°	for wood door	3.141
	22mm	93°	for wood door	3.141
Hinge Ø40 mounting plates				3.143

Other Hinges

Wide angle hinge and mounting plate	270°	for wood door	3.145
Refrigerator cabinet door hinge	110°	for wood door	3.147

Accessories

Push latch			3.149
Cover caps			3.151

Concealed Hinges

Door Overlay

How to Achieve the Desired Door Overlay?

By choosing the hinge of appropriate cranking

Concealed hinges with specific hinge arms are available for different door overlays. The most common overlays are:

■ Cabinet side
■ Door



- 1. Full overlay**
Use a hinge with 0mm cranking

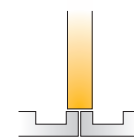

- 2. Partial overlay for double doors**
Use a hinge with 5mm or 9mm cranking



- 3. Inset door**
Use a hinge with 15mm or 17mm cranking

By choosing the mounting plates of appropriate thickness

To achieve the desired overlay (x) while using a determined drilling distance (K), a mounting plate of appropriate

thickness (D) must be chosen from the enclosed table or calculated with given formula.

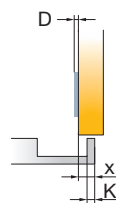

x	4	5	6	7	8	9
3	3	2	1	0		
K 4		3	2	1	0	
5			3	2	1	0

$$D = 4 + K \cdot x$$

By choosing the appropriate drilling distance K

To achieve the desired door overlay (x) while using a determined mounting plate thickness (D), an appropriate drilling distance K must be chosen.

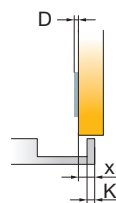

x	4	5	6	7	8	9
0				3	4	5
1			3	4	5	
D 2				5		
3	3	4	5			

Through side adjustment

The side adjustment is made by rotating the appropriate screw on the hinge arm.

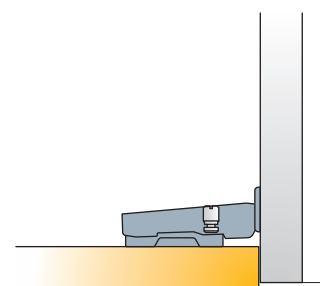
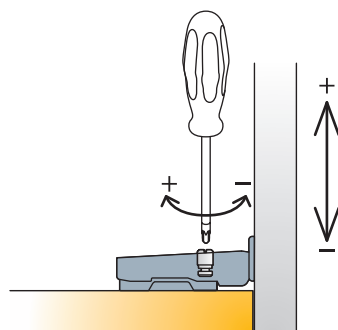
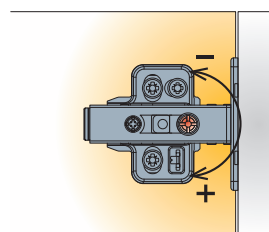

Adjustment range

Door clearance and gap

The door clearance ($F \geq F_{min}$) and gap (Z) represent the minimal necessary space needed for the correct opening and closing of the door. The minimal required values depend on the cup drilling distance (K), door thickness (V)

and the type of hinge. The minimum clearance scale can be found on product pages → see Door clearance chart. When using hinges with partial overlay the door clearance must be twice as large ($F \geq 2F_{min}$).

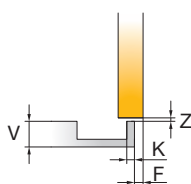

V	16	17	18	19	20	21	22	
3	0.3	0.5	0.7	1.0	1.3	1.7	2.5	
K	4	0.3	0.5	0.7	0.9	1.2	1.6	2.1
5	0.3	0.5	0.7	0.9	1.2	1.5	2.0	F_{min}

Gap $Z_{min}=0$

Concealed Hinges

Hinge Cup Types

How to Mount the Hinge on the Door?

There are cup type symbols listed on product pages beside item numbers. Below you can find their explanation.

No pre-mounting

The hinge is fixed on the door with two screws. 3mm pilot holes recommended.

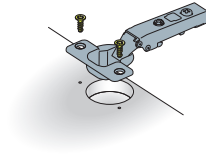

Easy-Fix time saving system

Quarter turn fixing for 8mm holes (interaxis 45/9.5) or 10mm holes (interaxis 48/6 and 52/5.5).

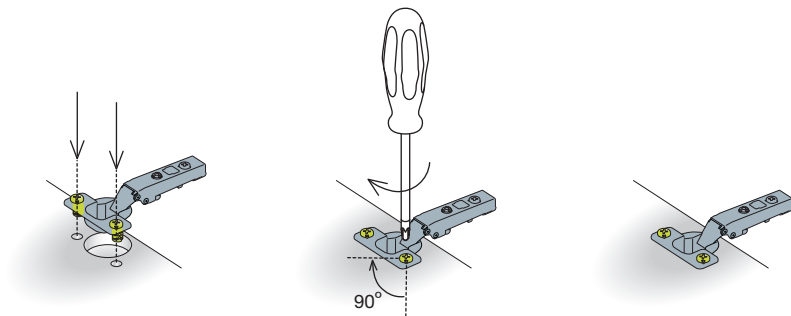

Machine insertion ready hinge cup

Premounted dowels suitable for machine insertion into 8mm holes (interaxis 45/9.5) or 10mm holes (interaxis 48/6 and 52/5.5)

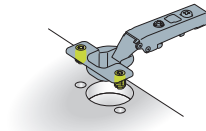

Pre-mounted expando dowels

Pre-mounted expanding dowels with triple-start screw for fast fixing, suitable for 8mm holes.

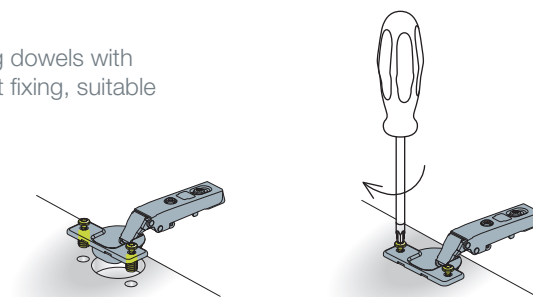



Hinge cup with pre-mounted euro screws

Pre-mounted euro screws for 5mm holes. Where not specified otherwise, euro screws are 13mm long.

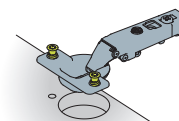

Hinge cup with pre-mounted chipboard screws

Pre-mounted chipboard screws. 3mm pilot holes recommended.

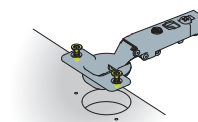

Aluminium frame screw-on hinge cup

The hinge is fixed onto a specific drilling on the aluminium frame.

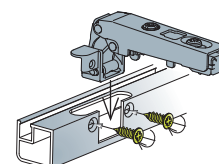

Concealed Hinges











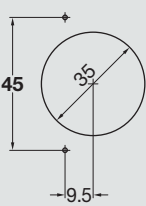
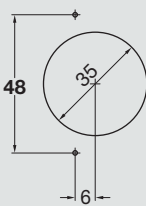
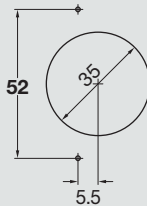

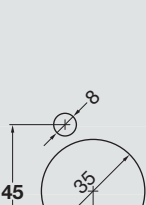
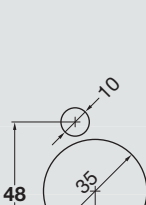
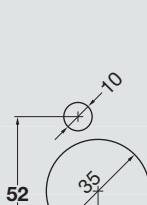

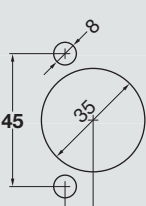
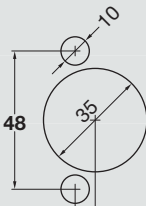
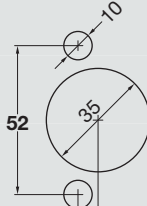
Boring Details

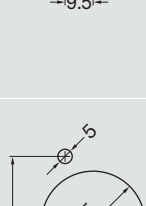
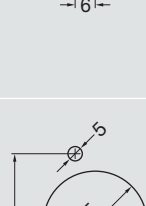
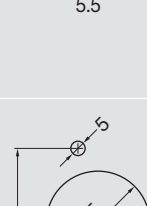
Drilling Patterns for Hinge Cup

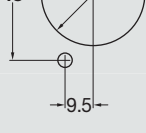
Interaxis 45mm, 48mm and 52mm*

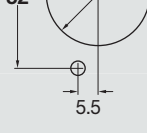
- T-type
- S-type
- B-type

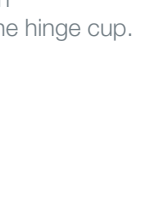
*Available on special request → see page 3.9

	Interaxis 45mm	Interaxis 48mm	Interaxis 52mm
Hinge cup type	Drilling pattern	Drilling pattern	Drilling pattern
 Screw-on ready			
 Premounted chipboard screws			
 Machine insertion ready			
 Premounted expando dowels			
 Easy-fix system			
 Premounted euro screws			

Interaxis is the distance between two holes for fixing screws on the hinge cup.

Concealed Hinges

Mounting Plate Type

How to Fix the Mounting Plate on the Cabinet Side?

There are mounting plate type symbols listed on product pages beside item numbers. Below you can find their explanation.

 **No pre-mounting, chipboard screw ready**

The mounting plate is fixed with two chipboard screws or equivalent. 3mm pilot holes recommended.

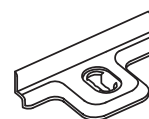

 **No pre-mounting, euro screw ready**

Fixing with 6.3mm euro screws into pre-drilled 5mm holes. To choose appropriate head and length for use with this mounting plate is recommended.

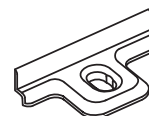

 **Machine insertion ready**

Pre-mounted dowels for machine insertion into 10mm holes.

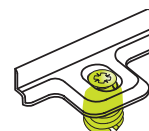

 **Pre-mounted euro screws**

Euro screws for 5mm holes are pre-mounted on the mounting plate. Available lengths: 11mm, 13mm and 15mm

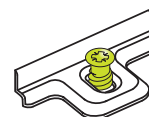

 **Pre-mounted expanding dowels**

Pre-mounted expanding dowels for 5mm holes. Available lengths: 7.5mm and 10.5mm

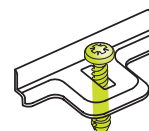

 **Pre-mounted chipboard screws**

The mounting plate is fixed with two pre-mounted chipboard screws. 3mm pilot holes recommended.

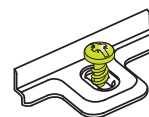

Concealed Hinges

Hinge-to-plate Mounting

How to Assemble the Hinge and the Mounting Plate?

T-type
'3Way' 'snap-on'

'3Way' 'snap-on' mounting for intuitive hinge-to-plate assembly in three directions:

- from the hinge arm front
- from the hinge arm rear
- from the top

front assembly

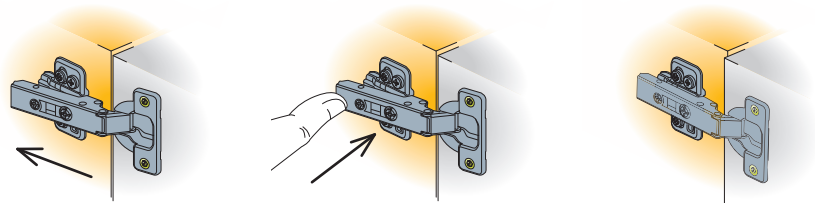

rear assembly

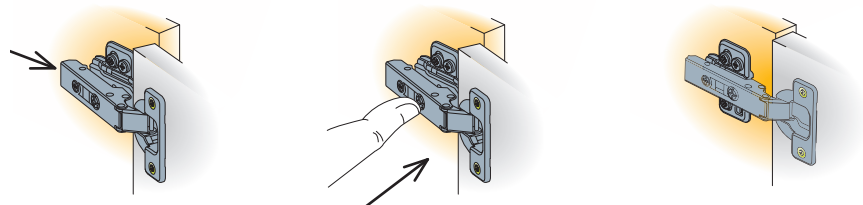

top assembly



disassembly:
for disassembly press rear
button on the hinge arm.

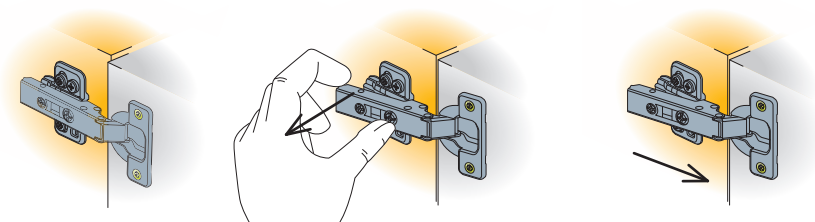

S-type 'snap-on'

The door is assembled on the cabinet side simply by positioning the two hooks under the hinge arm on the outer part of the mounting plate and pressing gently on the rear part of the hinge arm.

For disassembly press the rear button on the hinge arm.

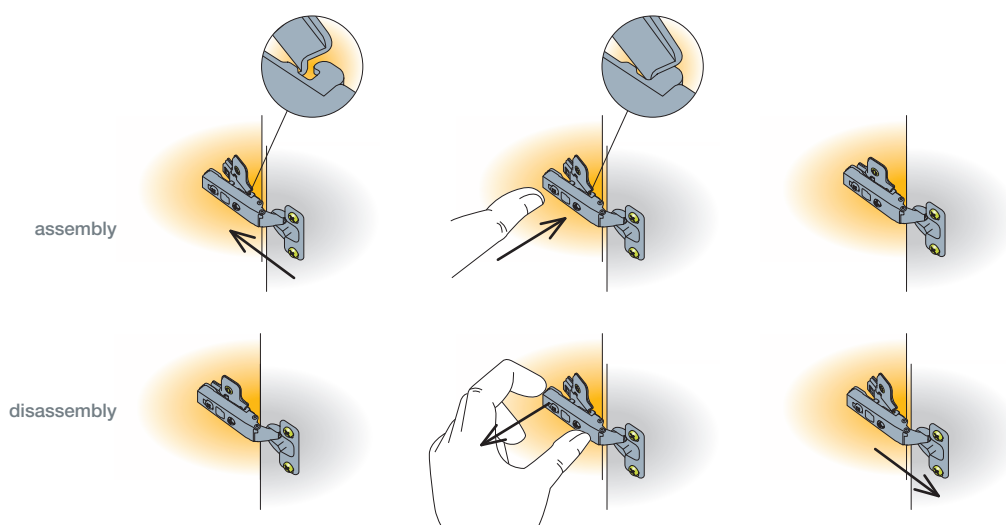

B-type slide-on

The hinge is assembled by sliding the hinge arm over the mounting plate. The hinge adjustment screw must fit into the groove on the mounting plate.

After adjusting the door depth, the mounting procedure is finished by tightening the fixing screw.

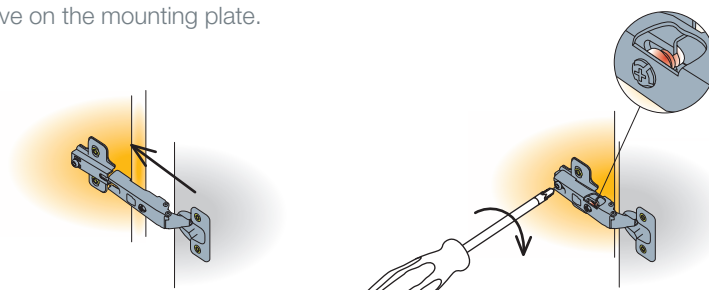

Key-hole

- Wide angle hinge
- Refrigerator cabinet door hinge

The hinge is assembled on the mounting plate by inserting the fixing screw on the appropriate hole on the hinge arm.

After adjusting the door depth, the mounting procedure is finished by tightening the fixing screw.

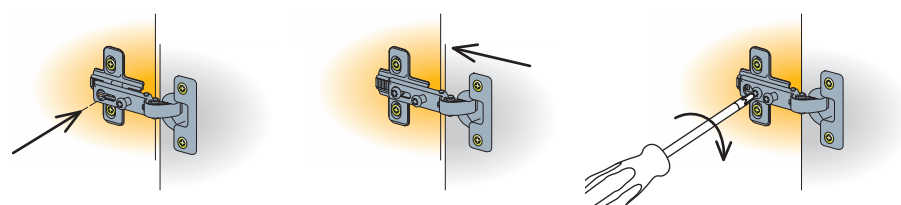

Concealed Hinges

Loadings



Use the appropriate number of hinges so that the door height or weight does not exceed that shown below.

How Many Hinges per Door?

Check the enclosed specifications for the number of required hinges per door by considering door height and weight.

Concealed hinges with Ø 35mm hinge cup diameter

- T-type
- S-type
- B-type
- Other hinges

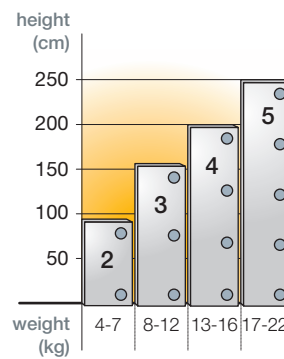

- T-type Glissando
- S-type-i
- B-type-i

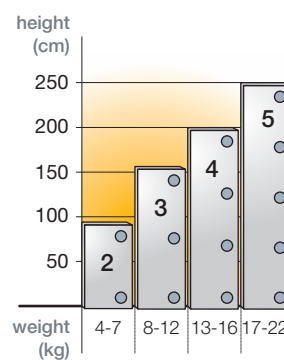

Hinges with integrated damping can be combined with non-damped hinges from standard hinge range. A trial mounting is always recommended.

Concealed Hinges

Adjustment



Adjustment range can be found on the product pages.

Side Adjustment

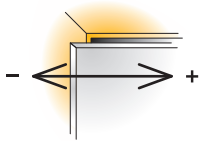

The side adjustment aligns the door with the side of the cabinet.

By rotating the appropriate screw

T-type
S-type
B-type

The side adjustment is made by rotating the screw on the hinge arm.

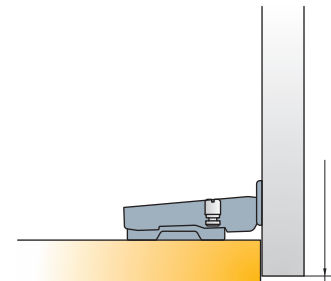
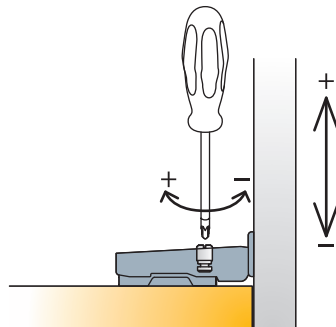
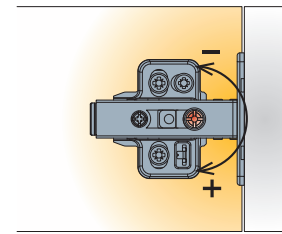

Adjustment range

By temporarily loosening the fixing screw

• Wide angle hinge

For the side adjustment:
1. Release the fixing screw
2. Make the necessary adjustment by rotating the appropriate screw
3. Tighten the fixing screw
Without releasing the fixing screw no side adjustment is possible.

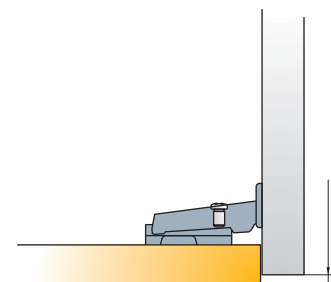
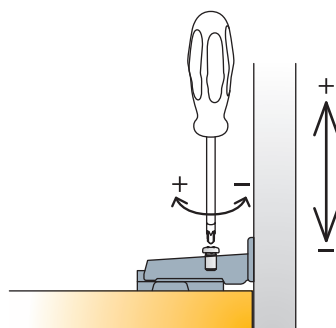

Adjustment range

Concealed Hinges Adjustment

Height Adjustment

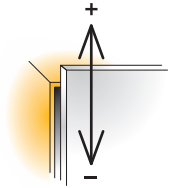

Height adjustment is necessary to achieve optimal vertical door position.

By rotating the cam adjuster

The height adjustment is made by rotating the cam adjuster on the mounting plate.

T-type with cam adjustable cruciform mounting plate

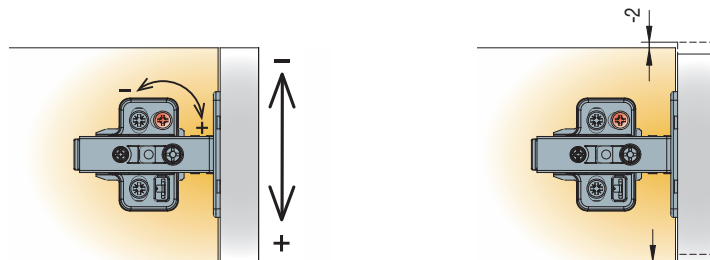

T-type with cam adjustable horizontal mounting plate

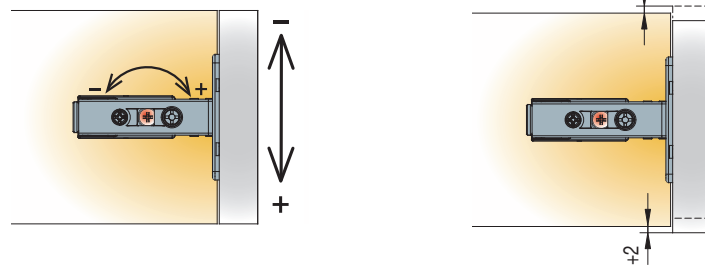

S-type with cam adjustable cruciform mounting plate

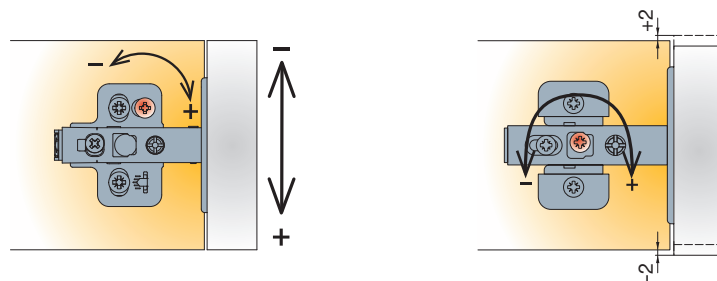

By releasing the screw slot

- T-type and S-type with cruciform mounting plate
- B-type
- Wide angle hinge

For height adjustment the two mounting plate fixing screws have to be temporarily released while making the manual adjustment.

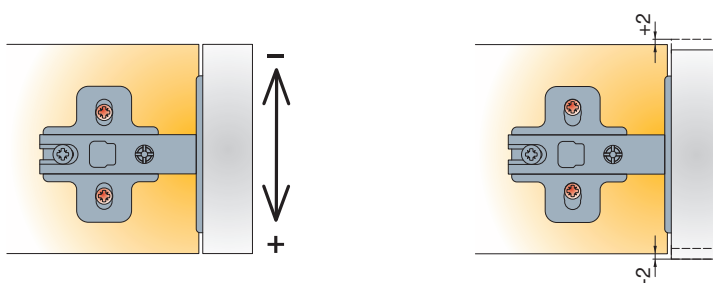

Concealed Hinges

Adjustment

Depth Adjustment

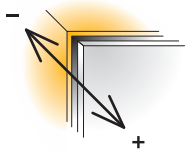

The system enables easy adjustment of the gap between door and cabinet.

By rotating the cam adjuster

Rotate the cam adjuster on the hinge arm.

- T-type

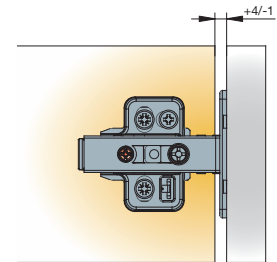
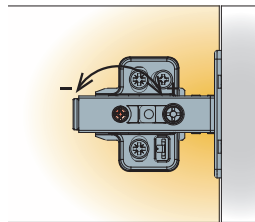

- S-type plus

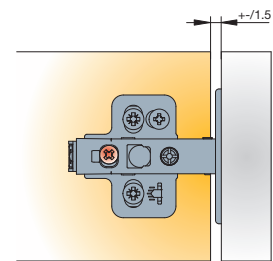
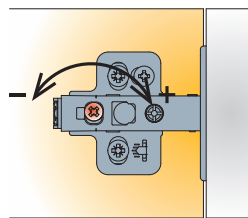

By releasing the fixing or adjustment screw

- S-type
- B-type

The depth adjustment is made by temporarily releasing the adjustment screw (S-type) or fixing screw (B-type, Hinge Ø40). After the adjustment is made the screw has to be re-tightened.

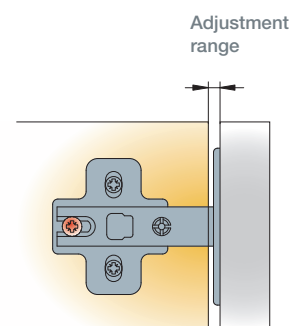
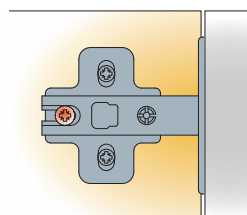

Door Closing Type

There are two door closing systems:

self - closing ←
free - swinging -----

Concealed hinges with self-closing angle

- T-type
- S-type
- B-type

The self-closing angle is the point from which the door will close by itself, without user assistance. The mechanism starts closing the door from a 14° to 25° angle, depending on the concealed hinge type. From that point to the maximum opening angle the door remains in an open position.

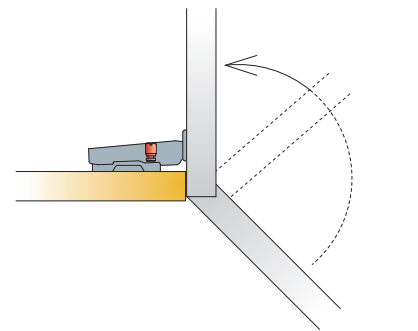

Free-swinging door hinges*

- all series

Optionally most of Titus concealed hinges can be supplied without self-closing mechanism. These hinges may be ordered upon request. Soft closing devices can not be used with free-swinging door hinges.

* Available upon special request → see page 3.9

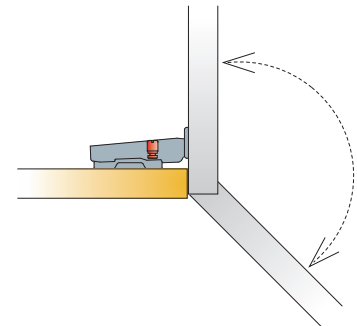

Concealed Hinges Adjustment

Damping Adjustment

T-type Glissando

The damping action can be adjusted to fit different door weights and sizes which enables perfect door functioning.

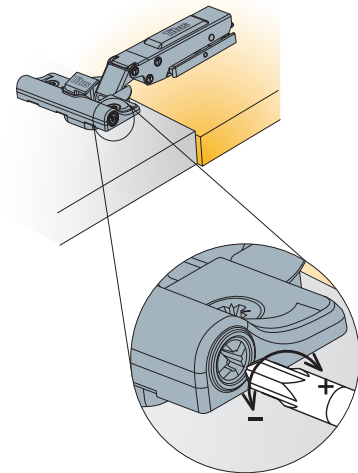

Damping is factory pre-set to the medium damping value. Turn towards '+' to increase and '-' to decrease the damping.

S-type-i plus series S-type-i series B-type-i series

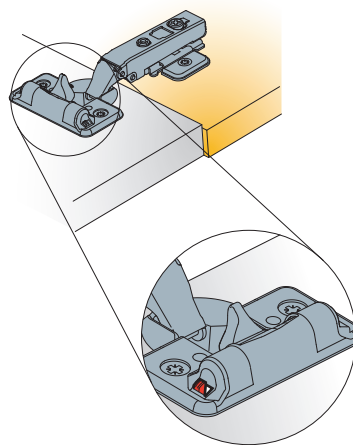

The damping reduction switch in a pre-set position.

To decrease or to increase the damping, change the position of the damping reduction switch. Hinges are factory pre-set to the maximum damping value.

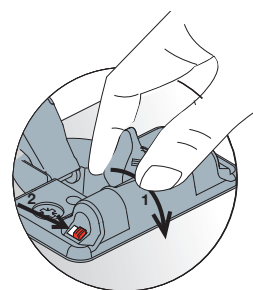

To decrease the damping
1. Lift the damping activator.
2. Slide the damping reduction switch to opposite position.

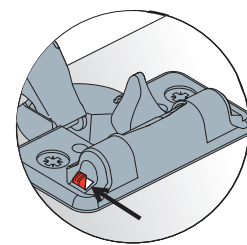

To increase the damping, slide the damping reduction switch back to the factory pre-set position.

Damping force change

The damping reduction switch adjusts the damping. Example shows the damping change in case of two hinges on door.

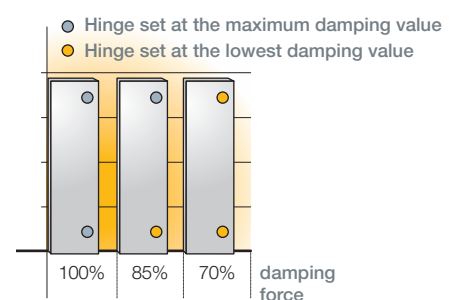

Key Design Choices

'ConfidentClose'

The hinge is designed to provide consumer preferred way of soft closing action.

Based on results of Titus researches made in UK, Germany and Slovenia

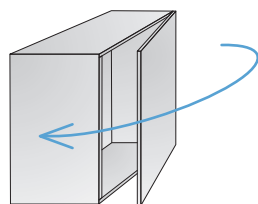

Fast closing

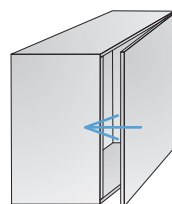

Late start of deceleration action

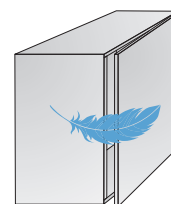

Quiet landing with 'SoftTouch'

'One-for-all' efficiency principle

Damping on the hinge cup
Damper, positioned transversal to the hinge cup allows for easy introduction of various hinge versions

Damped and non-damped version on one mounting plate platform



Adjustable damping

Flexibility to tune performance for all applications

- Consistent performance over a wide range of doors of different sizes and weights
- Easy accessible adjustment button for intuitive and quick adjustment

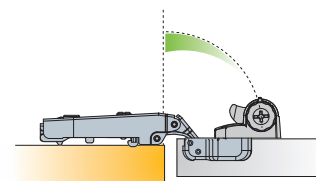

Adjustable damping zone and force

Titus Damper Inside

- Efficient damping at any closing speed
- Reliable closing
- Damping force consistency



T-type Hinges

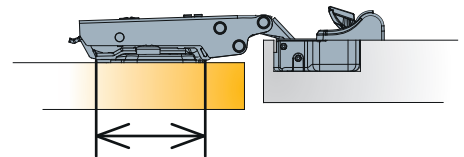
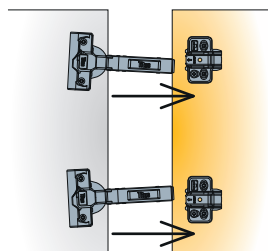
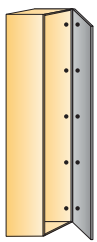
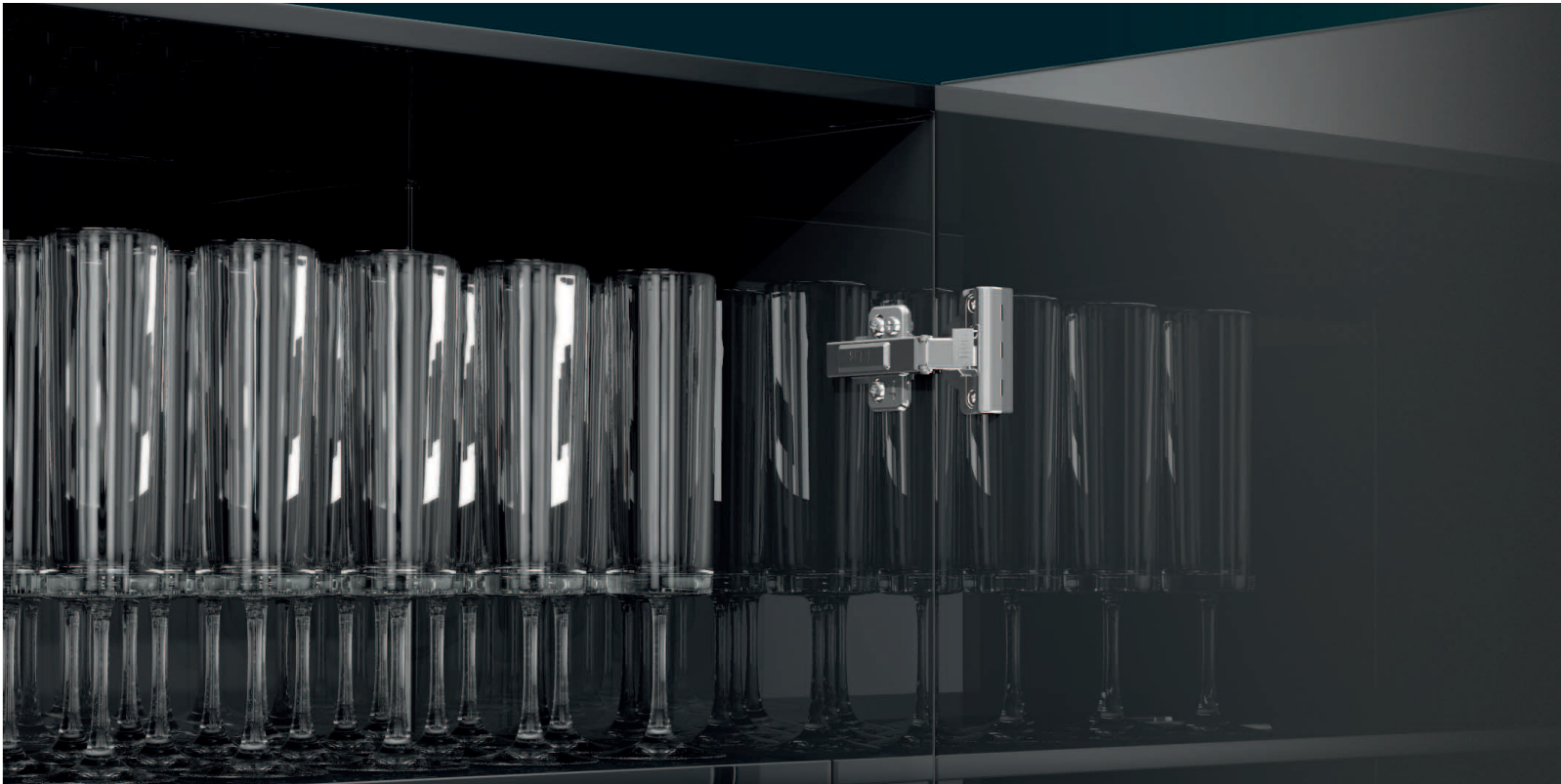

Easy door installation even in cases of 4-5 hinges per door

- Easy and quick assembly and disassembly
- Flexibility for the furniture user
- Tight hinge-to-plate joint improves hinge stability and reduces door sag

Highly tolerant

- Efficient performance in marginal values of tolerances
- Reliable door closing in case of accidental misalignment
- 'ConfidentClose' assured

Rigidity

- Hinge-to-plate attachment assures stability and rigidity
- Smooth performance

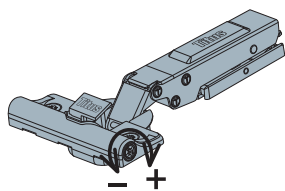
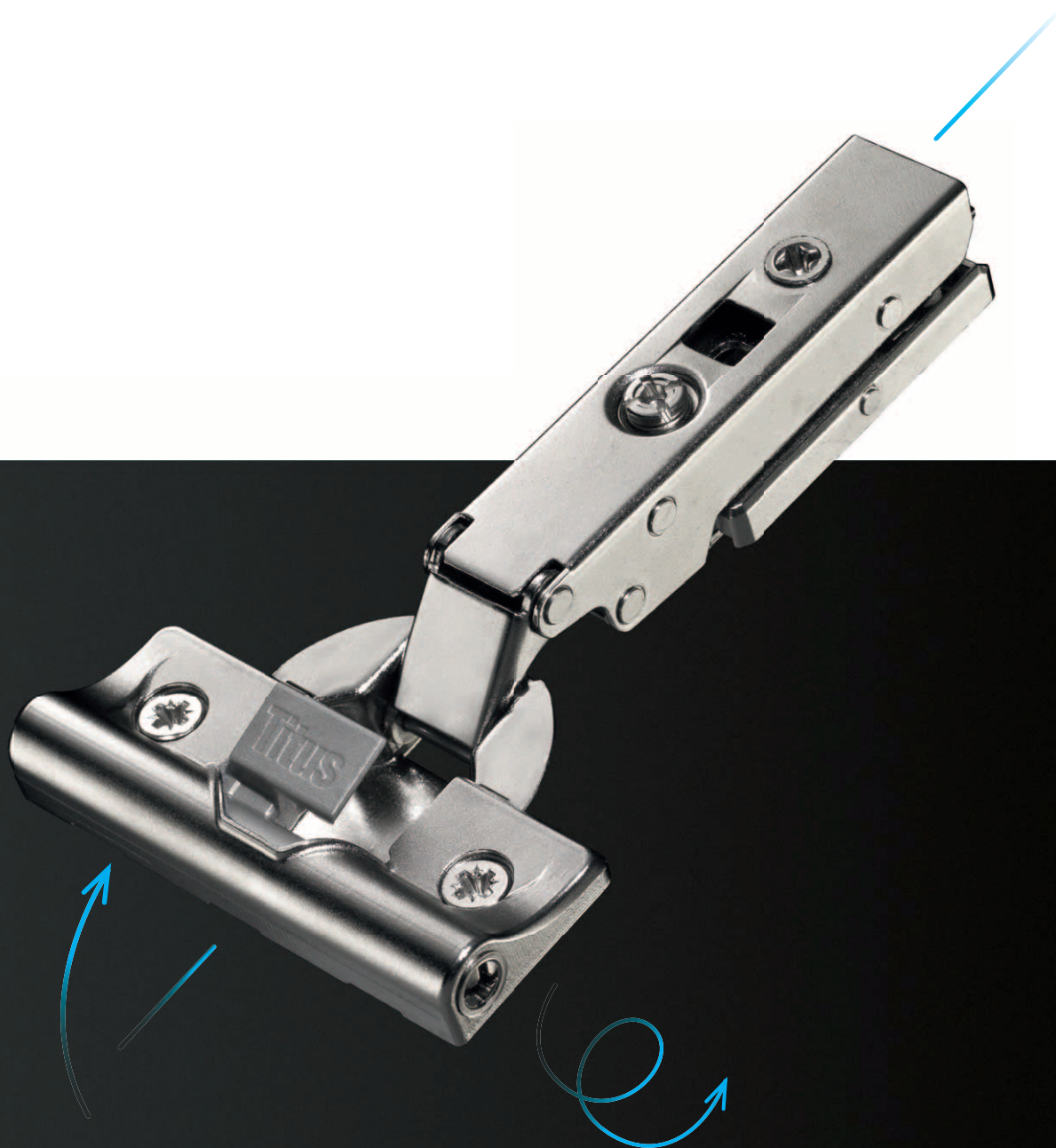

Adjustable damping

- Consistent performance on doors of different dimensions and weights
- Intuitive adjustment procedure



'Titus Damper Inside'

- Titus proprietary multi-purpose damping technology
- Reliable and consistent life-long damping
- No rebound



Proven Glissando concept

- Damper is positioned transversal on the hinge cup
- Reliable performance

T-type Glissando 110

For wood doors

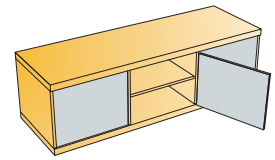
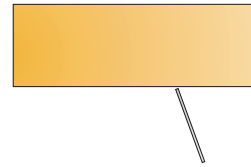
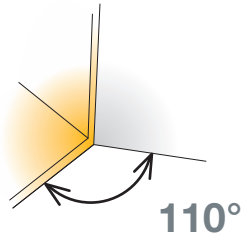

- Opening angle
- Drilling diameter for hinge cup
- Drilling depth
- Hinge on plate mounting system

110°
35mm
11.7mm
'3Way' snap-on



Technical details

Cup type	Interaxis 45mm	Interaxis 48mm
	Item number	Item number

Cranking
0mm

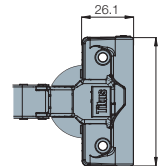
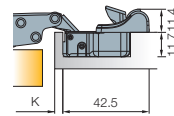
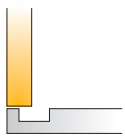

	701-0AT0-054	701-0AS0-054
	701-0AT1-054	701-0AS1-054
	701-0AT4-054	701-0AS4-054

Drilling patterns for hinge cups → see page 3.15

150 Pcs Made of steel

Cranking
5mm

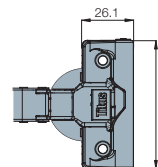
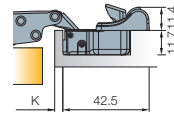

	701-0BT0-054	701-0BS0-054
	701-0BT1-054	701-0BS1-054
	701-0BT4-054	701-0BS4-054

Drilling patterns for hinge cups → see page 3.15

150 Pcs Made of steel

Mounting plates



Cam adjustable cruciform mounting plate
→ see page 3.51



Cruciform mounting plate
→ see page 3.53



Cam adjustable horizontal mounting plate
→ see page 3.51



Face frame adapter plate
→ see page 3.53

Hinge cup screws

If not pre-mounted

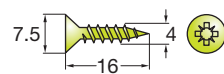

820-6328-050

10000 Pcs

Accessories



Cover caps for hinge arm
→ see page 3.151

Legend of hinge cup symbols

Screw-on ready
← screws

Machine insertion ready

Easy-fix system

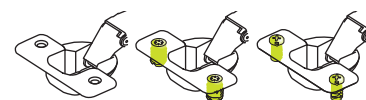

Damping adjustment

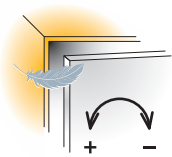

Door adjustment

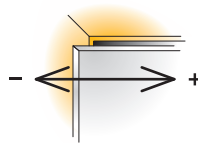

Side adjustment
+3/-1mm

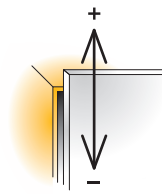

Height adjustment
+2/-2mm

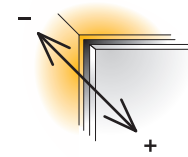

Depth adjustment
+4/1mm

For further explanation → see page 3.25

For further explanation → see pages 3.20-3.23

Mounting details

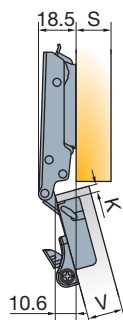

Drawing show application on D=0mm thick mounting plate

Mounting plate drilling distance

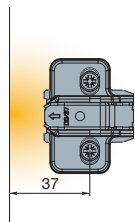
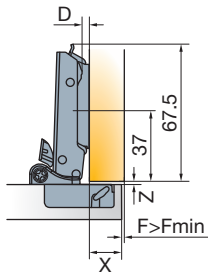

Mounting plate thickness table

For further explanation → see page 3.11

x	13	14	15	16	17	18	19
3	3	2	1	0			
4	4	3	2	1	0		
K							
5		4	3	2	1	0	
6			4	3	2	1	0
							D

$D=13+K-x$

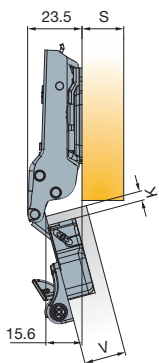

Drawing show application on D=0mm thick mounting plate

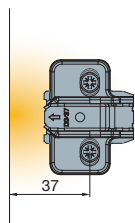
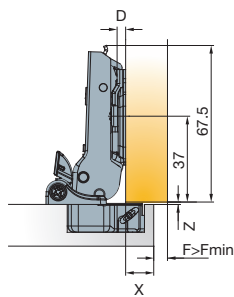

x	8	9	10	11	12	13	14
3	3	2	1	0			
4	4	3	2	1	0		
K							
5		4	3	2	1	0	
6			4	3	2	1	0
							D

$D=8+K-x$

Door clearance at R=1mm

For further explanation → see page 3.12

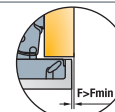

V	16	17	18	19	20	21	22	23	24	25	26
3	0.5	0.7	0.8	1	1.2	1.5	1.7	2.1	2.8	4.1	5.5
4	0.4	0.7	0.8	1	1.2	1.5	1.7	2.1	2.3	3.1	4.5
K											
5	0.4	0.6	0.7	0.9	1.1	1.4	1.6	2	2.2	2.6	3.5
6	0.4	0.6	0.7	0.9	1.1	1.4	1.6	2	2.2	2.6	2.9
											F _{MIN}

Gap Z_{MIN}=0

T-type Glissando 110

For wood doors

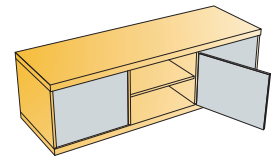
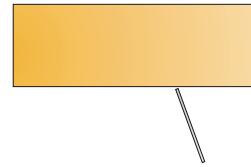
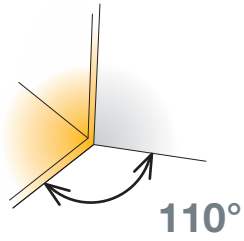

- Opening angle
- Drilling diameter for hinge cup
- Drilling depth
- Hinge on plate mounting system

- 110°
- 35mm
- 11.7mm
- '3Way' snap-on



Technical details

Cup type	Interaxis 45mm	Interaxis 48mm
	Item number	Item number

Cranking
9mm

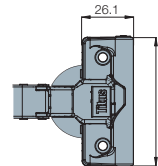
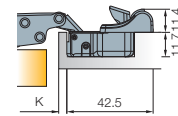
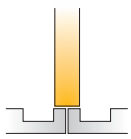

	701-OCT0-054	701-OCS0-054
	701-OCT1-054	701-OCS1-054
	701-OCT4-054	701-OCS4-054

Drilling patterns for hinge cups → see page 3.15

150 Pcs

Made of steel

Cranking
17mm

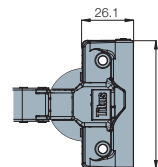
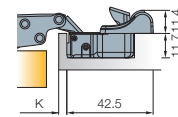
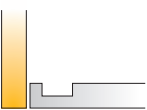

	701-ODT0-054	701-ODS0-054
	701-ODT1-054	701-ODS1-054
	701-ODT4-054	701-ODS4-054

Drilling patterns for hinge cups → see page 3.15

150 Pcs

Made of steel

Mounting plates



Cam adjustable cruciform mounting plate
→ see page 3.51



Cruciform mounting plate
→ see page 3.53



Cam adjustable horizontal mounting plate
→ see page 3.51



Face frame adapter plate
→ see page 3.53

Hinge cup screws

If not pre-mounted

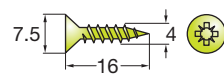

820-6328-050

10000 Pcs

Accessories



Cover caps for hinge arm
→ see page 3.151

Legend of hinge cup symbols

Screw-on ready
← screws

Machine insertion ready

Easy-fix system

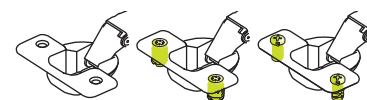

Damping adjustment

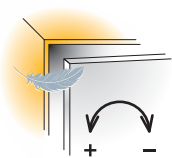

Door adjustment

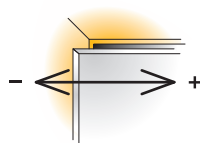

Side adjustment
+3/-1mm

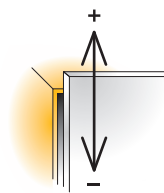

Height adjustment
+2/-2mm

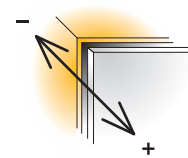

Depth adjustment
+4/-1mm

For further explanation → see page 3.25

For further explanation → see pages 3.20-3.23

Mounting details

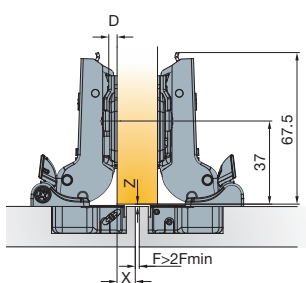
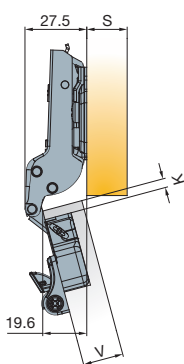

Mounting plate drilling distance

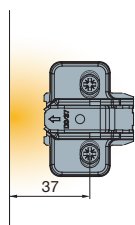

Mounting plate thickness table

For further explanation → see page 3.11

x	4	5	6	7	8	9	10
3	3	2	1	0			
4	4	3	2	1	0		
K							
5		4	3	2	1	0	
6			4	3	2	1	0
							D

$D=4+K-x$

Drawing show application on D=0mm thick mounting plate

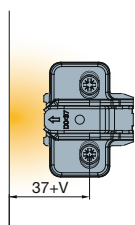
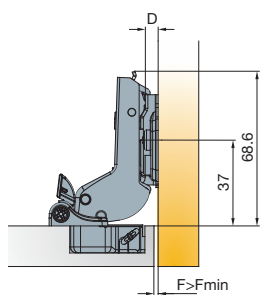
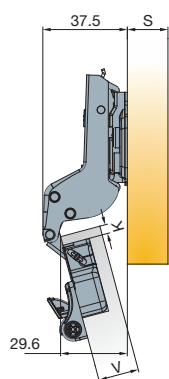

V

V	16	17	18	19	20	21	22	23	24
3	0	0	0	0	1	1	1	1	2
4	1	1	1	1	2	2	2	2	3
K									
5	2	2	2	2	3	3	3	3	4
6	3	3	3	3	4	4	4	4	
									D

$D=-4+K+F$

Drawing show application on D=2mm thick mounting plate

Door clearance at R=1mm

For further explanation → see page 3.12

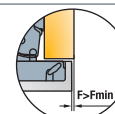

V	16	17	18	19	20	21	22	23	24	25	26
3	0.5	0.7	0.8	1	1.2	1.5	1.7	2.1	2.8	4.1	5.5
4	0.4	0.7	0.8	1	1.2	1.5	1.7	2.1	2.3	3.1	4.5
K											
5	0.4	0.6	0.7	0.9	1.1	1.4	1.6	2	2.2	2.6	3.5
6	0.4	0.6	0.7	0.9	1.1	1.4	1.6	2	2.2	2.6	2.9
											F _{MIN}

Gap Z_{MIN}=0

T-type Glissando 120

For wood doors

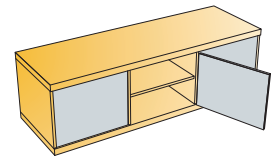
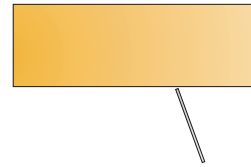
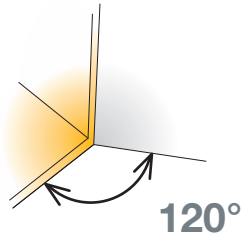

- Opening angle
- Drilling diameter for hinge cup
- Drilling depth
- Hinge on plate mounting system

- 120°
- 35mm
- 11.9mm
- '3Way' snap-on



Technical details

Cup type	Interaxis 45mm	Interaxis 48mm
	Item number	Item number

Cranking
0mm

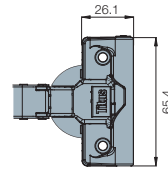
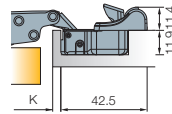

	701-OUT0-054	701-OUS0-054
	701-OUT1-054	701-OUS1-054
	701-OUT4-054	701-OUS4-054

Drilling patterns for hinge cups → see page 3.15

150 Pcs

Made of steel

Cranking
9mm

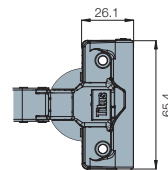
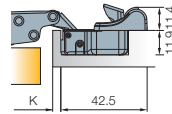
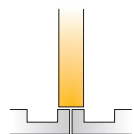

	701-OVT0-054	701-OVS0-054
	701-OVT1-054	701-OVS1-054
	701-OVT4-054	701-OVS4-054

Drilling patterns for hinge cups → see page 3.15

150 Pcs

Made of steel

Mounting plates



Cam adjustable cruciform mounting plate
→ see page 3.51



Cruciform mounting plate
→ see page 3.53



Cam adjustable horizontal mounting plate
→ see page 3.51



Face frame adapter plate
→ see page 3.53

Hinge cup screws

If not pre-mounted

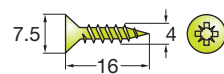

820-6328-050

10000 Pcs

Accessories



Cover caps for hinge arm
→ see page 3.151

Legend of hinge cup symbols

Screw-on ready
← screws

Machine insertion ready

Easy-fix system

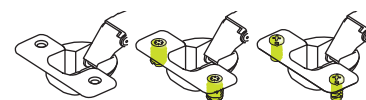

Damping adjustment

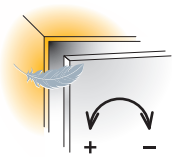

Door adjustment

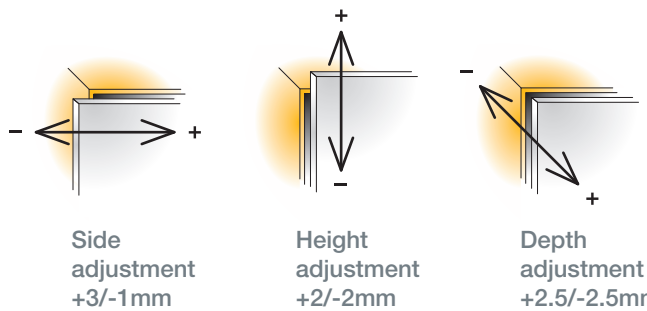

For further explanation → see page 3.25

For further explanation → see pages 3.20-3.23

Mounting details

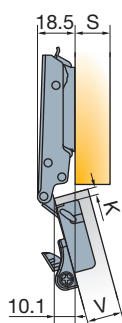

Drawing show application on D=0mm thick mounting plate

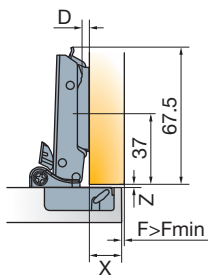

Mounting plate drilling distance

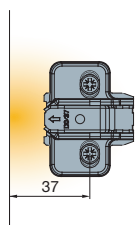

Mounting plate thickness table

For further explanation → see page 3.11

x	13	14	15	16	17	18	19
3	3	2	1	0			
4	4	3	2	1	0		
K		4	3	2	1	0	
5			4	3	2	1	0
6				4	3	2	1
							0
							D

$D=13+K-x$

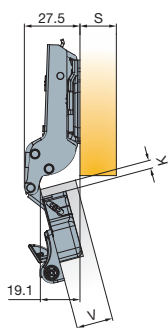

Drawing show application on D=0mm thick mounting plate

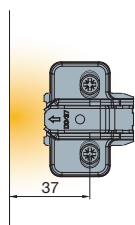
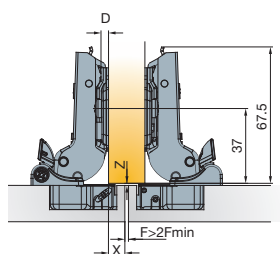

x	4	5	6	7	8	9	10
3	3	2	1	0			
4	4	3	2	1	0		
K		4	3	2	1	0	
5			4	3	2	1	0
6				4	3	2	1
							0
							D

$D=4+K-x$

Door clearance at R=1mm

For further explanation → see page 3.12

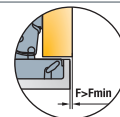

V	16	17	18	19
3	1.1	0.4	0	0
K	4	2	1.4	0.7
	5	3	2.3	1
				F _{MIN}

Gap Z_{MIN} =2

T-type Glissando 110/45°

45° angled application for wood doors

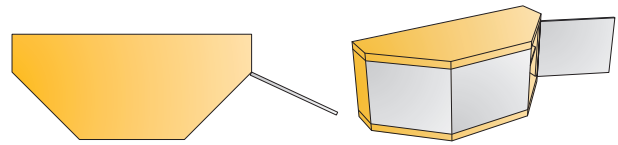

- Opening angle 110°
- Drilling diameter for hinge cup 35mm
- Drilling depth 11.7mm
- Hinge on plate mounting system '3Way' snap-on



Technical details

Cup type	Interaxis 45mm	Interaxis 48mm
	<p>Ø 35</p>	<p>Ø 35</p>
Item number	701-0B08-054	701-0B10-054
Item number	701-0C78-054	701-0C80-054
Item number	701-0C54-054	701-0C56-054

Drilling patterns for hinge cups → see page 3.15

Cranking
17mm

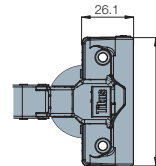
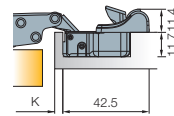
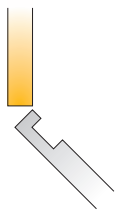

150 Pcs

Cup made of steel, arm made of zinc

Mounting plates



Cam adjustable cruciform mounting plate
→ see page 3.51



Cruciform mounting plate
→ see page 3.53



Cam adjustable horizontal mounting plate
→ see page 3.51



Face frame adapter plate
→ see page 3.53

Hinge cup screws

If not pre-mounted

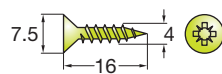

820-6328-050

10000 Pcs

Accessories



Cover caps for hinge arm
→ see page 3.151

Legend of hinge cup symbols

Screw-on ready
← screws

Machine insertion ready

Easy-fix system

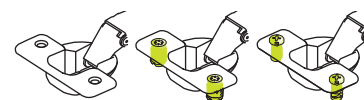

Damping adjustment

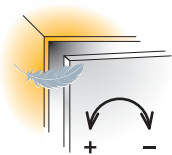

Door adjustment

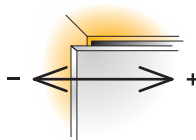

Side adjustment
+3/-1mm

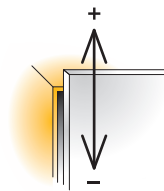

Height adjustment
+2/-2mm

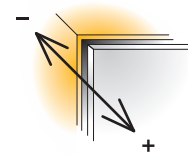

Depth adjustment
+2.5/-2.5mm

For further explanation → see page 3.25

For further explanation → see pages 3.20-3.23

Mounting details

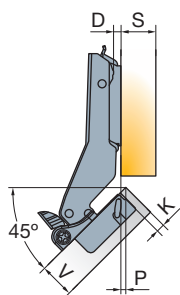
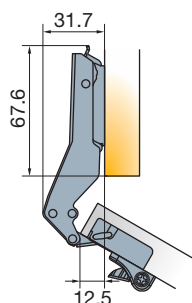

Mounting plate drilling distance

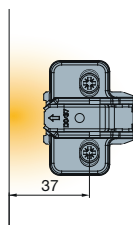

Mounting plate thickness table

For further explanation → see page 3.11

P	0	0.5	1	1.5	2	2.5	3	3.5	4
3		2		1		0			
4	3		2		1		0		
5		3		2		1		0	
6	4		3		2		1		0

Drawings show application on D=0mm thick mounting plate

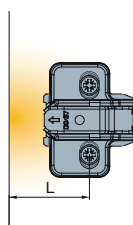
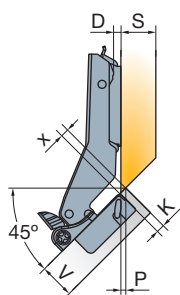
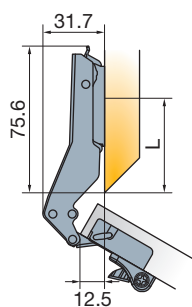

X	0	0.5	1	1.5	2	2.5	3	3.5	4	4.5	5	6
3	2			1			0					
4			2			1			0			
5		3			2			1			0	
6	4			3			2			1		0

Drawings show application on D=0mm thick mounting plate

L=45 for thickness D=0
L=44 for thickness D=1
L=43 for thickness D=2
L=42 for thickness D=3
L=41 for thickness D=4

Door clearance at R=1mm

For further explanation → see page 3.12

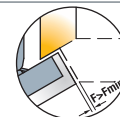

V	16	17	18	19	20	21	22	23	24	25	26
3	0.5	0.7	0.8	1	1.2	1.5	1.7	2.1	2.8	4.1	5.5
4	0.4	0.7	0.8	1	1.2	1.5	1.7	2.1	2.3	3.1	4.5
5	0.4	0.6	0.7	0.9	1.1	1.4	1.6	2	2.2	2.6	3.5
6	0.4	0.6	0.7	0.9	1.1	1.4	1.6	2	2.2	2.6	2.9

Gap Z_{MIN}=0

T-type Glissando 110/90°

For wood door cabinets with blind panels

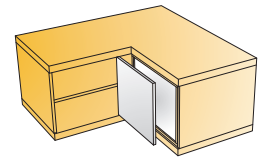

- Opening angle 110°
- Drilling diameter for hinge cup 35mm
- Drilling depth 11.7mm
- Hinge on plate mounting system '3Way' snap-on



Technical details

Cup type	Interaxis 45mm	Interaxis 48mm
Item number	Item number	Item number
	701-0A96-054	701-0A98-054
	701-0D36-054	701-0D38-054
	701-0D30-054	701-0D32-054

Drilling patterns for hinge cups → see page 3.15

Cranking
17mm

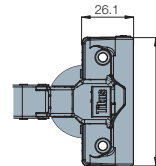
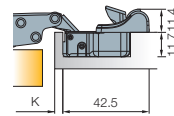

150 Pcs

Cup made of steel, arm made of zinc

Mounting plates



Cam adjustable cruciform mounting plate
→ see page 3.51



Cruciform mounting plate
→ see page 3.53



Cam adjustable horizontal mounting plate
→ see page 3.51



Face frame adapter plate
→ see page 3.53

Hinge cup screws

If not pre-mounted

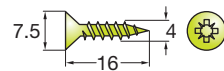

820-6328-050

10000 Pcs

Accessories



Cover caps for hinge arm
→ see page 3.151

Legend of hinge cup symbols

Screw-on ready
← screws

Machine insertion ready

Easy-fix system



Damping adjustment

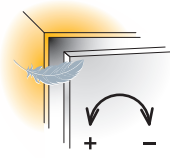

Door adjustment

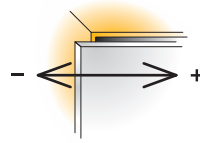

Side adjustment
+3/-1mm

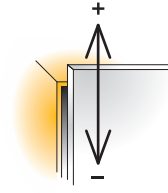

Height adjustment
+2/-2mm

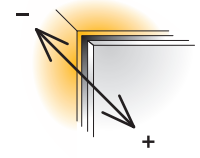

Depth adjustment
+2.5/-2.5mm

For further explanation → see page 3.25

For further explanation → see pages 3.20-3.23

Mounting details

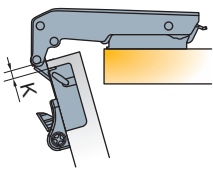

Drawings show application on D=2mm thick mounting plate

Mounting plate drilling distance

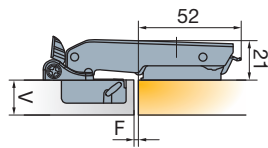

Drawings show application on D=2mm thick mounting plate

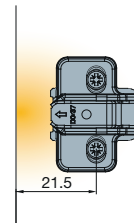

Door clearance at R=1mm

For further explanation → see page 3.12

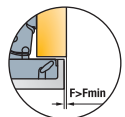

V	16	17	18	19	20	21	22	23	24	25	26	
K	3	0.5	0.7	0.8	1	1.2	1.5	1.7	2.1	2.8	4.1	5.5
	4	0.4	0.7	0.8	1	1.2	1.5	1.7	2.1	2.3	3.1	4.5
	5	0.4	0.6	0.7	0.9	1.1	1.4	1.6	2	2.2	2.6	3.5
	6	0.4	0.6	0.7	0.9	1.1	1.4	1.6	2	2.2	2.6	2.9 F _{MIN}

Gap Z_{MIN}=0

T-type 110

For wood doors

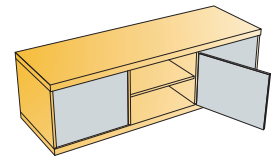
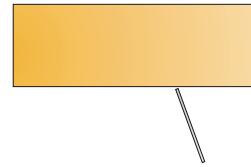
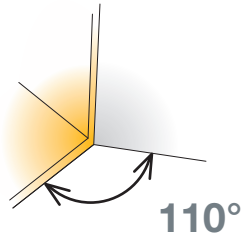

- Opening angle
- Drilling diameter for hinge cup
- Drilling depth
- Hinge on plate mounting system

110°
35mm
11.7mm
'3Way' snap-on



Technical details

Cup type	Interaxis 45mm	Interaxis 48mm
Item number	Item number	Item number

Cranking
0mm

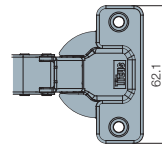
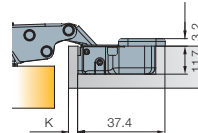

	702-0AK0-054	702-0AL0-054
	702-0AK1-054	702-0AL1-054
	702-0AK4-054	702-0AL4-054

Drilling patterns for hinge cups → see page 3.15

150 Pcs

Made of steel

Cranking
5mm

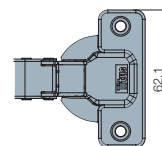
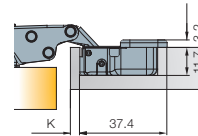
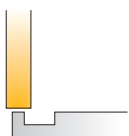

	702-0BK0-054	702-0BL0-054
	702-0BK1-054	702-0BL1-054
	702-0BK4-054	702-0BL4-054

Drilling patterns for hinge cups → see page 3.15

150 Pcs

Made of steel

Mounting plates



Cam adjustable cruciform mounting plate
→ see page 3.51



Cruciform mounting plate
→ see page 3.53



Cam adjustable horizontal mounting plate
→ see page 3.51



Face frame adapter plate
→ see page 3.53

Hinge cup screws If not pre-mounted

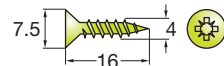

820-6328-050

10000 Pcs

Accessories



Cover caps for hinge arm
→ see page 3.151



Push latch
→ see page 3.149

Legend of hinge cup symbols

Screw-on ready
← screws

Machine insertion ready

Easy-fix system

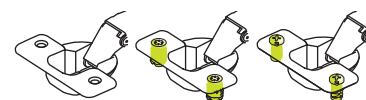

Door adjustment

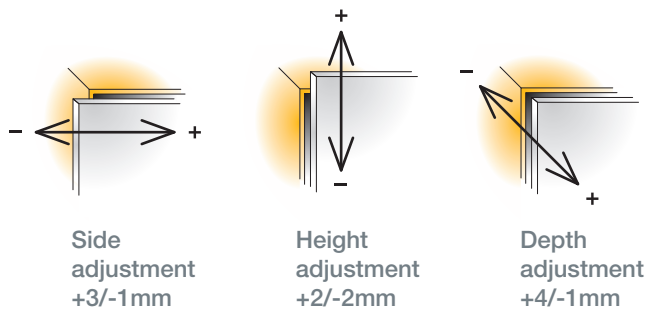

For further explanation → see pages 3.20-3.23

Mounting details

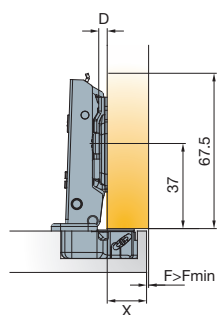
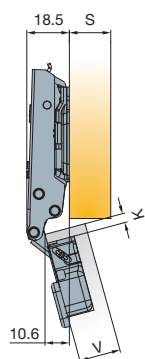

Drawing show application on D=0mm thick mounting plate

Mounting plate drilling distance

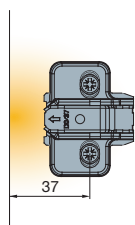

Mounting plate thickness table

For further explanation → see page 3.11

x	13	14	15	16	17	18	19
3	3	2	1	0			
4	4	3	2	1	0		
K							
5		4	3	2	1	0	
6			4	3	2	1	0
							D

$D=13+K-x$

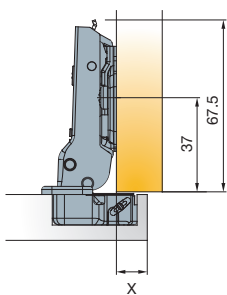
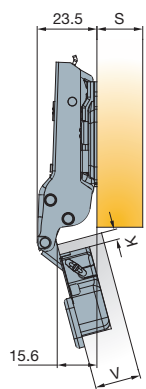

Drawing show application on D=0mm thick mounting plate

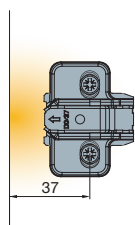

x	8	9	10	11	12	13	14
3	3	2	1	0			
4	4	3	2	1	0		
K							
5		4	3	2	1	0	
6			4	3	2	1	0
							D

$D=8+K-x$

Soft closing systems



Glissando TL
→ see page 2.15



Glissando CR
→ see page 2.19

Door clearance at R=1mm

For further explanation → see page 3.12

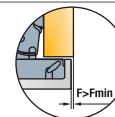

V	16	17	18	19	20	21	22	23	24	25	26
3	0.5	0.7	0.8	1	1.2	1.5	1.7	2.1	2.8	4.1	5.5
4	0.4	0.7	0.8	1	1.2	1.5	1.7	2.1	2.3	3.1	4.5
K											
5	0.4	0.6	0.7	0.9	1.1	1.4	1.6	2	2.2	2.6	3.5
6	0.4	0.6	0.7	0.9	1.1	1.4	1.6	2	2.2	2.6	2.9
											F _{MIN}

Gap Z_{MIN}=0

T-type 110

For wood doors

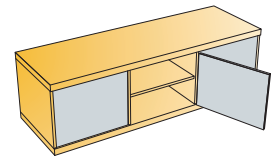
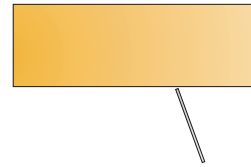
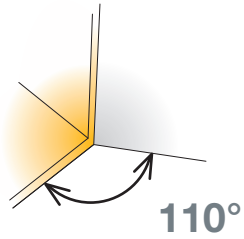

- Opening angle
- Drilling diameter for hinge cup
- Drilling depth
- Hinge on plate mounting system

110°
35mm
11.7mm
'3Way' snap-on

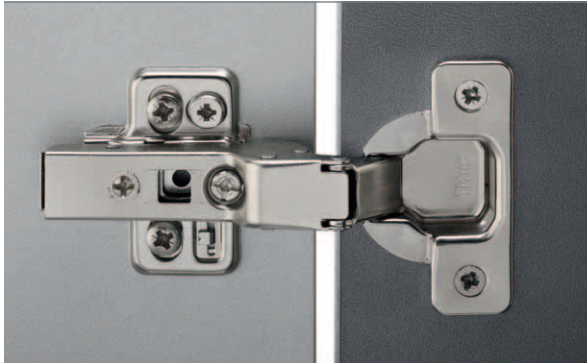

Technical details

Cup type	Interaxis 45mm	Interaxis 48mm
Item number		

Cranking
9mm

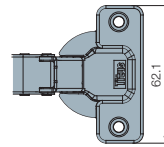
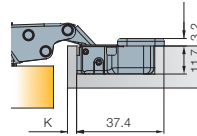
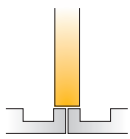

	702-0CK0-054	702-0CL0-054
	702-0CK1-054	702-0CL1-054
	702-0CK4-054	702-0CL4-054

Drilling patterns for hinge cups → see page 3.15

150 Pcs

Made of steel

Cranking
17mm

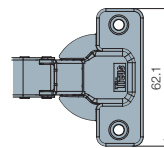
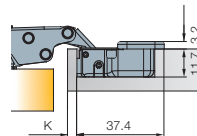
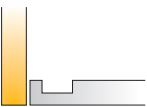

	702-0DK0-054	702-0DL0-054
	702-0DK1-054	702-0DL1-054
	702-0DK4-054	702-0DL4-054

Drilling patterns for hinge cups → see page 3.15

150 Pcs

Made of steel

Mounting plates



Cam adjustable cruciform mounting plate
→ see page 3.51



Cruciform mounting plate
→ see page 3.53



Cam adjustable horizontal mounting plate
→ see page 3.51



Face frame adapter plate
→ see page 3.53

Hinge cup screws

If not pre-mounted

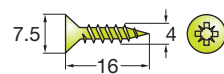

820-6328-050

10000 Pcs

Accessories



Cover caps for hinge arm
→ see page 3.151



Push latch
→ see page 3.149

Legend of hinge cup symbols

Screw-on ready
← screws

Machine insertion ready

Easy-fix system

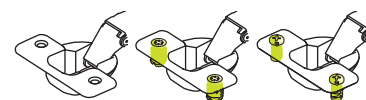

Door adjustment

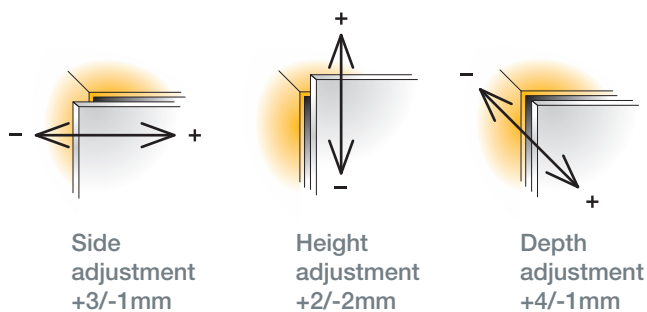

For further explanation → see pages 3.20-3.23

Mounting details

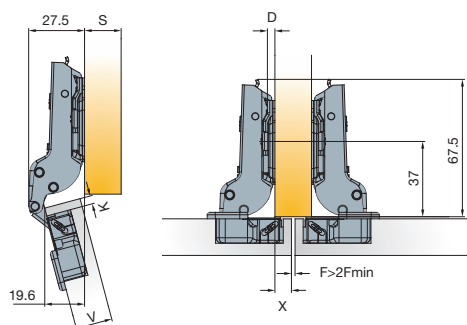

Drawing show application on D=0mm thick mounting plate

Mounting plate drilling distance

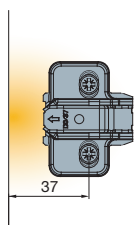

Mounting plate thickness table

For further explanation → see page 3.11

x	4	5	6	7	8	9	10
3	3	2	1	0			
4	4	3	2	1	0		
K							
5		4	3	2	1	0	
6			4	3	2	1	0
							D

$D=4+K-x$

V 16 17 18 19 20 21 22 23 24

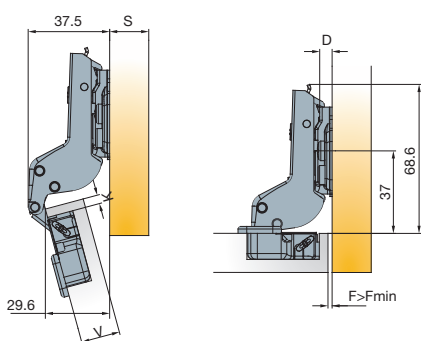

Drawing show application on D=2mm thick mounting plate

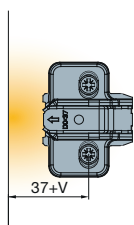

3	0	0	0	0	1	1	1	1	2
4	1	1	1	1	2	2	2	2	3
K									
5	2	2	2	2	3	3	3	3	4
6	3	3	3	3	4	4	4	4	D

$D=-4+K+F$

Soft closing systems



Glissando TL
→ see page 2.15



Glissando CR
→ see page 2.19

Door clearance at R=1mm

For further explanation → see page 3.12

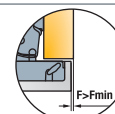

V	16	17	18	19	20	21	22	23	24	25	26
3	0.5	0.7	0.8	1	1.2	1.5	1.7	2.1	2.8	4.1	5.5
4	0.4	0.7	0.8	1	1.2	1.5	1.7	2.1	2.3	3.1	4.5
K											
5	0.4	0.6	0.7	0.9	1.1	1.4	1.6	2	2.2	2.6	3.5
6	0.4	0.6	0.7	0.9	1.1	1.4	1.6	2	2.2	2.6	2.9
											F _{MIN}

Gap Z_{MIN}=0

T-type 120

For wood doors

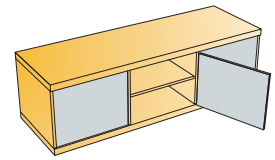
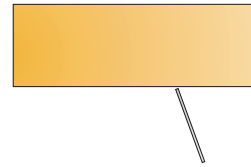
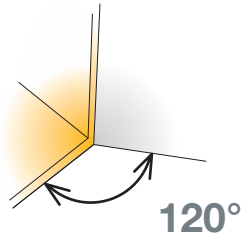

- Opening angle
- Drilling diameter for hinge cup
- Drilling depth
- Hinge on plate mounting system

120°
35mm
11.9mm
'3Way' snap-on



Technical details

Cup type	Interaxis 45mm	Interaxis 48mm
	Item number	Item number

Cranking
0mm

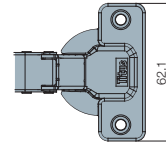
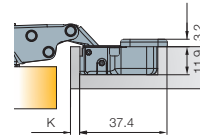

	702-0UK0-054	702-0UL0-054
	702-0UK1-054	702-0UL1-054
	702-0UK4-054	702-0UL4-054

Drilling patterns for hinge cups → see page 3.15

150 Pcs

Made of steel

Cranking
9mm

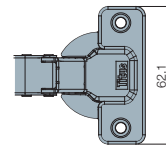
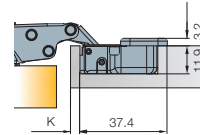
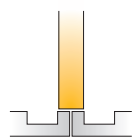

	702-0VK0-054	702-0VL0-054
	702-0VK1-054	702-0VL1-054
	702-0VK4-054	702-0VL4-054

Drilling patterns for hinge cups → see page 3.15

150 Pcs

Made of steel

Mounting plates



Cam adjustable cruciform mounting plate
→ see page 3.51



Cruciform mounting plate
→ see page 3.53



Cam adjustable horizontal mounting plate
→ see page 3.51



Face frame adapter plate
→ see page 3.53

Hinge cup screws

If not pre-mounted

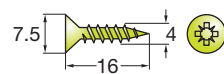

820-6328-050

10000 Pcs

Accessories



Cover caps for hinge arm
→ see page 3.151



Push latch
→ see page 3.149

Legend of hinge cup symbols

Screw-on ready
← screws

Machine insertion ready

Easy-fix system

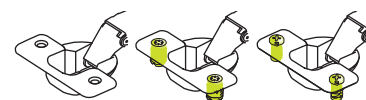

Door adjustment

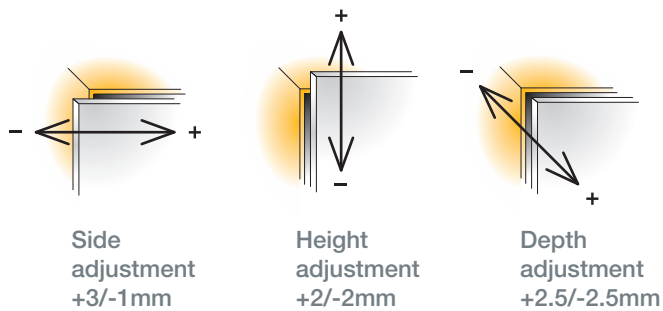

For further explanation → see pages 3.20-3.23

Mounting details

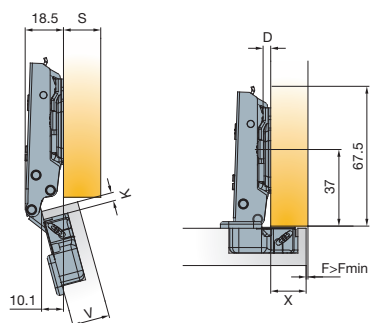

Drawing show application on D=0mm thick mounting plate

Mounting plate drilling distance

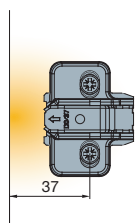

Mounting plate thickness table

For further explanation → see page 3.11

x	13	14	15	16	17	18	19
3	3	2	1	0			
4	4	3	2	1	0		
K							
5		4	3	2	1	0	
6			4	3	2	1	0
							D

$D=13+K-x$

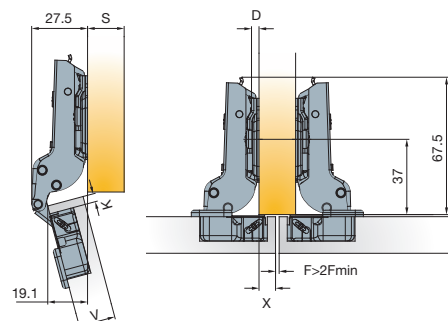

Drawing show application on D=0mm thick mounting plate

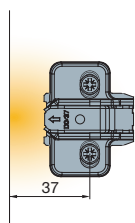

x	4	5	6	7	8	9	10
3	3	2	1	0			
4	4	3	2	1	0		
K							
5		4	3	2	1	0	
6			4	3	2	1	0
							D

$D=4+K-x$

Soft closing systems



Glissando CR
→ see page 2.19

Door clearance at R=1mm

For further explanation → see page 3.12

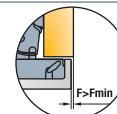

V	16	17	18	19
3	1.1	0.4	0	0
K				
4	2	1.4	0.7	0.1
5	3	2.3	1.6	1
				F _{MIN}

Gap Z_{MIN} =2

T-type 110/45°

45° angled application for wood doors

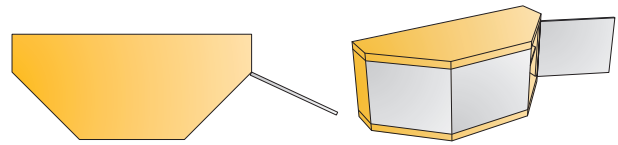

- Opening angle 110°
- Drilling diameter for hinge cup 35mm
- Drilling depth 11.7mm
- Hinge on plate mounting system '3Way' snap-on



Technical details

	Interaxis 45mm	Interaxis 48mm
Cup type	Item number	Item number
	702-0B07-054	702-0B09-054
	702-0C53-054	702-0C55-054
	702-0C77-054	702-0C79-054

Cranking
17mm

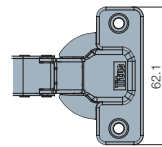
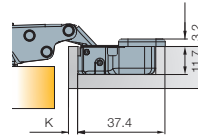
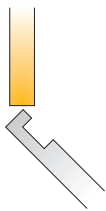

Drilling patterns for hinge cups → see page 3.15

150 Pcs

Cup made of steel, arm made of zinc

Mounting plates



Cam adjustable cruciform mounting plate
→ see page 3.51



Cruciform mounting plate
→ see page 3.53



Cam adjustable horizontal mounting plate
→ see page 3.51



Face frame adapter plate
→ see page 3.53

Hinge cup screws

If not pre-mounted

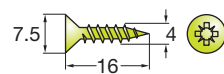

820-6328-050

10000 Pcs

Accessories



Cover caps for hinge arm
→ see page 3.151

Legend of hinge cup symbols

Screw-on ready
← screws

Machine insertion ready

Easy-fix system



Door adjustment

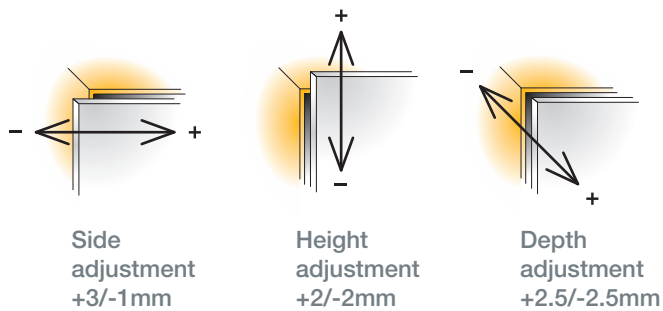

For further explanation → see pages 3.20-3.23

Mounting details

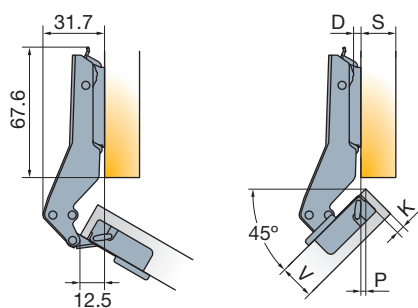

Drawings show application on D=0mm thick mounting plate

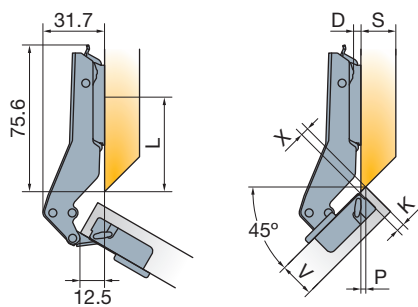

Drawings show application on D=0mm thick mounting plate

Mounting plate drilling distance

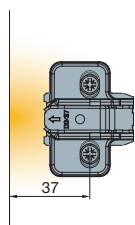

Mounting plate thickness table

For further explanation → see page 3.11

P	0	0.5	1	1.5	2	2.5	3	3.5	4
3		2		1		0			
4	3		2		1		0		
5		3		2		1		0	
6	4		3		2		1		0

X

X	0	0.5	1	1.5	2	2.5	3	3.5	4	4.5	5	6
3	2			1			0					
4			2			1			0			
5		3			2			1			0	
6	4			3			2			1		0

L=45 for thickness D=0
 L=44 for thickness D=1
 L=43 for thickness D=2
 L=42 for thickness D=3
 L=41 for thickness D=4

Soft closing systems



Glissando TL
 → see page 2.15

Door clearance at R=1mm

For further explanation → see page 3.12

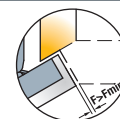

V	16	17	18	19	20	21	22	23	24	25	26
3	0.5	0.7	0.8	1	1.2	1.5	1.7	2.1	2.8	4.1	5.5
4	0.4	0.7	0.8	1	1.2	1.5	1.7	2.1	2.3	3.1	4.5
5	0.4	0.6	0.7	0.9	1.1	1.4	1.6	2	2.2	2.6	3.5
6	0.4	0.6	0.7	0.9	1.1	1.4	1.6	2	2.2	2.6	2.9

Gap Z_{MIN}=0

T-type 110/90°

For wood door cabinets with blind panels

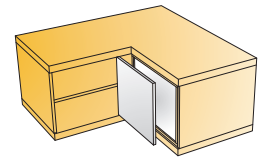
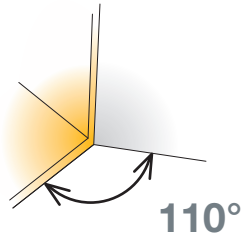

- Opening angle 110°
- Drilling diameter for hinge cup 35mm
- Drilling depth 11.7mm
- Hinge on plate mounting system '3Way' snap-on



Technical details

Cup type	Interaxis 45mm	Interaxis 48mm
Item number	Item number	Item number
	702-0A95-054	702-0A97-054
	702-0D29-054	702-0D31-054
	702-0D35-054	702-0D37-054

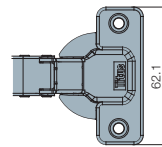
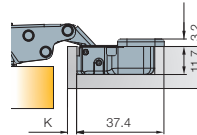
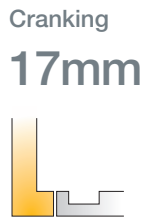

Drilling patterns for hinge cups → see page 3.15



150 Pcs

Cup made of steel, arm made of zinc

Mounting plates



Cam adjustable cruciform mounting plate
→ see page 3.51



Cruciform mounting plate
→ see page 3.53



Cam adjustable horizontal mounting plate
→ see page 3.51



Face frame adapter plate
→ see page 3.53

Hinge cup screws

If not pre-mounted

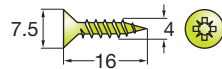

820-6328-050



10000 Pcs

Accessories



Cover caps for hinge arm
→ see page 3.151

Legend of hinge cup symbols



Screw-on ready
← screws



Machine insertion ready



Easy-fix system

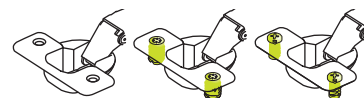

Door adjustment

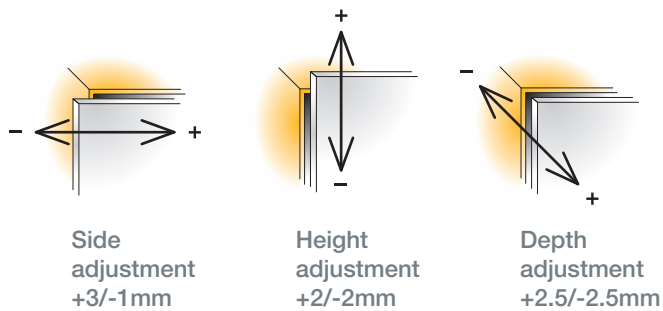

For further explanation → see pages 3.20-3.23

Mounting details

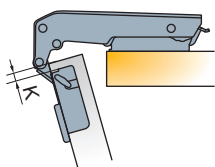

Drawings show application on D=2mm thick mounting plate

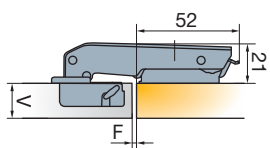

Drawings show application on D=2mm thick mounting plate

Mounting plate drilling distance

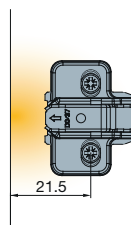

Soft closing systems



Glissando TL
→ see page 2.15

Door clearance at R=1mm

For further explanation → see page 3.12

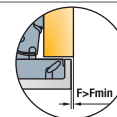

V	16	17	18	19	20	21	22	23	24	25	26	
K	3	0.5	0.7	0.8	1	1.2	1.5	1.7	2.1	2.8	4.1	5.5
	4	0.4	0.7	0.8	1	1.2	1.5	1.7	2.1	2.3	3.1	4.5
	5	0.4	0.6	0.7	0.9	1.1	1.4	1.6	2	2.2	2.6	3.5
	6	0.4	0.6	0.7	0.9	1.1	1.4	1.6	2	2.2	2.6	2.9 F _{MIN}

Gap Z_{MIN}=0

T-type 170

For wood doors

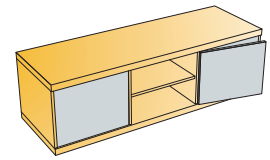
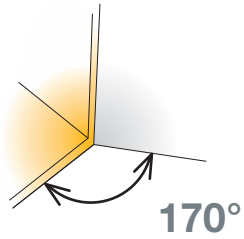

- Opening angle
- Drilling diameter for hinge cup
- Drilling depth
- Hinge on plate mounting system

165°
35mm
12mm
'3Way' snap-on

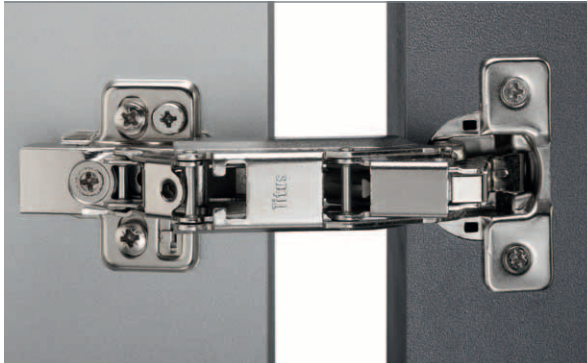

Cup type	Interaxis 45mm	Interaxis 48mm
	Item number	Item number

Cranking
0mm

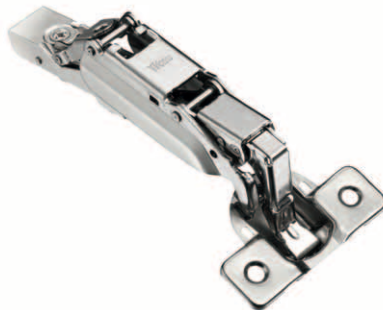

	702-0EK0-054	702-0EL0-054
	702-0EK1-054	702-0EL1-054
	702-0EK4-054	702-0EL4-054

Drilling patterns for hinge cups → see page 3.15

50 Pcs

Made of steel and zinc

Cranking
5mm

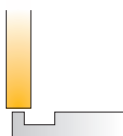

	702-0FK0-054	702-0FL0-054
	702-0FK1-054	702-0FL1-054
	702-0FK4-054	702-0FL4-054

Drilling patterns for hinge cups → see page 3.15

50 Pcs

Made of steel and zinc

Mounting plates



Cam adjustable cruciform mounting plate
→ see page 3.51



Cruciform mounting plate
→ see page 3.53



Cam adjustable horizontal mounting plate
→ see page 3.51



Face frame adapter plate
→ see page 3.53

Hinge cup screws

If not pre-mounted

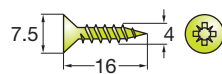

820-6328-050

10000 Pcs

Accessories



Push latch
→ see page 3.149

Legend of hinge cup symbols

Screw-on ready
← screws

Machine insertion ready

Easy-fix system

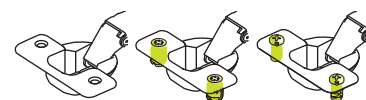

Door adjustment

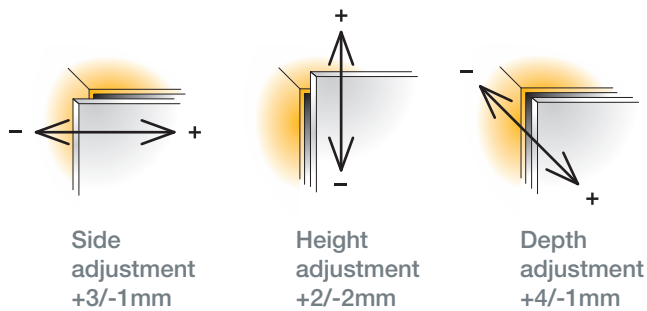

For further explanation → see pages 3.20-3.23

Mounting details

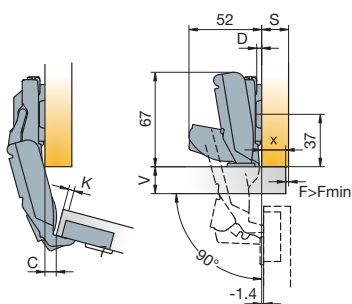

Drawings show application on D=0mm mounting plate
In 90° position the door is only 1.4mm distant from side panel

Mounting plate drilling distance

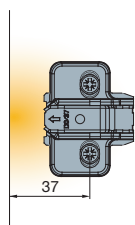

Mounting plate thickness table

For further explanation → see page 3.11

x	13	14	15	16	17	18	19
3	3	2	1	0			
4	4	3	2	1	0		
K							
5		4	3	2	1	0	
6			4	3	2	1	0
							D

$D=13+K-x$

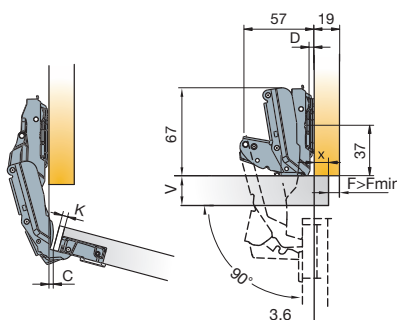

Drawings show application on D=0mm mounting plate

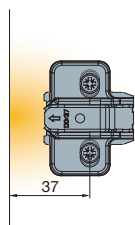

x	8	9	10	11	12	13	14
3	3	2	1	0			
4	4	3	2	1	0		
K							
5		4	3	2	1	0	
6			4	3	2	1	0
							D

$D=8+K-x$

Soft closing systems



Glissando TL 170
→ see page 2.17



Glissando CR
→ see page 2.19

Door clearance at R=1mm

For further explanation → see page 3.12

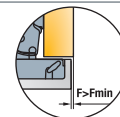

V	16	17	18	19	20	21	22	23	24
3	0.0	0.0	0.0	0.0	0.0	0.0	0.0	0.0	0.0
4	0.0	0.0	0.0	0.0	0.0	0.0	0.0	0.0	0.0
K									
5	0.0	0.0	0.0	0.0	0.0	0.0	0.0	0.0	0.0
6	0.0	0.0	0.0	0.0	0.0	0.0	0.0	0.0	2.6
7	0.0	0.0	0.0	0.0	0.0	0.0	0.0	0.0	5.1

Gap Z_{MIN}=0.5

T-type 170

For wood doors

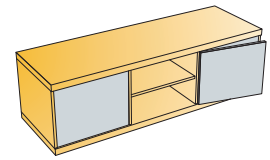
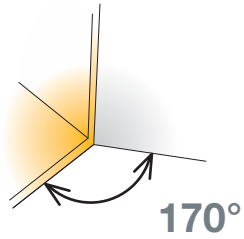

- Opening angle
- Drilling diameter for hinge cup
- Drilling depth
- Hinge on plate mounting system

165°
35mm
12mm
'3Way' snap-on



Cranking
9mm

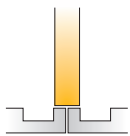

	Interaxis 45mm	Interaxis 48mm
Cup type	Item number	Item number
	702-0GK0-054	702-0GL0-054
	702-0GK1-054	702-0GL1-054
	702-0GK4-054	702-0GL4-054

Drilling patterns for hinge cups → see page 3.15

50 Pcs

Made of steel and zinc

Mounting plates



Cam adjustable cruciform mounting plate
→ see page 3.51



Cruciform mounting plate
→ see page 3.53



Cam adjustable horizontal mounting plate
→ see page 3.51



Face frame adapter plate
→ see page 3.53

Hinge cup screws

If not pre-mounted

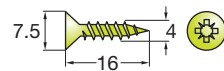

820-6328-050

10000 Pcs

Accessories



Push latch
→ see page 3.149

Legend of hinge cup symbols

Screw-on ready
← screws

Machine insertion ready

Easy-fix system

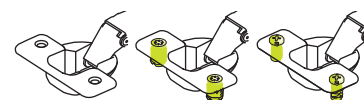

Door adjustment

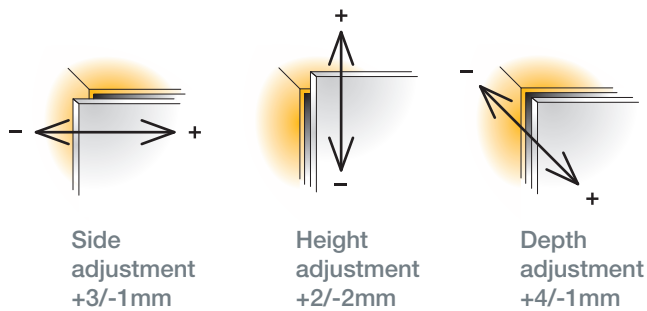

For further explanation → see pages 3.20-3.23

Mounting details

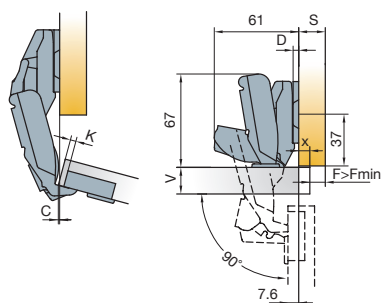

Drawings show application on D=0mm thick mounting plate

Mounting plate drilling distance

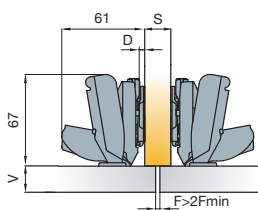

Drawings show application on D=0mm thick mounting plate

Mounting plate thickness table

For further explanation → see page 3.11

x	13	14	15	16	17	18	19
K	3	3	2	1	0		
	4	4	3	2	1	0	
	5		4	3	2	1	0
	6			4	3	2	1

$D=13+K-x$

Soft closing systems



Glissando TL 170
→ see page 2.17



Glissando CR
→ see page 2.19

Door clearance at R=1mm

For further explanation → see page 3.12

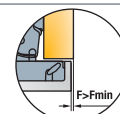

V	16	17	18	19	20	21	22	23	24
3	0.0	0.0	0.0	0.0	0.0	0.0	0.0	0.0	0.0
	0.0	0.0	0.0	0.0	0.0	0.0	0.0	0.0	0.0
K 5	0.0	0.0	0.0	0.0	0.0	0.0	0.0	0.0	0.0
	0.0	0.0	0.0	0.0	0.0	0.0	0.0	0.0	2.6
7	0.0	0.0	0.0	0.0	0.0	0.0	0.0	0.0	5.1

Gap Z_{MIN}=0.5

T-type Mounting Plates

'3Way' snap-on mounting

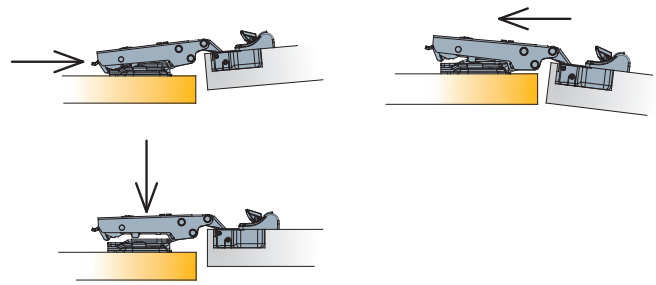

Cam adjustable cruciform
mounting plate 37mm

Drilling pattern

Dimensions

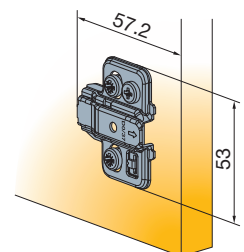
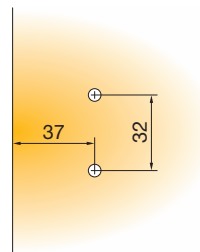

150 Pcs Made of steel

Cam adjustable horizontal
mounting plate

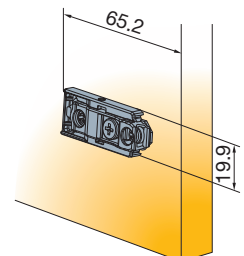
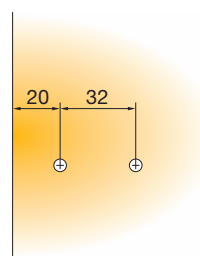

150 Pcs Made of steel and zinc



Mounting plate thickness

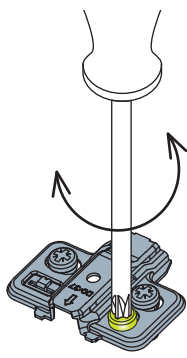

Height adjustment +2/-2mm

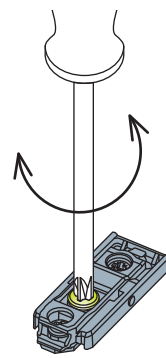

Height adjustment +2/-2mm

Mounting plate type	15		10.5	15	14.5	
Mounting plate thickness (D)				no pre-drilling required 		
Item number						
0mm	700-0KC0-054	700-0KB0-054	700-0KF0-054	700-0KA0-054	700-0KE0-054	
1mm	700-0KC1-054	700-0KB1-054	700-0KF1-054	700-0KA1-054	700-0KE1-054	
2mm	700-0KC2-054	700-0KB2-054	700-0KF2-054	700-0KA2-054	700-0KE2-054	
3mm	700-0KC3-054	700-0KB3-054	700-0KF3-054	700-0KA3-054	700-0KE3-054	
4mm	700-0KC4-054	700-0KB4-054	700-0KF4-054	700-0KA4-054	700-0KE4-054	
0mm	700-0LC0-650	700-0LB0-650	700-0LF0-650			
2mm	700-0LC2-650	700-0LB2-650	700-0LF2-650			
3mm	700-0LC3-650	700-0LB3-650	700-0LF3-650			

Legend of mounting plate type symbols



Pre-mounted 15mm euro screws



Machine insertion ready



Pre-mounted 10.5mm expanding dowels



Premounted chipboard screw



Premounted chipboard screw

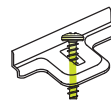
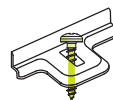
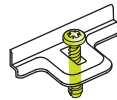
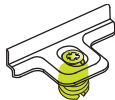

T-type Mounting Plates

'3Way' snap-on mounting

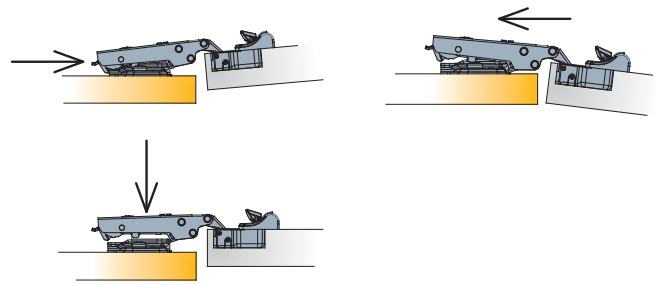

Cruciform mounting plate 37mm

Drilling pattern

Dimensions

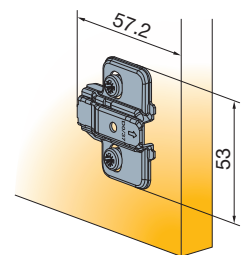
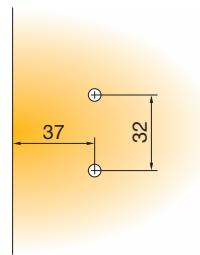

 150 Pcs Made of steel

Face frame mounting plate

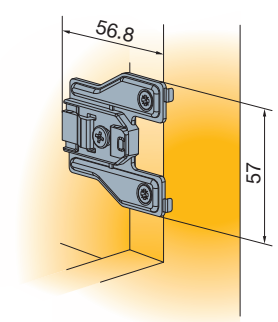
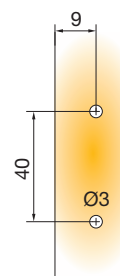

 150 Pcs Made of steel and zinc

Fixing screw for cruciform mounting plate
If not pre-mounted

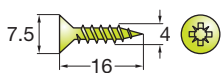

Chipboard screws
820-6328-050

 10000 Pcs



Mounting plate thickness

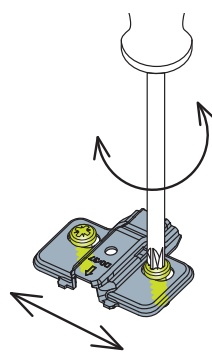



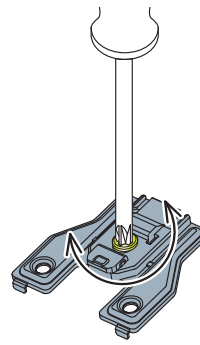









Height adjustment +/-2mm



Height adjustment +/-2mm

Mounting plate type		 15		 10.5	 15	 14.5	
Mounting plate thickness (D)					no pre-drilling required 		
Item number	Item number	Item number	Item number	Item number	Item number	Item number	Item number
0mm	700-0NA0-054	700-0NC0-054	700-0NB0-054	700-0NF0-054	700-0NR0-054	700-0NE0-054	
1mm	700-0NA1-054	700-0NC1-054	700-0NB1-054	700-0NF1-054	700-0NR1-054	700-0NE1-054	
2mm	700-0NA2-054	700-0NC2-054	700-0NB2-054	700-0NF2-054	700-0NR2-054	700-0NE2-054	
3mm	700-0NA3-054	700-0NC3-054	700-0NB3-054	700-0NF3-054	700-0NR3-054	700-0NE3-054	
4mm	700-0NA4-054	700-0NC4-054	700-0NB4-054	700-0NF4-054	700-0NR4-054	700-0NE4-054	
0mm							700-0NW0-054
3mm							700-0NW3-054

Legend of mounting plate type symbols

	 15		 10.5	 15	 14.5
Screw-on ready for chipboard screws ← screws	Pre-mounted 15mm euro screws	Machine insertion ready	Pre-mounted 10.5mm expanding dowels	Premounted chipboard screw	Premounted chipboard screw
					

S-type Hinges

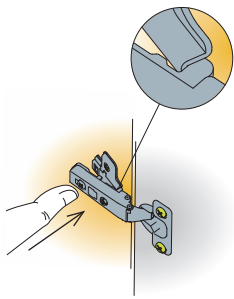

'Snap-on' mounting system

- Easy and quick assembly and disassembly
- Flexibility for the furniture user
- Tight hinge-to-plate joint improves hinge stability and reduces door sag

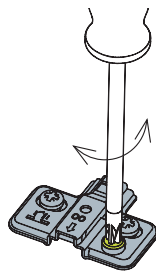

Easily accesible height adjustment with cam

- Intuitive and quick height adjustment
- Consumer friendly

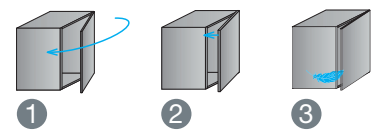

'ConfidentClose'

- 1 Fast closing
- 2 Late start of deceleration action
- 3 Quiet landing with 'SoftTouch'

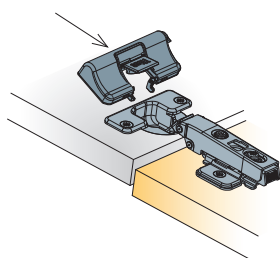

Soft closing options

- Hinge integrated
- Add-on with Glissando ready hinge cup
- Stand-alone



Adjustable damping

- Adjustable damping assures perfect functioning on every door

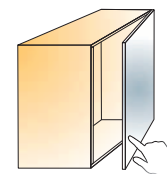

Touch opening

- Guarantees effortless opening
- Elegant cabinet design
- Doors without handles

S-type-i Plus 110

For wood doors

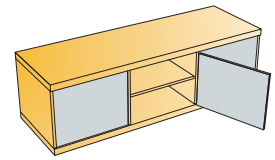
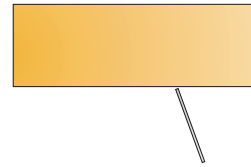

- Opening angle
- Drilling diameter for hinge cup
- Drilling depth
- Hinge on plate mounting system

110°
35mm
min. 11mm
'snap-on'



Technical details

Cup type	Interaxis 45mm	Interaxis 48mm
Item number		

Cranking
0mm

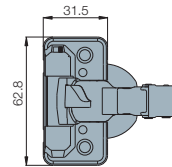
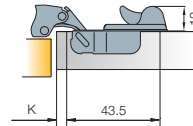

200 Pcs

Made of steel and plastic

	954-0228-050	954-0229-050
--	--------------	--------------

Drilling patterns for hinge cups → see page 3.15

Cranking
9mm

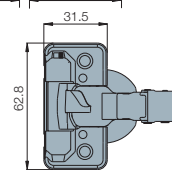
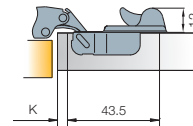
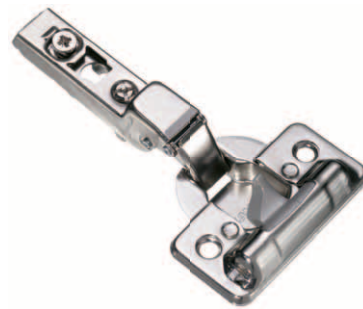
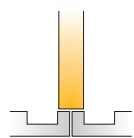

200 Pcs

Made of steel and plastic

	954-0E16-050	954-0E17-050
--	--------------	--------------

Drilling patterns for hinge cups → see page 3.15

Mounting plates



Cam adjustable mounting plate
→ see page 3.97



Steel mounting plates
→ see page 3.99



Zinc diecast mounting plates
→ see page 3.99



Face frame adapters
→ see page 3.101

Hinge cup screws

If not pre-mounted

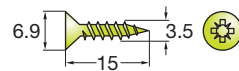

820-6308-050

10000 Pcs

Accessories



Cover caps for hinge arm
→ see page 3.151

Legend of hinge cup symbols

Screw-on ready
← screws



Damping adjustment

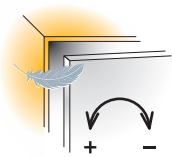

For further explanation → see page 3.25

Door adjustment

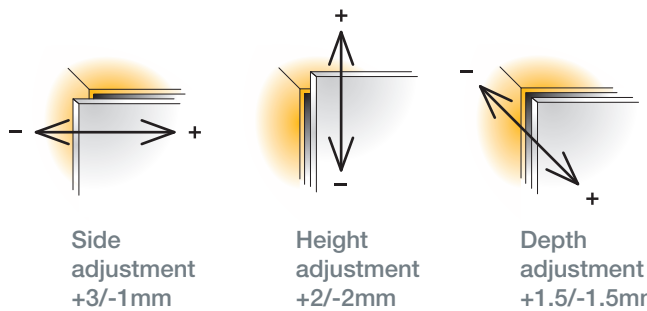

For further explanation → see pages 3.20-3.23

Mounting details

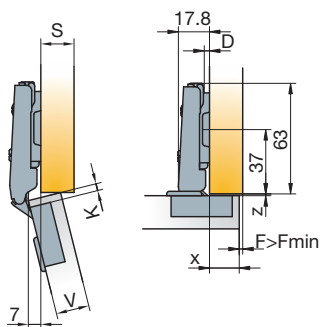

Mounting plate drilling distance

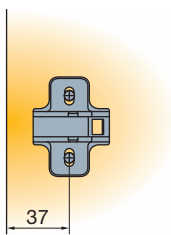

Mounting plate thickness table

For further explanation → see page 3.11

x	13	14	15	16	17	18
3	3	2	1	0		
K 4		3	2	1	0	
5			3	2	1	0

$D=13+K-x$

Drawings show application on D=0mm thick mounting plate

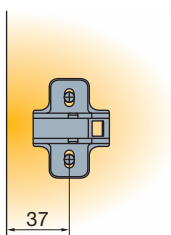
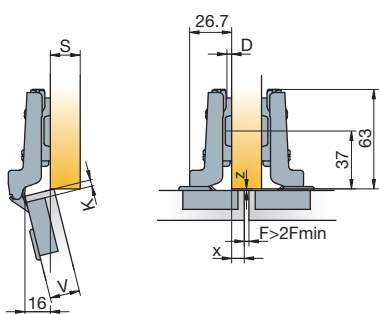

x	4	5	6	7	8	9
3	3	2	1	0		
K 4		3	2	1	0	
5			3	2	1	0

$D=4+K-x$

Drawings show application on D=0mm thick mounting plate

Door clearance

For further explanation → see page 3.12

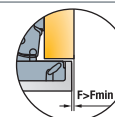

V	16	17	18	19	20	21	22
3	0.3	0.5	0.7	1.0	1.3	1.7	2.5
K 4	0.3	0.5	0.7	0.9	1.2	1.6	2.1
5	0.3	0.5	0.7	0.9	1.2	1.5	2.0

Gap $Z_{MIN}=0$

S-type-i 110

For wood doors

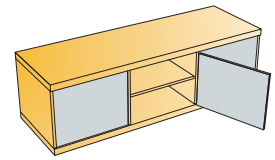
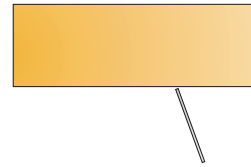

- Opening angle
- Drilling diameter for hinge cup
- Drilling depth
- Hinge on plate mounting system

110°
35mm
min. 11mm
'snap-on'



Technical details

Cup type	Interaxis 45mm	Interaxis 48mm
	Item number	Item number

Cranking
0mm

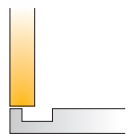

200 Pcs



Made of steel and plastic

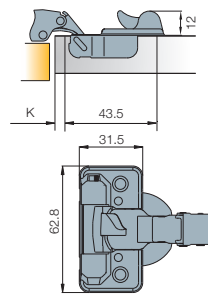

	954-0226-050	954-0227-050
Drilling patterns for hinge cups → see page 3.15		

Cranking
9mm

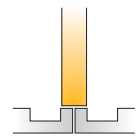

200 Pcs



Made of steel and plastic

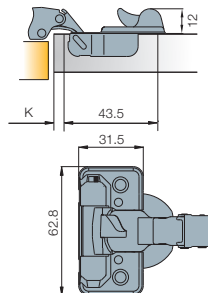

	954-0230-050	954-0U81-050
Drilling patterns for hinge cups → see page 3.15		

Cranking
15mm

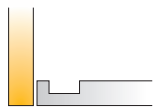

200 Pcs



Made of steel and plastic

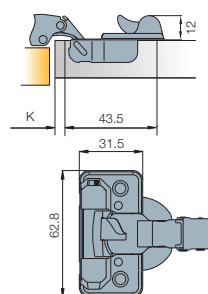

	954-0E05-050	954-0E13-050
Drilling patterns for hinge cups → see page 3.15		

Mounting plates



Cam adjustable mounting plate
→ see page 3.97



Steel mounting plates
→ see page 3.99



Zinc diecast mounting plates
→ see page 3.99



Face frame adapters
→ see page 3.101

Hinge cup screws

If not pre-mounted

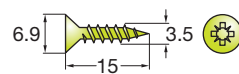

820-6308-050

10000 Pcs

Accessories



Cover caps for hinge arm
→ see page 3.151

Legend of hinge cup symbols

Screw-on ready
← screws



Damping adjustment

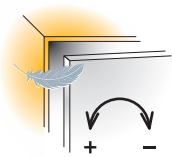

Door adjustment

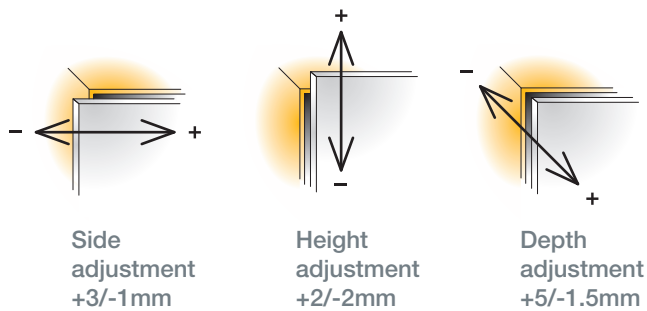

For further explanation → see page 3.25

For further explanation → see pages 3.20-3.23

Mounting details

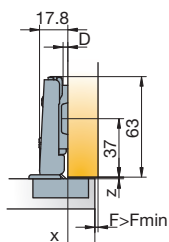
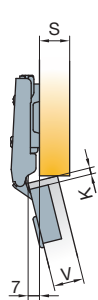

Drawings show application on D=0mm thick mounting plate

Mounting plate drilling distance

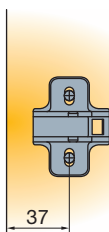

Mounting plate thickness table

For further explanation → see page 3.11

x	13	14	15	16	17	18
3	3	2	1	0		
K	4	3	2	1	0	
5			3	2	1	0

$D=13+K-x$

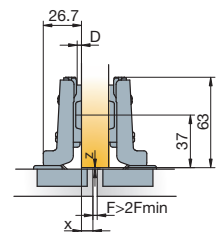
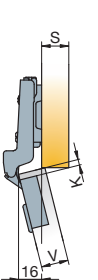

Drawings show application on D=0mm thick mounting plate

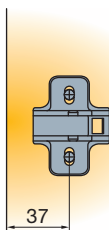

x	4	5	6	7	8	9
3	3	2	1	0		
K	4	3	2	1	0	
5			3	2	1	0

$D=4+K-x$

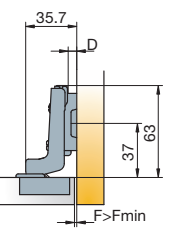
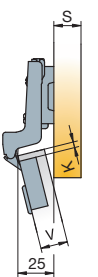

Drawings show application on D=3mm thick mounting plate

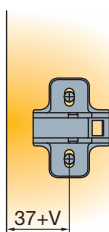

V	16	17	18	19	20	21
3	2	2	2	3	3	3
K	4	3	3	3		
5	3					

$D=-2+K+F$

Door clearance

For further explanation → see page 3.12

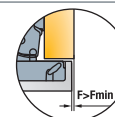

V	16	17	18	19	20	21	22
3	0.3	0.5	0.7	1.0	1.3	1.7	2.5
K	4	0.3	0.5	0.7	0.9	1.2	1.6
5	0.3	0.5	0.7	0.9	1.2	1.5	2.0

Gap $Z_{MIN}=0$

S-type-i 110/30°

30° angled application for wood doors

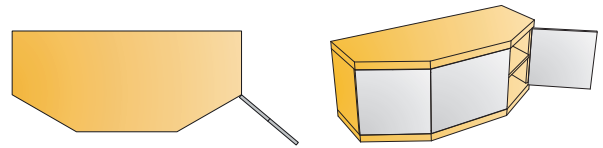
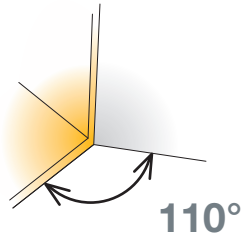

- Opening angle
- Drilling diameter for hinge cup
- Drilling depth
- Hinge on plate mounting system

110°
35mm
min. 11mm
'snap-on'



Technical details

	Interaxis 45mm	Interaxis 48mm
Cup type		
Item number	954-0E09-650	954-0164-650

Cranking
9mm

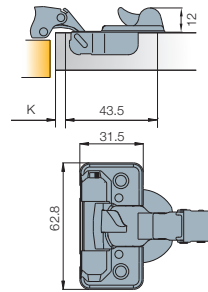
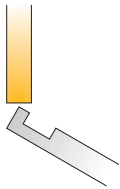

Drilling patterns for hinge cups → see page 3.15

100 Pcs

Cup made of steel and plastic, arm made of zinc

Mounting plates



Cam adjustable mounting plate
→ see page 3.97



Steel mounting plates
→ see page 3.99



Zinc diecast mounting plates
→ see page 3.99

Hinge cup screws

If not pre-mounted

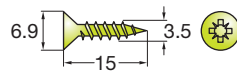

820-6308-050

10000 Pcs

Accessories



Cover caps for hinge arm
→ see page 3.151

Legend of hinge cup symbols

Screw-on ready
← screws



Damping adjustment

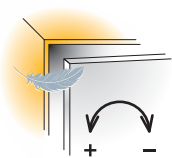

Door adjustment

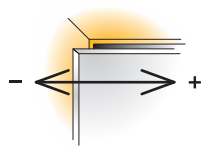

Side adjustment
+3/-1mm

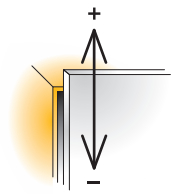

Height adjustment
+2/-2mm

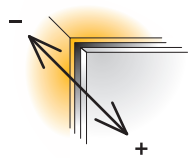

Depth adjustment
+5/-1.5mm

For further explanation → see page 3.25

For further explanation → see pages 3.20-3.23

Mounting details

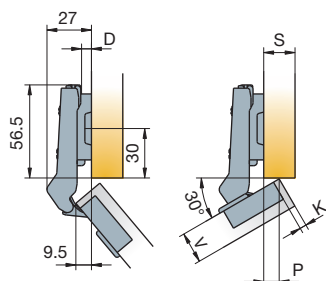

Mounting plate drilling distance

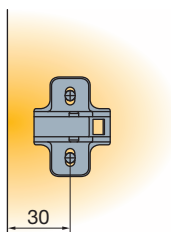

Mounting plate thickness table

For further explanation → see page 3.11

P	2.5	3.5	4.5	8.5	9.5	10.5	11.5	12.5	13.5
3	9			3	2	1	0		
K 4		9			3	2	1	0	
5			9			3	2	1	0 D

Drawings show application on D=3mm thick mounting plate

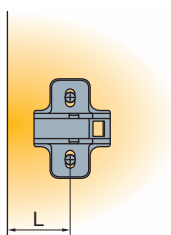
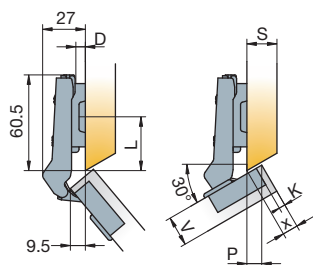

x	2	3	4	9	10	11	12	13	14	15
3	9			3	2			0		
K 4		9			3	2			0	
5			9			3	2			0 D

Drawings show application on D=3mm thick mounting plate

L=37 for thickness D=0
L=36 for thickness D=1
L=35 for thickness D=2
L=34 for thickness D=3
L=31 for thickness D=9

Door clearance

For further explanation → see page 3.12

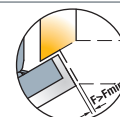

V	16	17	18	19	20	21	22
3	0.3	0.5	0.7	1.0	1.3	1.7	2.5
K 4	0.3	0.5	0.7	0.9	1.2	1.6	2.1
5	0.3	0.5	0.7	0.9	1.2	1.5	2.0 F _{MIN}

Gap Z_{MIN}=0

S-type-i 110/45°

45° angled application for wood doors

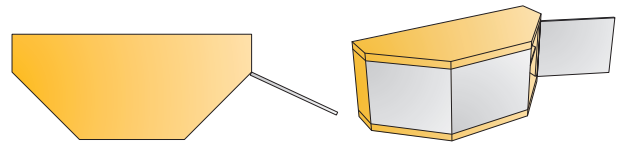
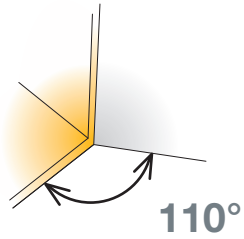

- Opening angle
- Drilling diameter for hinge cup
- Drilling depth
- Hinge on plate mounting system

110°
35mm
min. 11mm
'snap-on'



Technical details

	Interaxis 45mm	Interaxis 48mm
Cup type		
Item number	954-0E10-650	954-0165-650

Cranking
9mm

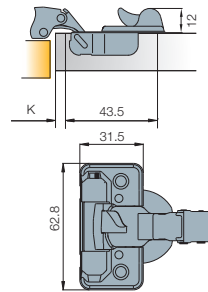
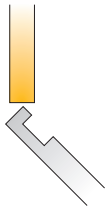

Drilling patterns for hinge cups → see page 3.15

100 Pcs

Cup made of steel and plastic, arm made of zinc

Mounting plates



Cam adjustable mounting plate
→ see page 3.97



Steel mounting plates
→ see page 3.99



Zinc diecast mounting plates
→ see page 3.99

Hinge cup screws

If not pre-mounted

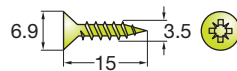

820-6308-050

10000 Pcs

Accessories



Cover caps for hinge arm
→ see page 3.151

Legend of hinge cup symbols

Screw-on ready
← screws



Damping adjustment

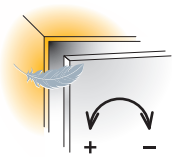

Door adjustment

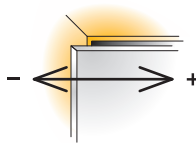

Side adjustment
+3/-1mm

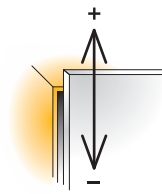

Height adjustment
+2/-2mm

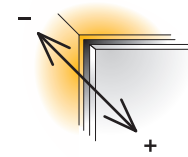

Depth adjustment
+5/-1.5mm

For further explanation → see page 3.25

For further explanation → see pages 3.20-3.23

Mounting details

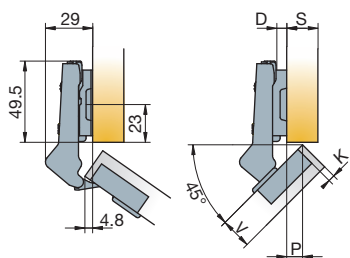

Mounting plate drilling distance

Mounting plate thickness table
For further explanation → see page 3.11

P	9	9.5	10	10.5	11	11.5	12	12.5	13.5
3	3		2		1		0		
K 4		3		2		1		0	
5				3		2		1	0 D

Drawings show application on D=3mm thick mounting plate

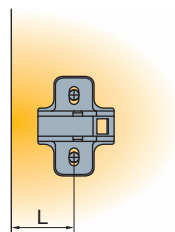
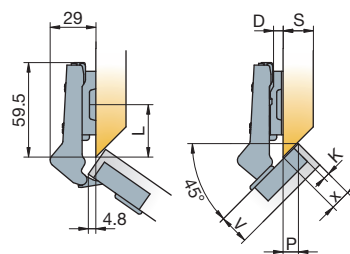

x	11.5	12.5	13	13.5	14	14.5	15	15.5	16	16.5	17	18
3	3		2			1			0			
K 4		3			2			1			0	
5					3			2		1		0 D

Drawings show application on D=3mm thick mounting plate

L=36 for thickness D=0
L=35 for thickness D=1
L=34 for thickness D=2
L=33 for thickness D=3

Door clearance

For further explanation → see page 3.12

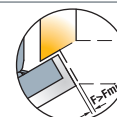

V	16	17	18	19	20	21	22
3	0.3	0.5	0.7	1.0	1.3	1.7	2.5
K 4	0.3	0.5	0.7	0.9	1.2	1.6	2.1
5	0.3	0.5	0.7	0.9	1.2	1.5	2.0 F _{MIN}

Gap Z_{MIN}=0

S-type-i 110/45°

45° angled application for wood doors

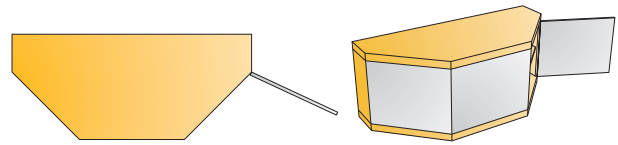
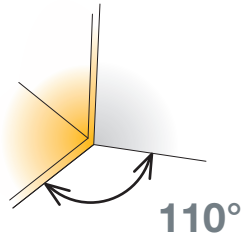

- Opening angle
 - Drilling diameter for hinge cup
 - Drilling depth
 - Hinge on plate mounting system
- 110°
35mm
min. 11mm
'snap-on'



Technical details

	Interaxis 45mm	Interaxis 48mm
Cup type		
Item number		

Cranking
18mm

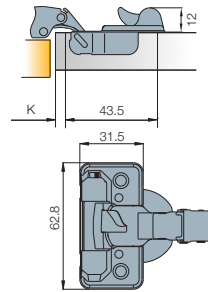
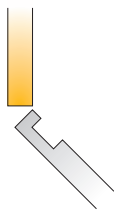

Item number	954-0E11-650	954-0E14-650
-------------	--------------	--------------

Drilling patterns for hinge cups → see page 3.15

100 Pcs

Cup made of steel and plastic, arm made of zinc

Mounting plates



Cam adjustable mounting plate
→ see page 3.97



Steel mounting plates
→ see page 3.99



Zinc diecast mounting plates
→ see page 3.99



Face frame adapters
→ see page 3.101

Hinge cup screws

If not pre-mounted

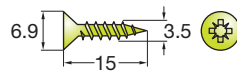

820-6308-050

10000 Pcs

Accessories



Cover caps for hinge arm
→ see page 3.151

Legend of hinge cup symbols

Screw-on ready
← screws



Damping adjustment

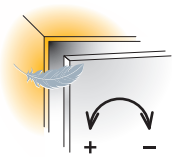

Door adjustment

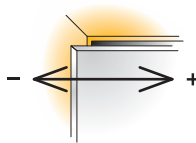

Side adjustment
+3/-1mm

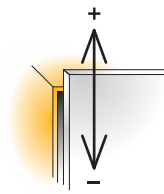

Height adjustment
+2/-2mm

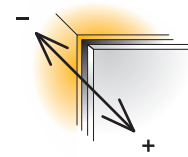

Depth adjustment
+5/-1.5mm

For further explanation → see page 3.25

For further explanation → see pages 3.20-3.23

Mounting details

Mounting plate drilling distance

Mounting plate thickness table

For further explanation → see page 3.11

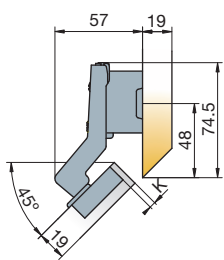

Drawings show application on D=18mm thick mounting plate

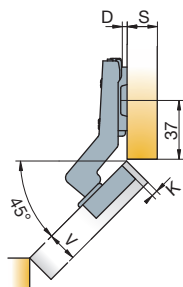

Drawings show application on D=0mm thick mounting plate

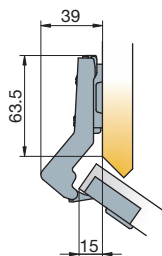
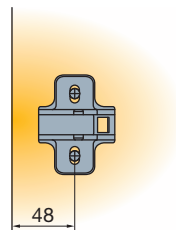

Drawings show application on D=0mm thick mounting plate

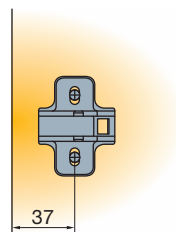
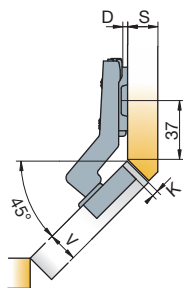

K	3	4	5
D	0	1	2

Door clearance

For further explanation → see page 3.12

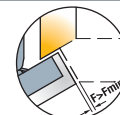

V	16	17	18	19	20	21	22
3	0.3	0.5	0.7	1.0	1.3	1.7	2.5
4	0.3	0.5	0.7	0.9	1.2	1.6	2.1
5	0.3	0.5	0.7	0.9	1.2	1.5	2.0

Gap Z_{MIN}=0

S-type-i 110/90°

For wood door cabinets with blind panels

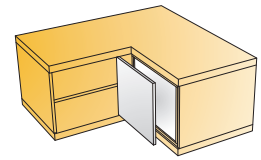

- Opening angle
- Drilling diameter for hinge cup
- Drilling depth
- Hinge on plate mounting system

110°
35mm
min. 11mm
'snap-on'



Technical details

	Interaxis 45mm	Interaxis 48mm
Cup type		
Item number	954-0E12-650	954-0E15-650

Cranking
18mm

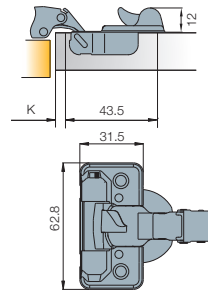

Drilling patterns for hinge cups → see page 3.15

100 Pcs

Cup made of steel and plastic, arm made of zinc

Mounting plates



Cam adjustable mounting plate
→ see page 3.97



Steel mounting plates
→ see page 3.99



Zinc diecast mounting plates
→ see page 3.99



Face frame adapters
→ see page 3.101

Hinge cup screws

If not pre-mounted

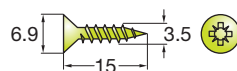

820-6308-050

10000 Pcs

Accessories



Cover caps for hinge arm
→ see page 3.151

Legend of hinge cup symbols

Screw-on ready
← screws



Damping adjustment

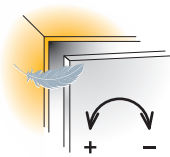

For further explanation → see page 3.25

Door adjustment

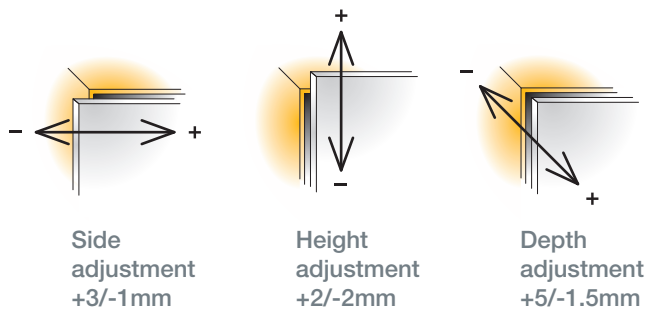

For further explanation → see pages 3.20-3.23

Mounting details

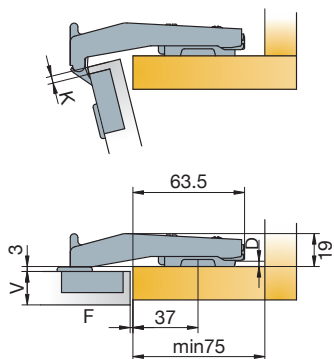

Drawings show application on D=0mm thick mounting plate

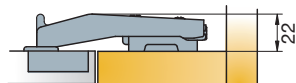

Drawings show application on D=3mm thick mounting plate

Mounting plate drilling distance

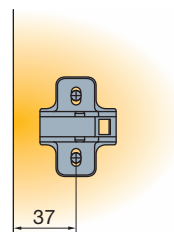

Door clearance

For further explanation → see page 3.12

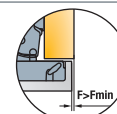

V	16	17	18	19	20	21	22
3	0.3	0.5	0.7	1.0	1.3	1.7	2.5
K 4	0.3	0.5	0.7	0.9	1.2	1.6	2.1
5	0.3	0.5	0.7	0.9	1.2	1.5	2.0

Gap Z_{MIN}=0

S-type Plus 110

For wood doors

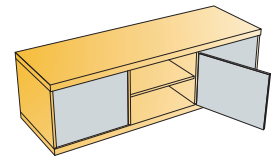
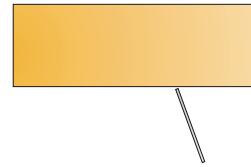
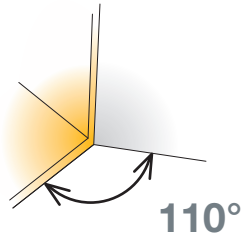

- Opening angle
- Drilling diameter for hinge cup
- Drilling depth
- Hinge on plate mounting system

110°
35mm
11.5mm
'snap-on'



	Interaxis 45mm	Interaxis 48mm	Interaxis 52mm
Cup type	Item number	Item number	Item number

Cranking
0mm



	248-0T10-050	248-0T70-050	248-0T93-050
	248-0T13-050	248-0T71-050	248-0T94-050
	248-0T69-050	248-0T72-050	248-0T95-050

Drilling patterns for hinge cups → see page 3.15

200 Pcs

Made of steel

Cranking
9mm

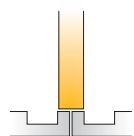

	248-0V69-050	248-0V71-050	
	248-0V70-050	248-0V72-050	248-0274-050
	248-0V56-050		248-0377-050

Drilling patterns for hinge cups → see page 3.15

200 Pcs

Made of steel

Mounting plates



Cam adjustable mounting plate
→ see page 3.97



Steel mounting plates
→ see page 3.99



Zinc diecast mounting plates
→ see page 3.99



Face frame adapters
→ see page 3.101

Hinge cup screws

If not pre-mounted

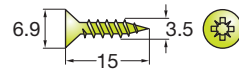

820-6308-050

10000 Pcs

Accessories



Cover caps for hinge arm
→ see page 3.151



Push latch
→ see page 3.149

Legend of hinge cup symbols

Screw-on ready
← screws

Machine insertion ready

Easy-fix system



Door adjustment

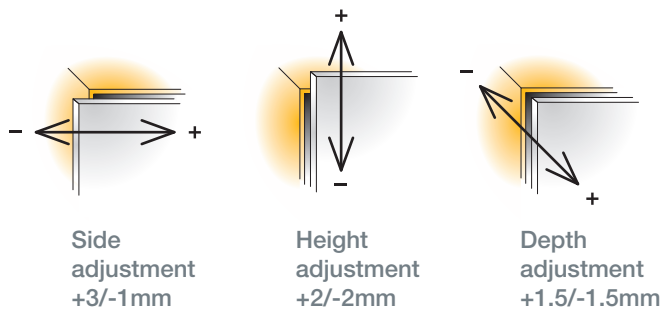

For further explanation → see pages 3.20-3.23

Mounting details

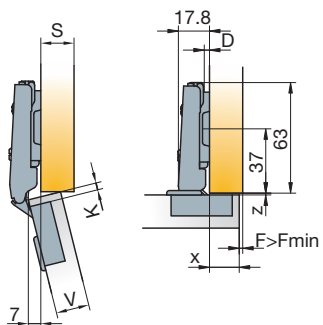

Drawings show application on D=0mm thick mounting plate

Mounting plate drilling distance

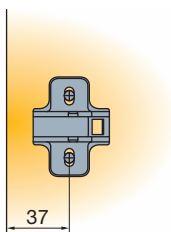

Mounting plate thickness table

For further explanation → see page 3.11

x	13	14	15	16	17	18
3	3	2	1	0		
K 4		3	2	1	0	
5			3	2	1	0

$D=13+K-x$

x	4	5	6	7	8	9
---	---	---	---	---	---	---

3	3	2	1	0		
K 4		3	2	1	0	
5			3	2	1	0

$D=4+K-x$

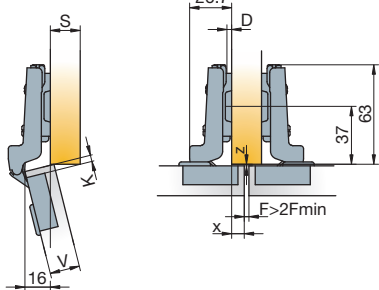

Drawings show application on D=0mm thick mounting plate

Soft closing systems

Glissando TL
→ see page 2.15

Glissando CR
→ see page 2.19

Door clearance

For further explanation → see page 3.12

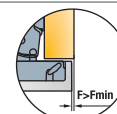

V	16	17	18	19	20	21	22
3	0.3	0.5	0.7	1.0	1.3	1.7	2.5
K 4	0.3	0.5	0.7	0.9	1.2	1.6	2.1
5	0.3	0.5	0.7	0.9	1.2	1.5	2.0

Gap $Z_{MIN}=0$

S-type Plus 110

Touch opening

For wood doors without handles

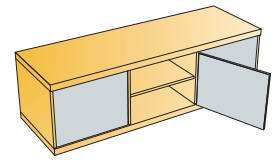
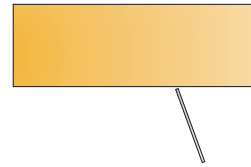
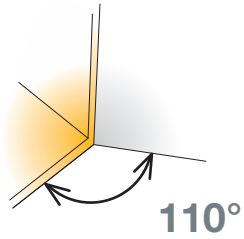

- Opening angle 110°
- Drilling diameter for hinge cup 35mm
- Drilling depth 11.5mm
- Hinge on plate mounting system 'snap-on'



Cup type	Interaxis 45mm	Interaxis 48mm	Interaxis 52mm
	Item number	Item number	Item number

Cranking 0mm



200 Pcs

Made of steel



	915-0Z85-050	915-0Z96-050	
--	--------------	--------------	--

Drilling patterns for hinge cups → see page 3.15

Cranking 9mm

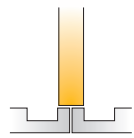

200 Pcs

Made of steel



	915-0007-050	915-0032-050	915-0012-050
--	--------------	--------------	--------------

Drilling patterns for hinge cups → see page 3.15

Catches



Catch



Catch with base plate



Knock-in pad



Self adhesive pad

100 Pcs

Made of plastic

	Catch	915-7016-380
	Catch with base plate	915-7022-380
	Knock-in pad	915-7109-050
	Self adhesive pad	915-7105-050

Mounting plates



Cam adjustable mounting plate
→ see page 3.97



Steel mounting plates
→ see page 3.99



Zinc diecast mounting plates
→ see page 3.99

Hinge cup screws
If not pre-mounted

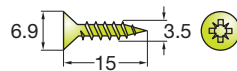

820-6308-050

10000 Pcs

Legend of hinge cup symbols

Screw-on ready
← screws



- Hinge integrated self-opening mechanism
- Effortless opening with just a light touch

Door adjustment

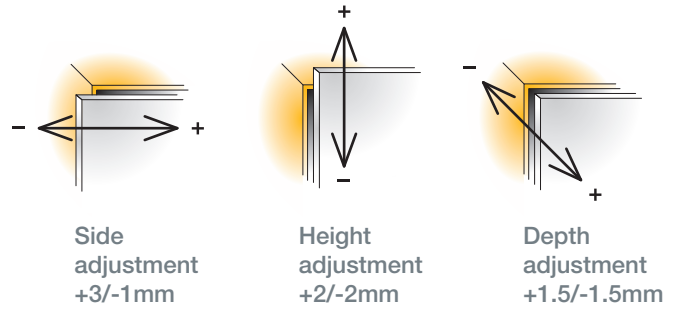

For further explanation → see pages 3.20-3.23

Mounting details

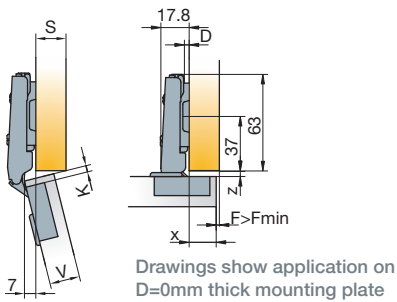

Mounting plate drilling distance

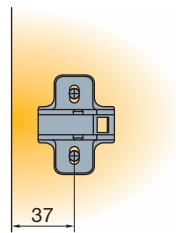

Mounting plate thickness table

For further explanation → see page 3.11

x	13	14	15	16	17	18
3	3	2	1	0		
K	4	3	2	1	0	
5			3	2	1	0

$D=13+K-x$

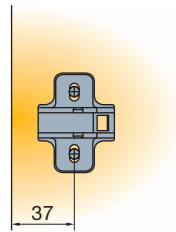
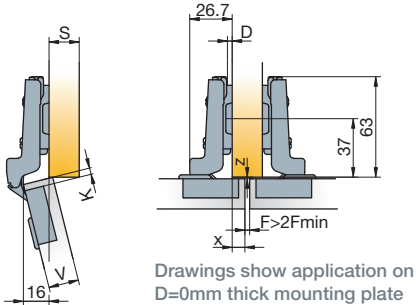

x	4	5	6	7	8	9
3	3	2	1	0		
K	4	3	2	1	0	
5			3	2	1	0

$D=4+K-x$

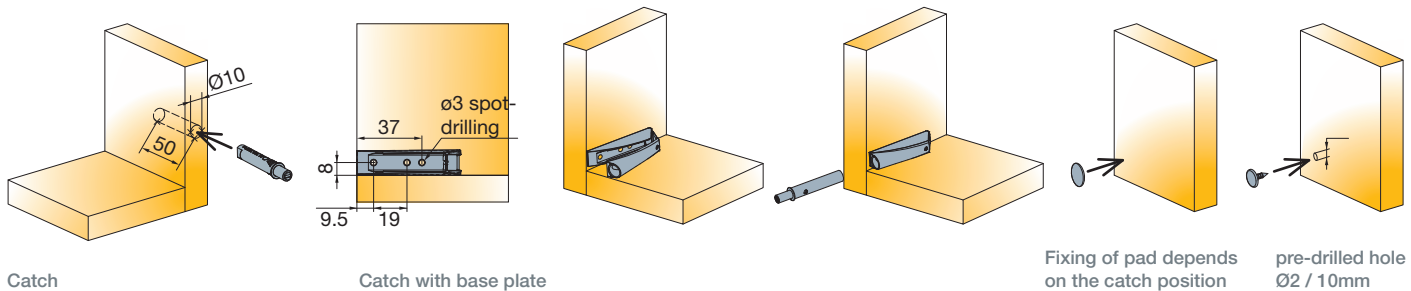

Accessories



Door clearance

For further explanation → see page 3.12

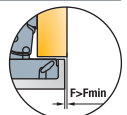

V	16	17	18	19	20	21	22
3	0.3	0.5	0.7	1.0	1.3	1.7	2.5
K	4	0.3	0.5	0.7	0.9	1.2	1.6
5	0.3	0.5	0.7	0.9	1.2	1.5	2.0

Gap $Z_{MIN}=0$

S-type 110

For wood doors

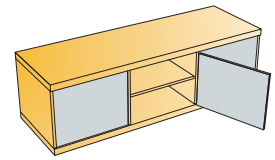
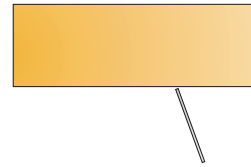

- Opening angle 110°
- Drilling diameter for hinge cup 35mm
- Drilling depth 11.5mm
- Hinge on plate mounting system 'snap-on'



Cup type	Interaxis 45mm	Interaxis 48mm	Interaxis 52mm
	Item number	Item number	Item number

Cranking 0mm



200 Pcs

Made of steel



	248-0535-050	248-0532-050	248-0538-050
	248-0171-050	248-0172-050	248-0400-050
	248-0186-050	248-0188-050	248-0366-050
	248-0197-050		

Drilling patterns for hinge cups → see page 3.15

Cranking 9mm

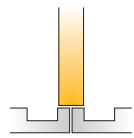

200 Pcs

Made of steel



	248-0536-050	248-0533-050	248-0539-050
	248-0279-050	248-0327-050	248-0401-050
	248-0482-050	248-0545-050	248-0549-050

Drilling patterns for hinge cups → see page 3.15

Cranking 15mm

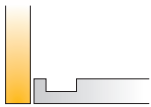

200 Pcs

Made of steel



	248-0537-050	248-0534-050	248-0540-050
	248-0280-050	248-0328-050	248-0402-050
	248-0487-050	248-0547-050	248-0551-050

Drilling patterns for hinge cups → see page 3.15

Mounting plates



Cam adjustable mounting plate
→ see page 3.97



Steel mounting plates
→ see page 3.99



Zinc diecast mounting plates
→ see page 3.99



Face frame adapters
→ see page 3.101

Hinge cup screws

If not pre-mounted

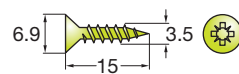

820-6308-050

10000 Pcs

Legend of hinge cup symbols

- Screw-on ready ← screws
- Machine insertion ready
- Easy-fix system
- Preinserted expando dowels

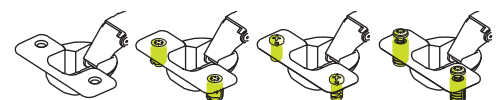

Door adjustment

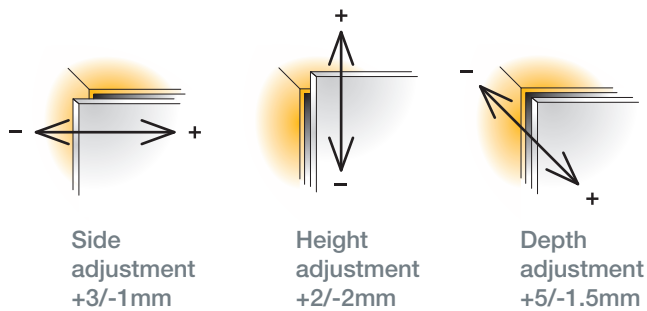

For further explanation → see pages 3.20-3.23

Mounting details

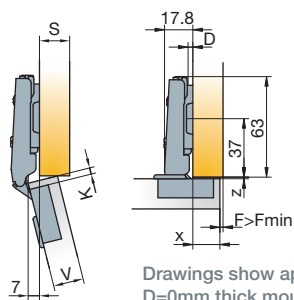

Mounting plate drilling distance

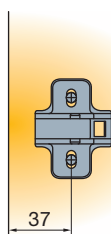

Mounting plate thickness table

For further explanation → see page 3.11

x	13	14	15	16	17	18
3	3	2	1	0		
K	4	3	2	1	0	
5			3	2	1	0

$D=13+K-x$

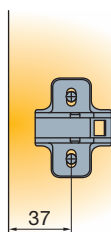
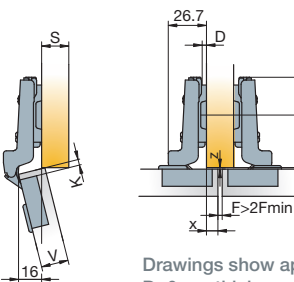

x	4	5	6	7	8	9
3	3	2	1	0		
K	4	3	2	1	0	
5			3	2	1	0

$D=4+K-x$

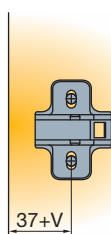
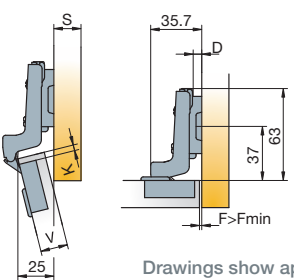

V	16	17	18	19	20	21
3	2	2	2	3	3	3
K	4	3	3	3		
5	3					

$D=-2+K-F$

Soft closing systems

Glissando TL
→ see page 2.15

Glissando CR
→ see page 2.19

Accessories

Cover caps for hinge arm
→ see page 3.151

Push latch
→ see page 3.149

Door clearance

For further explanation → see page 3.12



V	16	17	18	19	20	21	22
3	0.3	0.5	0.7	1.0	1.3	1.7	2.5
K	4	0.3	0.5	0.7	0.9	1.2	1.6
5	0.3	0.5	0.7	0.9	1.2	1.5	2.0

Gap $Z_{MIN}=0$

S-type 110/-15°

-15° angled application for wood doors

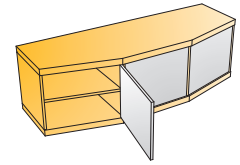
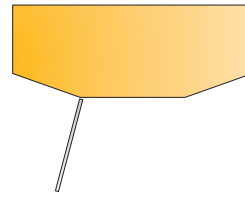

- Opening angle
- Drilling diameter for hinge cup
- Drilling depth
- Hinge on plate mounting system

110°
35mm
11.5mm
'snap-on'



	Interaxis 45mm	Interaxis 48mm	Interaxis 52mm
Cup type	Item number	Item number	Item number
	248-0V14-050	248-0V39-050	248-0V40-050
	248-0V41-050	248-0V42-050	248-0V43-050

Cranking
0mm

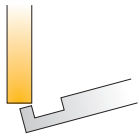

Drilling patterns for hinge cups → see page 3.15

100 Pcs

Cup made of steel, arm made of zinc

Mounting plates



Cam adjustable mounting plate
→ see page 3.97



Steel mounting plates
→ see page 3.99



Zinc diecast mounting plates
→ see page 3.99

Hinge cup screws

If not pre-mounted

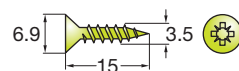

820-6308-050

10000 Pcs

Legend of hinge cup symbols

Screw-on ready
← screws

Machine insertion ready



Door adjustment

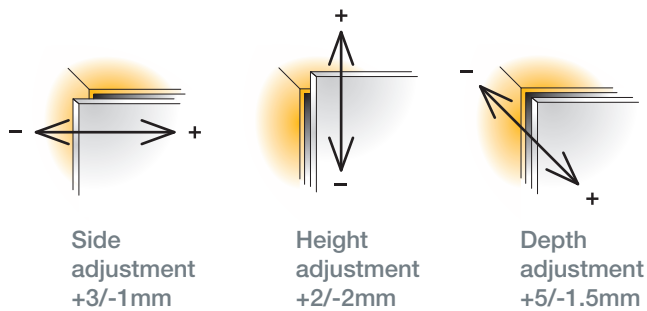

For further explanation → see pages 3.20-3.23

Mounting details

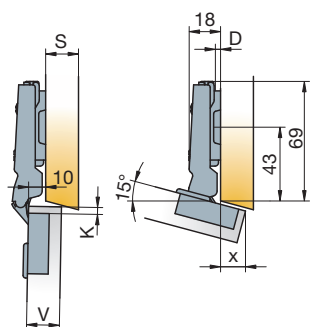

Mounting plate drilling distance

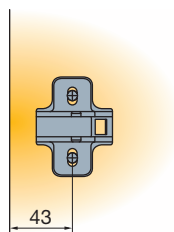

Mounting plate thickness table

For further explanation → see page 3.11

x	4	5	6	10	11	12	13	14	15
3	9			3	2	1	0		
K 4		9			3	2	1	0	
5			9			3	2	1	0

Drawings show application on D=0mm thick mounting plate

Accessories



Cover caps for hinge arm
→ see page 3.151

Door clearance

For further explanation → see page 3.12

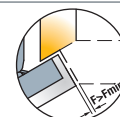

V	16	17	18	19	20	21	22
3	0.3	0.5	0.7	1.0	1.3	1.7	2.5
K 4	0.3	0.5	0.7	0.9	1.2	1.6	2.1
5	0.3	0.5	0.7	0.9	1.2	1.5	2.0

Gap Z_{MIN}=0

S-type 110/15°

15° angled application for wood doors

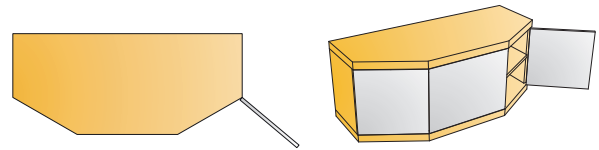
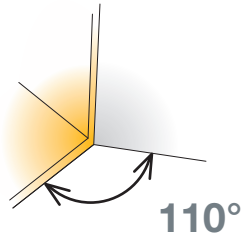

- Opening angle 110°
- Drilling diameter for hinge cup 35mm
- Drilling depth 11.5mm
- Hinge on plate mounting system 'snap-on'



	Interaxis 45mm	Interaxis 48mm	Interaxis 52mm
Cup type	Item number	Item number	Item number
	248-0080-050	248-0V62-050	248-0C66-050

Cranking
9mm

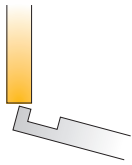

Drilling patterns for hinge cups → see page 3.15

100 Pcs

Cup made of steel, arm made of zinc

Mounting plates



Cam adjustable mounting plate
→ see page 3.97



Steel mounting plates
→ see page 3.99



Zinc diecast mounting plates
→ see page 3.99

Hinge cup screws If not pre-mounted

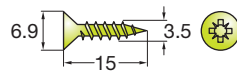

820-6308-050

10000 Pcs

Legend of hinge cup symbols

Screw-on ready
← screws



Door adjustment

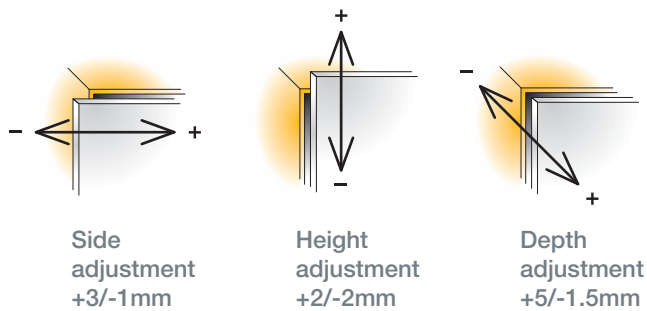

For further explanation → see pages 3.20-3.23

Mounting details

Mounting plate drilling distance

Mounting plate thickness table

For further explanation → see page 3.11

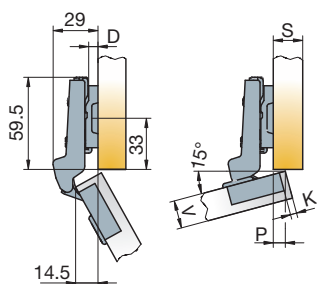

Drawings show application on D=0 and K=4mm thick mounting plate

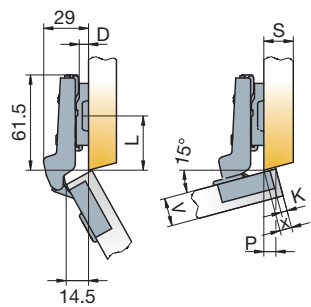
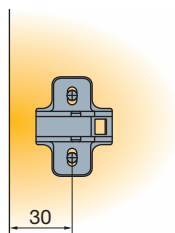

Drawings show application on D=0 and K=4mm thick mounting plate

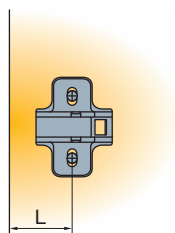

L=37 for thickness D=0
 L=36 for thickness D=1
 L=36 for thickness D=2
 L=35 for thickness D=3
 L=33 for thickness D=9

x,P 1 2 3 7 8 9 10 11 12

3	9		3	2	1	0			
K 4		9		3	2	1	0		
5			9		3	2	1	0	D

Soft closing systems



Accessories



Door clearance

For further explanation → see page 3.12

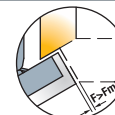

V 16 17 18 19 20 21 22

3	0.3	0.5	0.7	1.0	1.3	1.7	2.5
K 4	0.3	0.5	0.7	0.9	1.2	1.6	2.1
5	0.3	0.5	0.7	0.9	1.2	1.5	2.0

Gap Z_{MIN}=0

S-type 110/24°

24° angled application for wood doors

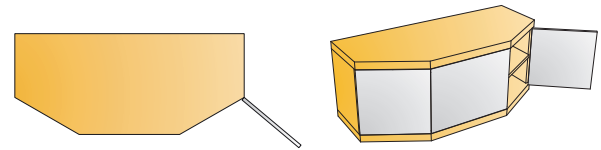
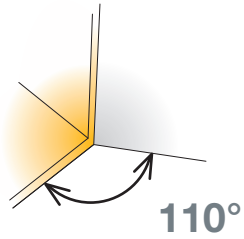

- Opening angle 110°
- Drilling diameter for hinge cup 35mm
- Drilling depth 11.5mm
- Hinge on plate mounting system 'snap-on'



	Interaxis 45mm	Interaxis 48mm	Interaxis 52mm
Cup type	Item number	Item number	Item number
	248-0V18-050	248-0V45-050	248-0Z29-050
	248-0V47-050	248-0V48-050	248-0V49-050

Cranking
9mm

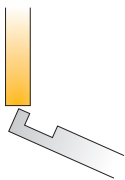

Drilling patterns for hinge cups → see page 3.15

100 Pcs

Cup made of steel, arm made of zinc

Mounting plates



Cam adjustable mounting plate
→ see page 3.97



Steel mounting plates
→ see page 3.99



Zinc diecast mounting plates
→ see page 3.99

Hinge cup screws If not pre-mounted

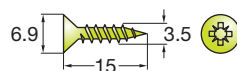

820-6308-050

10000 Pcs

Legend of hinge cup symbols

Screw-on ready
← screws

Machine insertion ready



Door adjustment

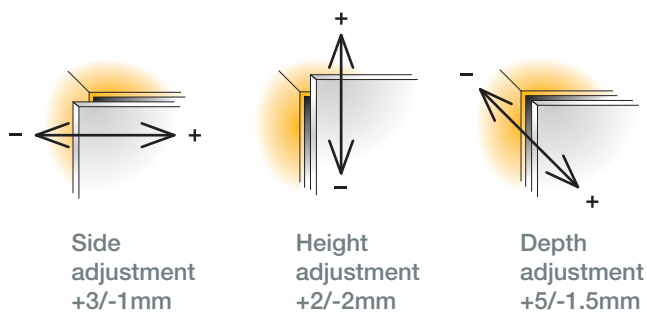

For further explanation → see pages 3.20-3.23

Mounting details

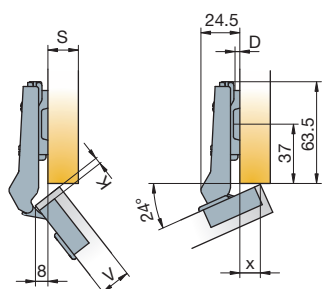

Mounting plate drilling distance

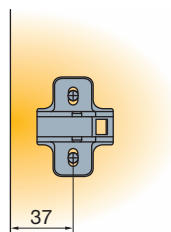

Mounting plate thickness table

For further explanation → see page 3.11

x	3	4	5	9	10	11	12	13	14
3	9			3	2	1	0		
K 4		9			3	2	1	0	
5			9			3	2	1	0 D

Drawings show application on D=0mm thick mounting plate

Soft closing systems



Accessories



Door clearance

For further explanation → see page 3.12

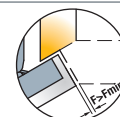

V	16	17	18	19	20	21	22
3	0.3	0.5	0.7	1.0	1.3	1.7	2.5
K 4	0.3	0.5	0.7	0.9	1.2	1.6	2.1
5	0.3	0.5	0.7	0.9	1.2	1.5	2.0 F _{MIN}

Gap Z_{MIN}=0

S-type 110/30°

30° angled application for wood doors

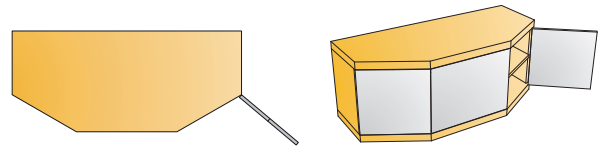
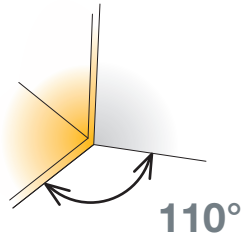

- Opening angle 110°
- Drilling diameter for hinge cup 35mm
- Drilling depth 11.5mm
- Hinge on plate mounting system 'snap-on'



	Interaxis 45mm	Interaxis 48mm	Interaxis 52mm
Cup type	Item number	Item number	Item number
	248-0675-050	248-0665-050	248-0677-050
	248-0N12-050	248-0N13-050	248-0N14-050

Cranking
9mm

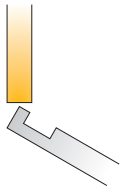

Drilling patterns for hinge cups → see page 3.15

200 Pcs

Cup made of steel, arm made of zinc

Mounting plates



Cam adjustable mounting plate
→ see page 3.97



Steel mounting plates
→ see page 3.99



Zinc diecast mounting plates
→ see page 3.99

Hinge cup screws

If not pre-mounted

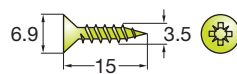

820-6308-050

10000 Pcs

Legend of hinge cup symbols

Screw-on ready
← screws

Machine insertion ready



Door adjustment

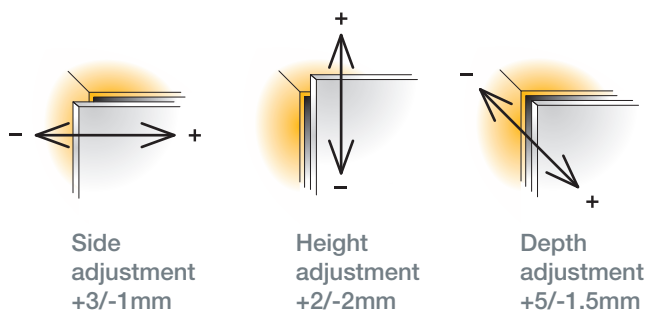

For further explanation → see pages 3.20-3.23

Mounting details

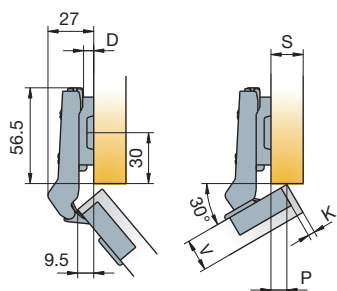

Drawings show application on D=3mm thick mounting plate

Mounting plate drilling distance

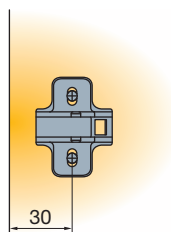

Mounting plate thickness table

For further explanation → see page 3.11

P	2.5	3.5	4.5	8.5	9.5	10.5	11.5	12.5	13.5
3	9			3	2	1	0		
K	4	9			3	2	1	0	
5			9			3	2	1	0

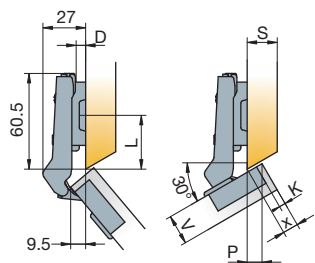

Drawings show application on D=3mm thick mounting plate

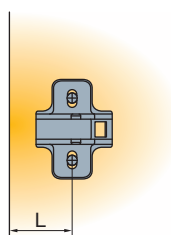

x	2	3	4	9	10	11	12	13	14	15
3	9			3	2			0		
K	4	9			3	2			0	
5			9			3	2			0

L=37 for thickness D=0
 L=36 for thickness D=1
 L=35 for thickness D=2
 L=34 for thickness D=3
 L=31 for thickness D=9

Soft closing systems



Accessories



Door clearance

For further explanation → see page 3.12

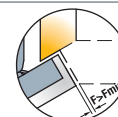

V	16	17	18	19	20	21	22
3	0.3	0.5	0.7	1.0	1.3	1.7	2.5
K	4	0.3	0.5	0.7	0.9	1.2	1.6
5	0.3	0.5	0.7	0.9	1.2	1.5	2.0

Gap Z_{MIN}=0

S-type 110/45°

45° angled application for wood doors

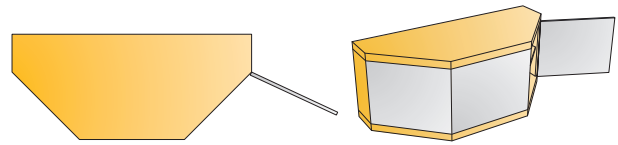

- Opening angle 110°
- Drilling diameter for hinge cup 35mm
- Drilling depth 11.5mm
- Hinge on plate mounting system 'snap-on'



	Interaxis 45mm	Interaxis 48mm	Interaxis 52mm
Cup type	Item number	Item number	Item number
	248-0433-050	248-0431-050	248-0518-050
	248-0N16-050	248-0N17-050	248-0N18-050

Cranking
9mm

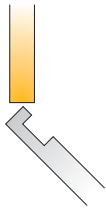

Drilling patterns for hinge cups → see page 3.15

200 Pcs

Cup made of steel, arm made of zinc

Mounting plates



Cam adjustable mounting plate
→ see page 3.97



Steel mounting plates
→ see page 3.99



Zinc diecast mounting plates
→ see page 3.99

Hinge cup screws If not pre-mounted

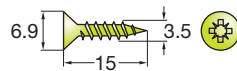

820-6308-050

10000 Pcs

Legend of hinge cup symbols

Screw-on ready
← screws

Machine insertion ready



Door adjustment

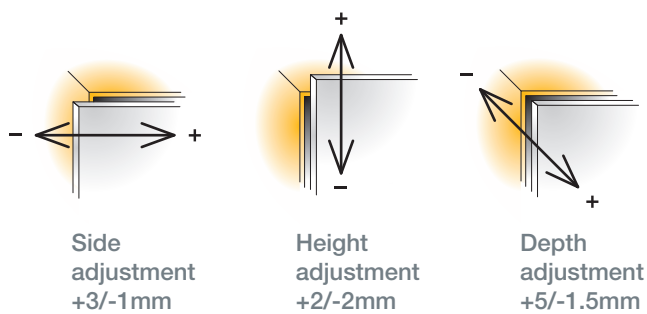

For further explanation → see pages 3.20-3.23

Mounting details

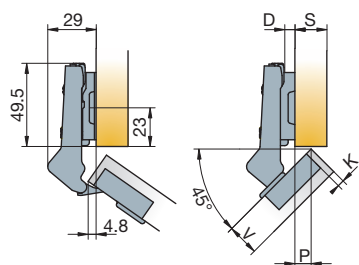

Drawings show application on D=3mm thick mounting plate

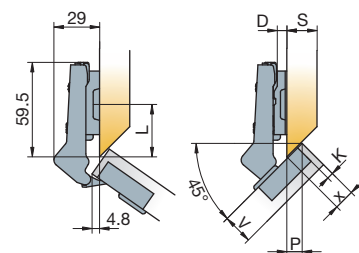

Drawings show application on D=3mm thick mounting plate

Mounting plate drilling distance

Mounting plate thickness table
For further explanation → see page 3.11

P	9	9.5	10	10.5	11	11.5	12	12.5	13.5
3	3		2		1		0		
K 4		3		2		1		0	
5				3		2		1	0 D

x 11.5 12.5 13 13.5 14 14.5 15 15.5 16 16.5 17 18

3	3		2			1			0			
K 4		3			2			1			0	
5					3			2		1		0 D

L=36 for thickness D=0
L=35 for thickness D=1
L=34 for thickness D=2
L=33 for thickness D=3

Soft closing systems



Accessories



Door clearance

For further explanation → see page 3.12

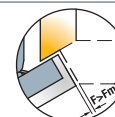

V	16	17	18	19	20	21	22
3	0.3	0.5	0.7	1.0	1.3	1.7	2.5
K 4	0.3	0.5	0.7	0.9	1.2	1.6	2.1
5	0.3	0.5	0.7	0.9	1.2	1.5	2.0 F _{MIN}

Gap Z_{MIN}=0

S-type 110/45°

45° angled application for wood doors

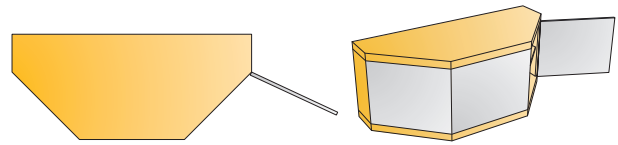
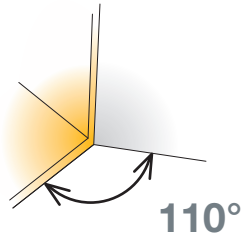

- Opening angle 110°
- Drilling diameter for hinge cup 35mm
- Drilling depth 11.5mm
- Hinge on plate mounting system 'snap-on'



	Interaxis 45mm	Interaxis 48mm	Interaxis 52mm
Cup type	Item number	Item number	Item number
	248-0285-050	248-0283-050	248-0291-050
	248-0N20-050	248-0N21-050	248-0N22-050

Cranking
18mm

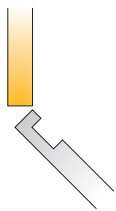

Drilling patterns for hinge cups → see page 3.15

100 Pcs

Cup made of steel, arm made of zinc

Mounting plates



Cam adjustable mounting plate
→ see page 3.97



Steel mounting plates
→ see page 3.99



Zinc diecast mounting plates
→ see page 3.99



Face frame adapters
→ see page 3.101

Hinge cup screws

If not pre-mounted

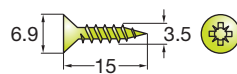

820-6308-050

10000 Pcs

Legend of hinge cup symbols

Screw-on ready
← screws

Machine insertion ready



Door adjustment

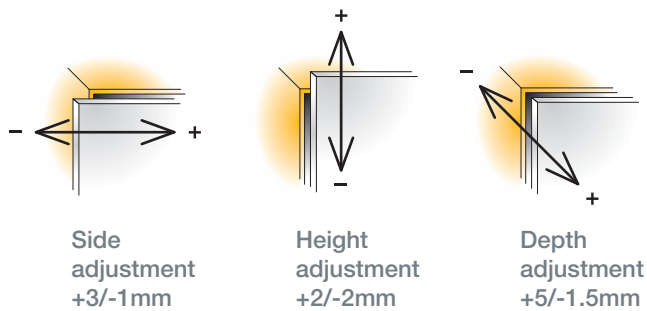

For further explanation → see pages 3.20-3.23

Mounting details

Mounting plate drilling distance

Mounting plate thickness table
For further explanation → see page 3.11

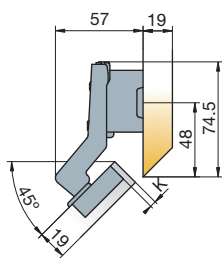

Drawings show application on D=18mm thick mounting plate

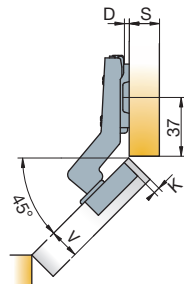

Drawings show application on D=0mm thick mounting plate

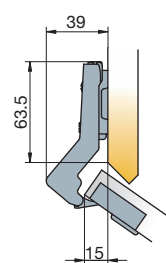
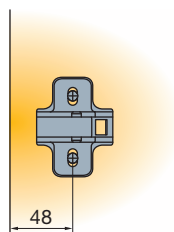

Drawings show application on D=0mm thick mounting plate

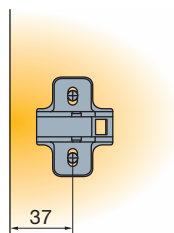
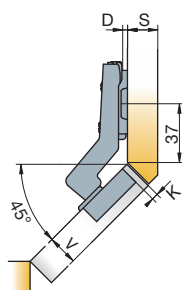

K	3	4	5
D	0	1	2

Soft closing systems



Accessories



Door clearance

For further explanation → see page 3.12

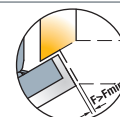

V	16	17	18	19	20	21	22
3	0.3	0.5	0.7	1.0	1.3	1.7	2.5
K 4	0.3	0.5	0.7	0.9	1.2	1.6	2.1
5	0.3	0.5	0.7	0.9	1.2	1.5	2.0

F_{MIN}

Gap Z_{MIN}=0

S-type 110/90°

For wood door cabinets with blind panels

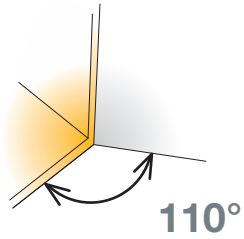
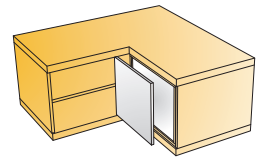

- Opening angle 110°
- Drilling diameter for hinge cup 35mm
- Drilling depth 11.5mm
- Hinge on plate mounting system 'snap-on'



Cranking
18mm



	Interaxis 45mm	Interaxis 48mm	Interaxis 52mm
Cup type	Item number	Item number	Item number
	248-0745-050	248-0742-050	248-0748-050
	248-0N24-050	248-0N25-050	248-0N26-050
	248-0L61-050	248-0N62-050	248-0Z81-050

Drilling patterns for hinge cups → see page 3.15

100 Pcs

Cup made of steel, arm made of zinc

Mounting plates



Cam adjustable mounting plate
→ see page 3.97



Steel mounting plates
→ see page 3.99



Zinc diecast mounting plates
→ see page 3.99



Face frame adapters
→ see page 3.101

Hinge cup screws

If not pre-mounted

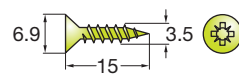

820-6308-050

10000 Pcs

Legend of hinge cup symbols

Screw-on ready
← screws

Machine insertion ready

Easy-fix system



Door adjustment

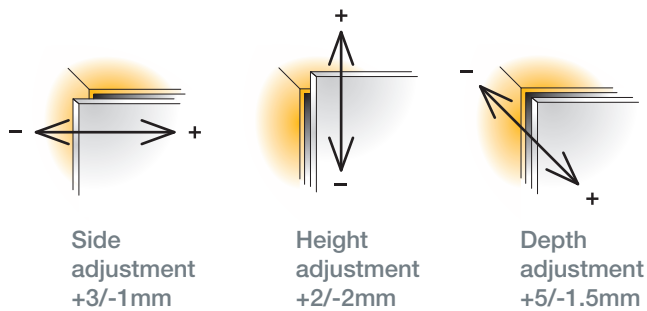

For further explanation → see pages 3.20-3.23

Mounting details

Mounting plate drilling distance

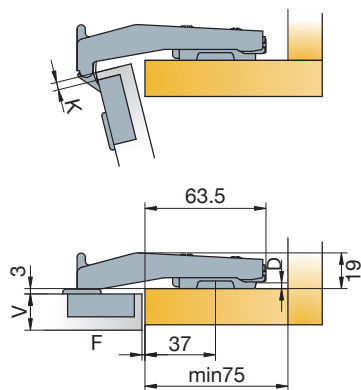

Drawings show application on D=0mm thick mounting plate

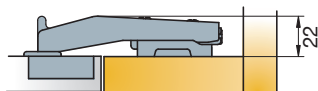

Drawings show application on D=3mm thick mounting plate

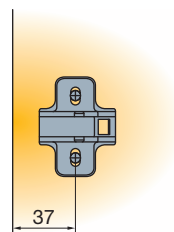

Soft closing systems



Glissando TL
→ see page 2.15

Accessories



Cover caps for hinge arm
→ see page 3.151

Door clearance

For further explanation → see page 3.12



V	16	17	18	19	20	21	22	
3	0.3	0.5	0.7	1.0	1.3	1.7	2.5	
K	4	0.3	0.5	0.7	0.9	1.2	1.6	2.1
5	0.3	0.5	0.7	0.9	1.2	1.5	2.0	F _{MIN}

Gap Z_{MIN}=0

S-type 110

For aluminium frame doors

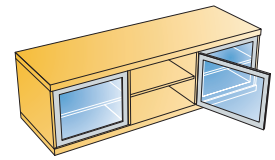
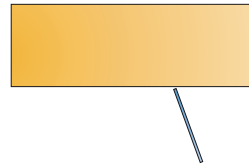
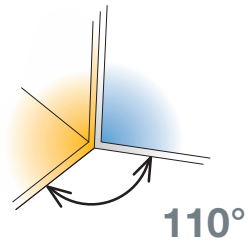

- Opening angle
- Hinge on plate mounting system

110°
'snap-on'



Interaxis
28mm

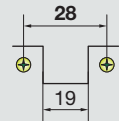

Cup type

Item number

Cranking
0mm



950-0T27-050



200 Pcs

Cup made of zinc, arm made of steel

Mounting plates



Cam adjustable mounting plate
→ see page 3.97



Steel mounting plates
→ see page 3.99



Zinc diecast mounting plates
→ see page 3.99



Face frame adapters
→ see page 3.101

Door adjustment

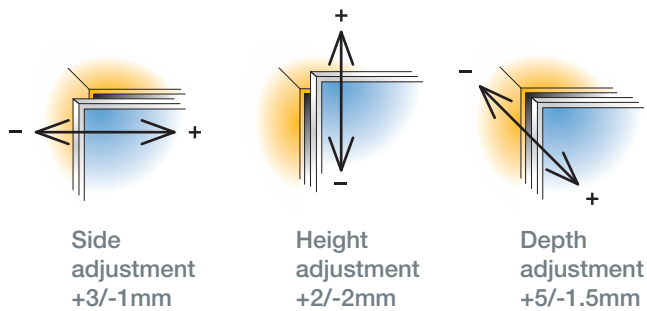

For further explanation → see pages 3.20-3.23

Mounting details

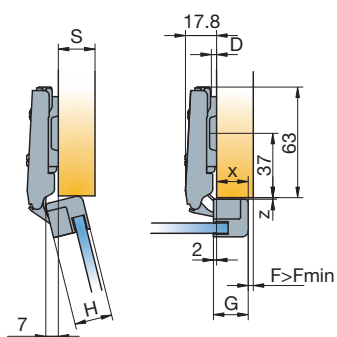

Mounting plate drilling distance

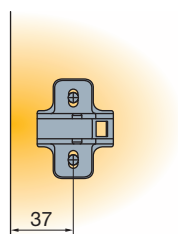

Mounting plate thickness table

For further explanation → see page 3.11

x	12	13	14	15	16	17	18
17	3	2	1	0			
18		3	2	1	0		
G			3	2	1	0	
19				3	2	1	0
20					3	2	1
							0
							D

Drawings show application on D=0mm thick mounting plate

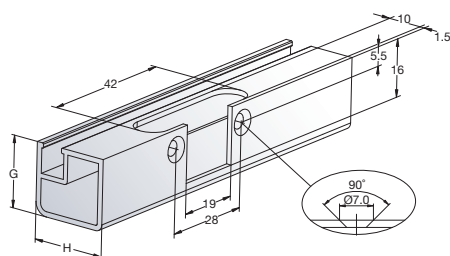

Drilling pattern for aluminium frame hinges

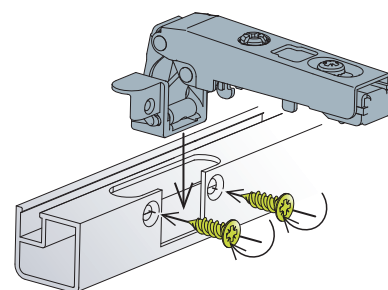

Screws included

Accessories



Cover caps for hinge arm
→ see page 3.151

Door clearance

For further explanation → see page 3.12

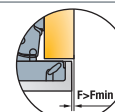

H	17	18	19	20	21	22
17	0.5	0.7	1.1	1.4	1.8	2.9
18	0.5	0.7	1.0	1.3	1.7	2.5
G						
19	0.5	0.7	0.9	1.2	1.6	2.1
20	0.5	0.7	0.9	1.2	1.5	2.0
						F _{MIN}

Gap Z_{MIN}=0.5

S-type 170

For wood doors

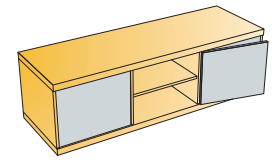
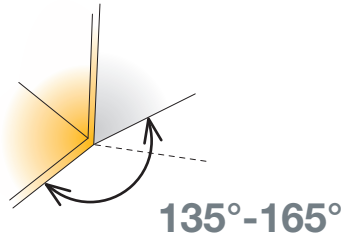

- Opening angle 135°-165°
- Drilling diameter for hinge cup 35mm
- Drilling depth 12mm
- Hinge on plate mounting system 'snap-on'

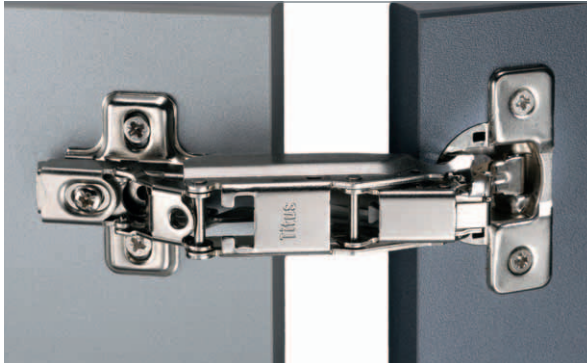

	Interaxis 45mm	Interaxis 48mm	Interaxis 52mm
Cup type	Item number	Item number	Item number

Cranking
0mm



	248-0R14-050	248-0R17-050	248-0R15-050
	248-0M73-050	248-0R13-050	248-0M74-050
	248-0198-050		

Drilling patterns for hinge cups → see page 3.15

50 Pcs

Made of steel and zinc

Cranking
0mm
With adjustable
opening angle

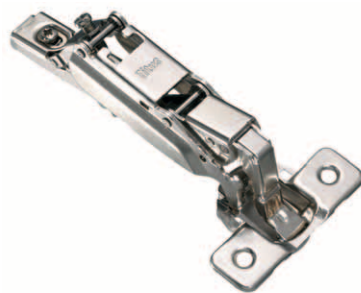

	248-0R18-050	*248-0V65-050	
		*248-0S69-050	

Drilling patterns for hinge cups → see page 3.15
* Available upon special request → see page 0.3



Adjustable opening angle 135°

50 Pcs

Made of steel and zinc

Mounting plates



Cam adjustable mounting plate
→ see page 3.97



Steel mounting plates
→ see page 3.99



Zinc diecast mounting plates
→ see page 3.99



Face frame adapters
→ see page 3.101

Hinge cup screws

If not pre-mounted

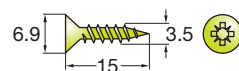

820-6308-050

10000 Pcs

Legend of hinge cup symbols

Screw-on ready
← screws

Machine insertion ready

Preinserted expando dowels



Door adjustment

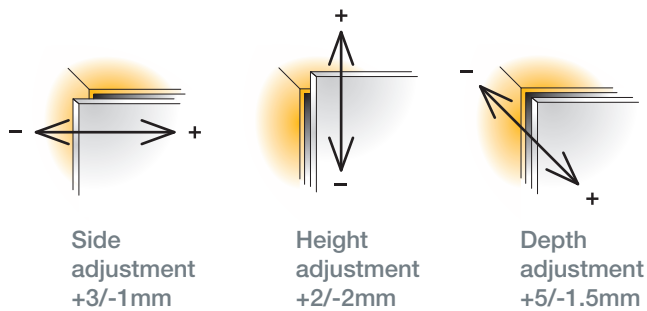

For further explanation → see pages 3.20-3.23

Mounting details

Mounting plate drilling distance

Mounting plate thickness table
For further explanation → see page 3.11

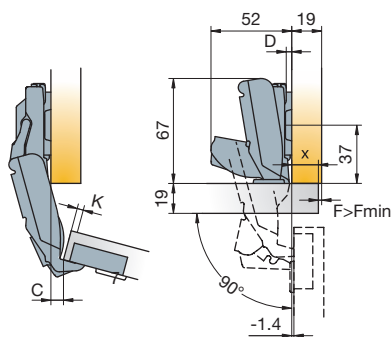

Drawings show application on D=0mm mounting plate

In 90° position the door is only 1.4mm distant from side panel

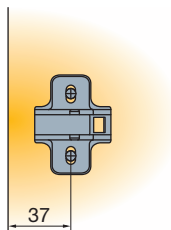

x	10	11	12	13	14	15	16	17	18	19	20
3	6	5	4	3	2	1	0				
4		6	5	4	3	2	1	0			
K 5			6	5	4	3	2	1	0		
6				6	5	4	3	2	1	0	
7					6	5	4	3	2	1	0 D

$D=13+K-x$

C value with D=0 mounting plates

K	3	4	5	6	7
C	-9.0	-8.1	-7.1	-6.1	-5.2 D

Soft closing systems



Accessories



Door clearance

For further explanation → see page 3.12

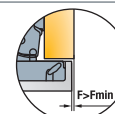

V	16	17	18	19	20	21	22	23	24
3	0.0	0.0	0.0	0.0	0.0	0.0	0.0	0.0	0.0
4	0.0	0.0	0.0	0.0	0.0	0.0	0.0	0.0	0.0
K 5	0.0	0.0	0.0	0.0	0.0	0.0	0.0	0.0	0.0
6	0.0	0.0	0.0	0.0	0.0	0.0	0.0	0.0	2.6
7	0.0	0.0	0.0	0.0	0.0	0.0	0.0	0.0	5.1 F _{MIN}

Gap Z_{MIN}=0.5

S-type 170

For wood doors

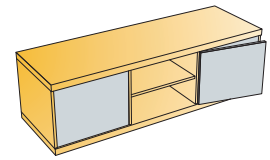
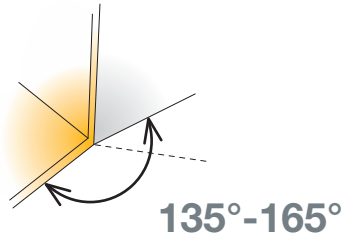

- Opening angle 135°-165°
- Drilling diameter for hinge cup 35mm
- Drilling depth 12mm
- Hinge on plate mounting system 'snap-on'

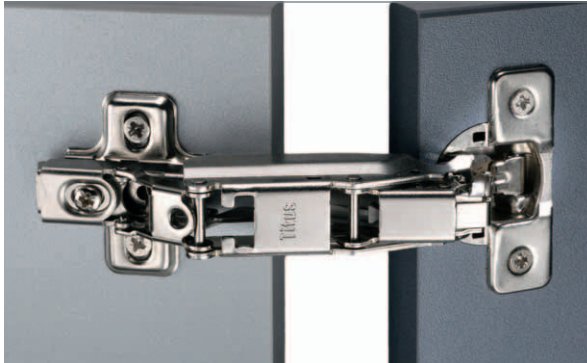

	Interaxis 45mm	Interaxis 48mm	Interaxis 52mm
Cup type	Item number	Item number	Item number

Cranking
9mm

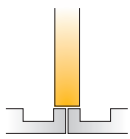

	248-0162-050	248-0163-050	
--	--------------	--------------	--

Drilling patterns for hinge cups → see page 3.15

50 Pcs

Made of steel and zinc

Mounting plates



Cam adjustable mounting plate
→ see page 3.97



Steel mounting plates
→ see page 3.99



Zinc diecast mounting plates
→ see page 3.99



Face frame adapters
→ see page 3.101

Hinge cup screws

If not pre-mounted

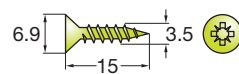

820-6308-050

10000 Pcs

Legend of hinge cup symbols

Screw-on ready
← screws



Door adjustment

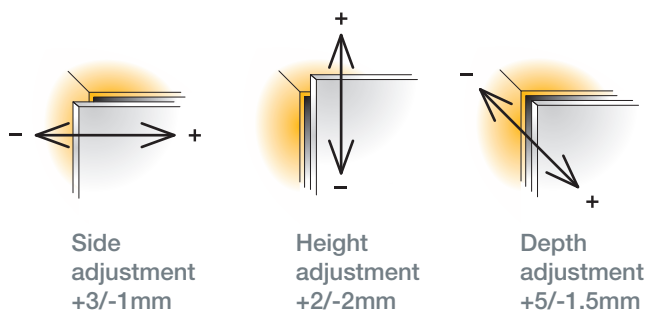

For further explanation → see pages 3.20-3.23

Mounting details

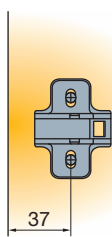
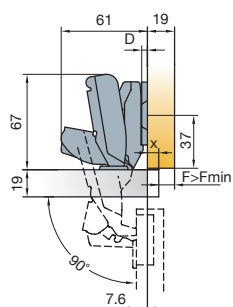
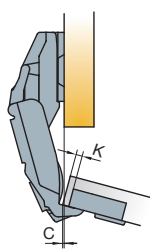

Drawings show application on D=0mm thick mounting plate

Mounting plate drilling distance

Mounting plate thickness table
For further explanation → see page 3.11

x	1	2	3	4	5	6	7	8	9	10	11
3	6			3	2	1	0				
4		6			3	2	1	0			
K 5			6			3	2	1	0		
6				6			3	2	1	0	
7					6			3	2	1	0

$D=4+K-x$

C value with D=0 mounting plates

K	3	4	5	6	7	
C	0	0.9	1.9	2.9	3.8	D

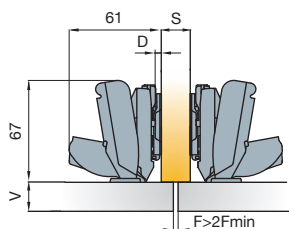

Drawings show application on D=0mm thick mounting plate

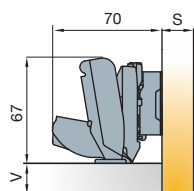

Drawings show application on D=9mm thick mounting plate

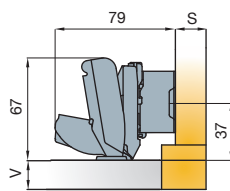

Drawings show application on D=18mm thick mounting plate

Soft closing systems



Glissando TL 170
→ see page 2.17



Glissando CR
→ see page 2.19

Accessories



Push latch
→ see page 3.149

Door clearance

For further explanation → see page 3.12

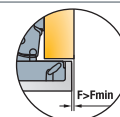

V	16	17	18	19	20	21	22	23	24
3	0.0	0.0	0.0	0.0	0.0	0.0	0.0	0.0	0.0
4	0.0	0.0	0.0	0.0	0.0	0.0	0.0	0.0	0.0
K 5	0.0	0.0	0.0	0.0	0.0	0.0	0.0	0.0	0.0
6	0.0	0.0	0.0	0.0	0.0	0.0	0.0	0.0	2.6
7	0.0	0.0	0.0	0.0	0.0	0.0	0.0	0.0	5.1 F _{MIN}

Gap Z_{MIN}=0.5

S-type

for Pie-cut Corner Cabinet

For wood doors

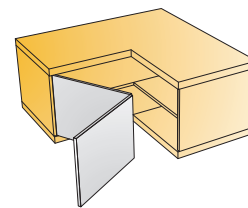

- Opening angle 110°
- Drilling diameter for hinge cup 35mm
- Drilling depth 11.5mm
- Hinge on plate mounting system 'snap-on'



	Interaxis 45mm	Interaxis 48mm	Interaxis 52mm
Cup type	Item number	Item number	Item number
	248-0U21-050	248-0U16-050	248-0308-050
	248-0U22-050	248-0V15-050	248-0Z20-050

Corner cabinet

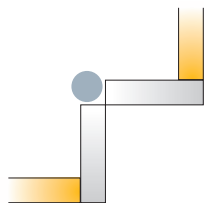

Drilling patterns for hinge cups → see page 3.15

100 Pcs

Cup made of steel, arm made of zinc

Mounting plates



Cam adjustable mounting plate
→ see page 3.97



Steel mounting plates
→ see page 3.99



Zinc diecast mounting plates
→ see page 3.99

Hinge cup screws

If not pre-mounted

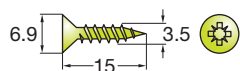

820-6308-050

10000 Pcs

Legend of hinge cup symbols

Screw-on ready
← screws

Machine insertion ready



Door adjustment

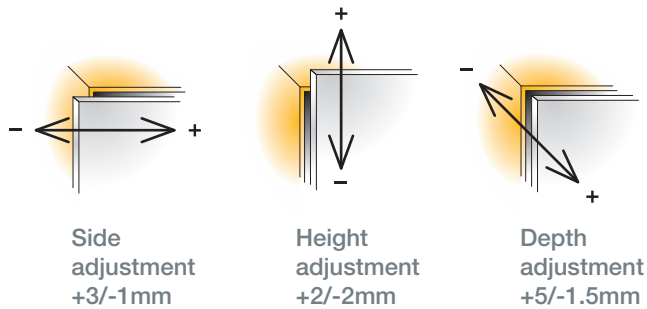

For further explanation → see pages 3.20-3.23

Mounting details

Mounting plate drilling distance

Adjustments

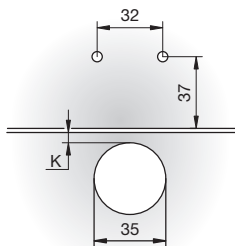
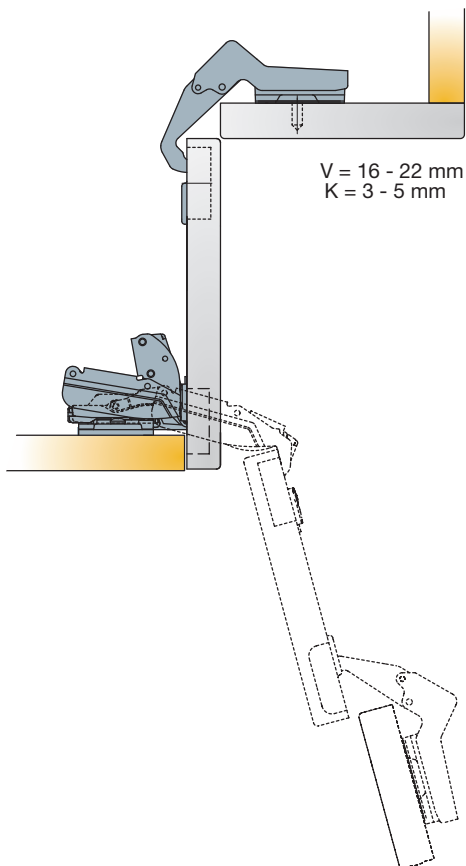

Any S-type-i mounting plate of thickness D=0 can be used

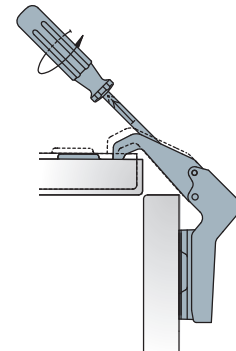

The diagonal adjustment is made by rotating the appropriate screw as shown on the drawing

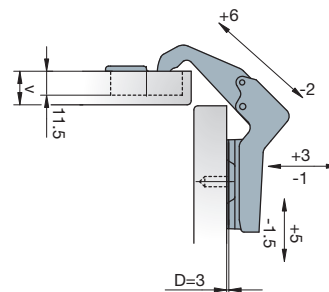

Accessories



Cover caps for hinge arm
→ see page 3.151

S-type Mounting Plates

For all S-type concealed hinges

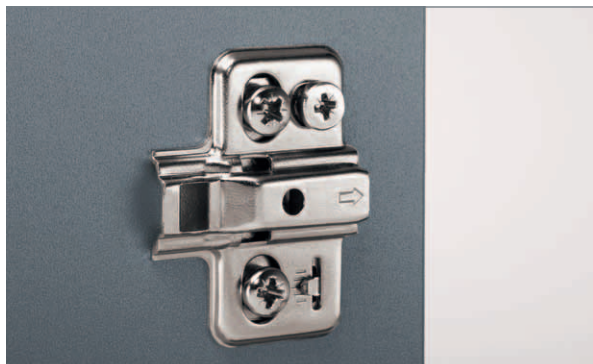
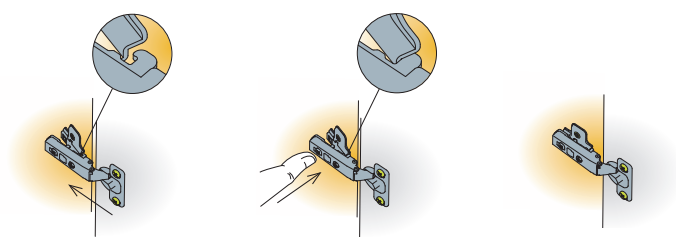

Cam adjustable
mounting plate

Drilling pattern

Dimensions

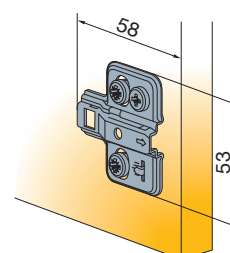
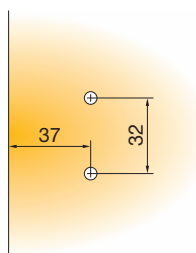

 200 Pcs Made of steel

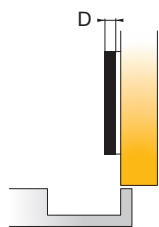

Mounting plate thickness

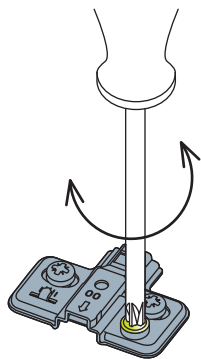

Height adjustment +/- 2mm

Mounting plate type	13	15			10.5	
Mounting plate thickness (D)						
Item number	Item number	Item number	Item number	Item number	Item number	
0mm	244-0258-050	244-0261-050	*244-0264-050	*244-0342-050	244-0270-050	
2mm	244-0259-050	244-0262-050	*244-0265-050	*244-0343-050	244-0271-050	
3mm	244-0260-050	244-0263-050	*244-0266-050	*244-0344-050	244-0272-050	
* Available upon special request → see page 0.3						

Legend of mounting plate type symbols



13

Pre-mounted
13mm euro screws

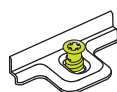

15

Pre-mounted
15mm euro screws

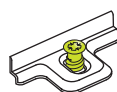

Pre-mounted
chipboard screws

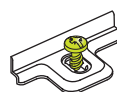

Machine
insertion ready

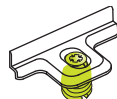

10.5

Pre-mounted
10.5mm
expanding dowels

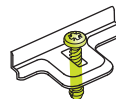

S-type Mounting Plates

For all S-type concealed hinges

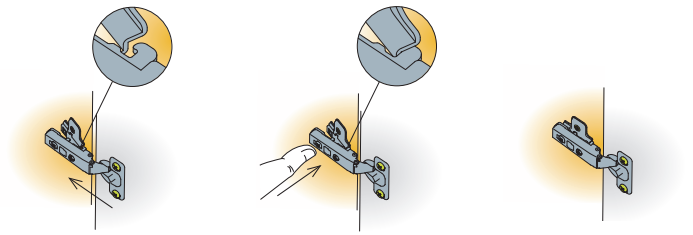

Steel mounting plates

Drilling pattern

Dimensions

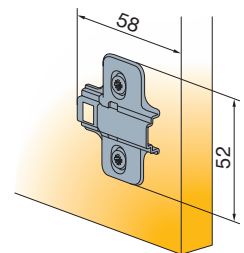
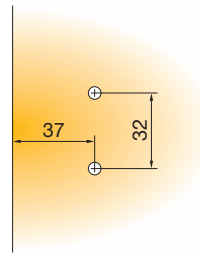

200 Pcs

Made of steel

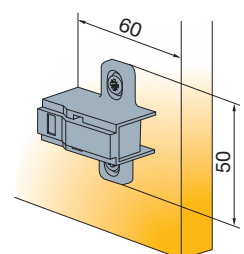
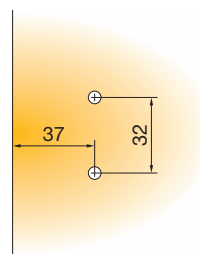

200 Pcs

Made of zinc

Fixing screws for mounting plates
If not pre-mounted

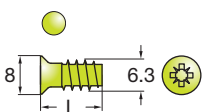

Euro screws
821-6304-050 L=11
821-6323-050 L=13
821-6332-050 L=15

 5000 Pcs

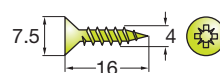

Chipboard screws
820-6328-050

 10000 Pcs

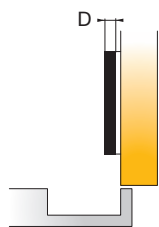

Mounting plate thickness

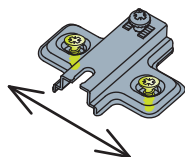

Height adjustment +/- 2mm

Mounting plate type								
Mounting plate thickness (D)								
Item number								
0mm	244-1136-050	*244-1233-050	244-0Z26-050	244-0134-050	244-0118-050	*244-0136-050	*244-0166-050	244-0P26-050
1mm	244-1137-050	*244-1228-050		244-0561-050		*244-0565-050	*244-0567-050	
2mm	244-1138-050	*244-1229-050	244-0Z63-050	244-0562-050	244-0120-050	*244-0566-050	*244-0568-050	244-0V19-050
3mm	244-1139-050	*244-1234-050		244-0135-050	244-0119-050	*244-0137-050	*244-0167-050	244-0P27-050
6mm	244-1645-050				244-0Z51-050			
	* Available upon special request → see page 0.3				* Mounting plates with pre-mounted 7.5mm expanding dowels available upon special request → see page 0.3			
9mm	244-3651-650			244-0M33-650	244-0P29-650			
18mm	244-3016-650			244-0085-650	244-0095-650			
	* Available upon special request → see page 0.3							

Legend of mounting plate type symbols

Screw on ready for euro screws ← s crews	Screw-on ready for chipboard screws	Pre-mounted 11mm euro screws	Pre-mounted 13mm euro screws	Pre-mounted 15mm euro screws	Pre-mounted chipboard screws	Machine insertion ready	Pre-mounted 10.5mm expanding dowels

S-type

Face Frame

Mounting Plates

For all S-type concealed hinges

Drilling pattern

Dimensions

Face frame adapter for
S-type hinges

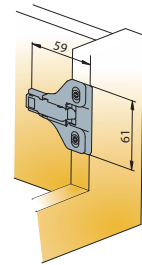
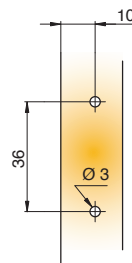

 200 Pcs Made of zinc alloy

Face frame adapter for
S-type hinges
cam adjustable

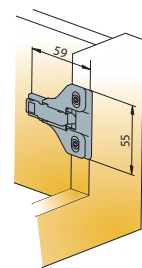
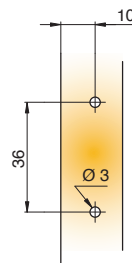

 200 Pcs Made of zinc alloy

Fixing screw for mounting plates
If not pre-mounted

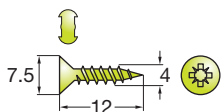

Chipboard screws
820-6328-050

 10000 Pcs

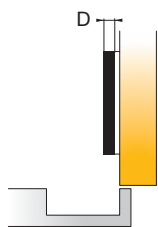

Mounting plate thickness

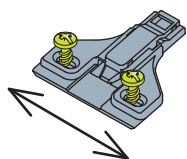

Height adjustment +/- 2mm

Mounting plate type		
Mounting plate thickness (D)	Item number	
0mm	244-3653-650	
3mm	244-3654-650	
6mm	244-3655-650	
0mm	248-3600-650	
3mm	248-3603-650	

Legend of mounting plate type symbols



Screw-on ready for chipboard screws
 ← screws

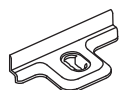

B-type Hinges

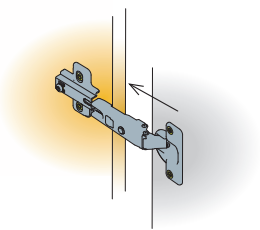

'Slide-on' mounting system

- Proven and reliable hinge-to-plate mounting solution
- Cost effectiveness

Designed for a wide use

- Solution for different applications and materials
- Proven solution for RTA furniture, household application and tall cabinets

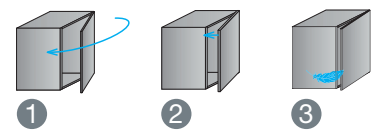

'ConfidentClose'

- 1 Fast closing
- 2 Late start of deceleration action
- 3 Quiet landing with 'SoftTouch'

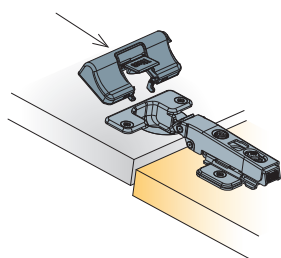
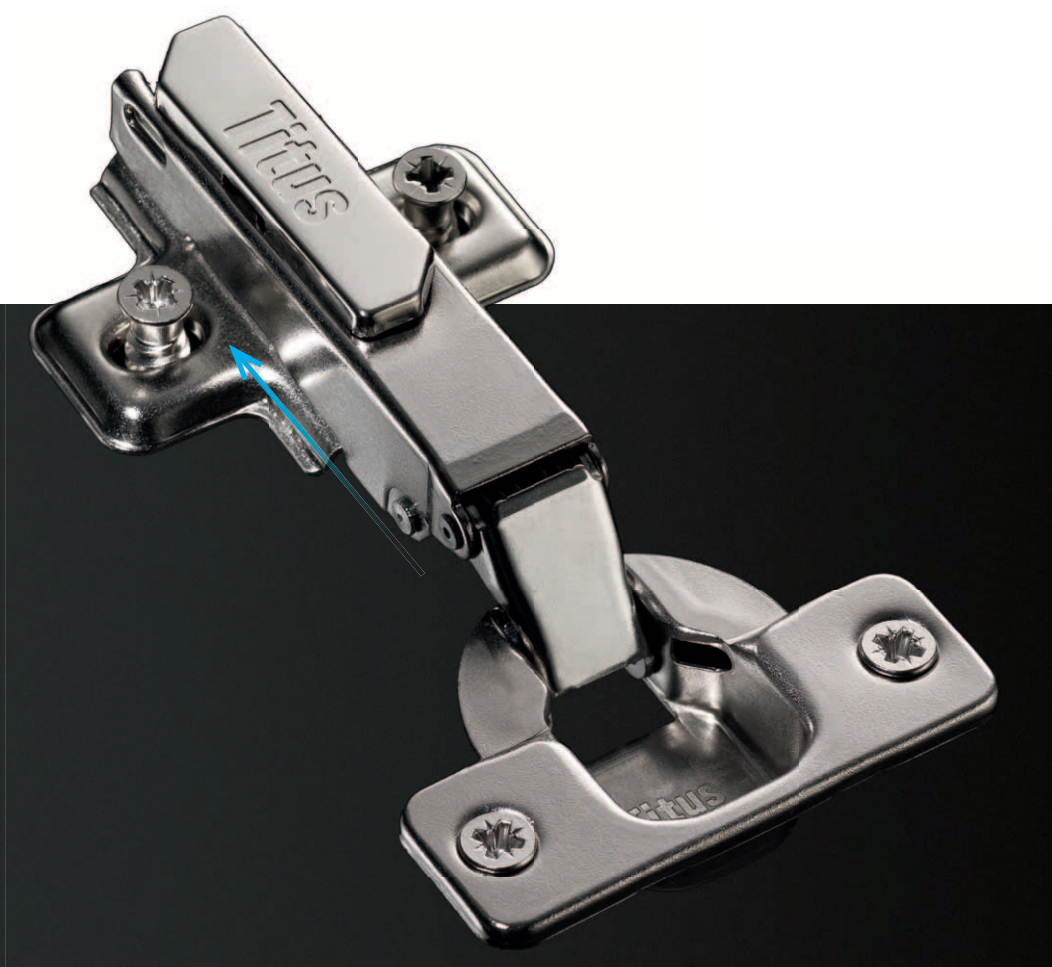

Soft closing options

- Hinge integrated
- Add-on with Glissando ready hinge cup
- Stand-alone
- Rigid slide-on hinge design enables optimal performance when used with soft closer



Adjustable damping

- Adjustable damping assures perfect functioning on every door

B-type-i 110

For wood doors

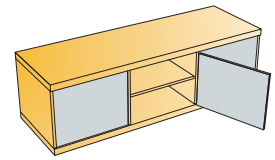
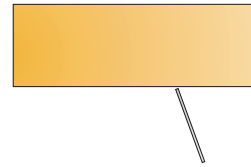

- Opening angle
- Drilling diameter for hinge cup
- Drilling depth
- Hinge on plate mounting system

110°
35mm
min. 11mm
slide-on



Technical details

Cup type	Interaxis 45mm	Interaxis 48mm
	Item number	Item number

Cranking
0mm



200 Pcs



Made of steel and plastic

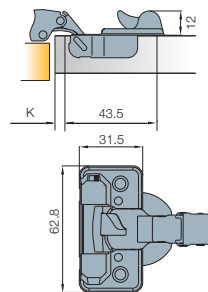

	954-0B97-050	954-0C01-050
<i>Drilling patterns for hinge cups → see page 3.15</i>		

Cranking
9mm

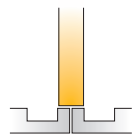

200 Pcs



Made of steel and plastic

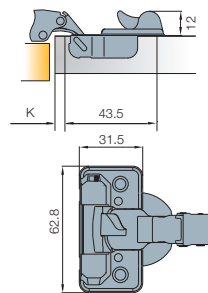

	954-0B98-050	954-0C02-050
<i>Drilling patterns for hinge cups → see page 3.15</i>		

Cranking
15mm

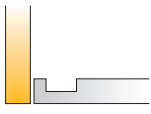

200 Pcs



Made of steel and plastic

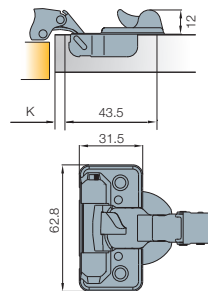

	954-0B99-050	954-0C03-050
<i>Drilling patterns for hinge cups → see page 3.15</i>		

Mounting plates



Steel mounting plates
→ see page 3.135



Zinc diecast mounting plates
→ see page 3.135

Hinge cup screws
If not pre-mounted

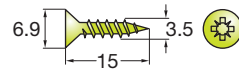

820-6308-050

10000 Pcs

Accessories



Cover caps for hinge arm
→ see page 3.151

Legend of hinge cup symbols

Screw-on ready
← screws



Damping adjustment

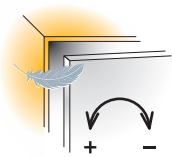

Door adjustment

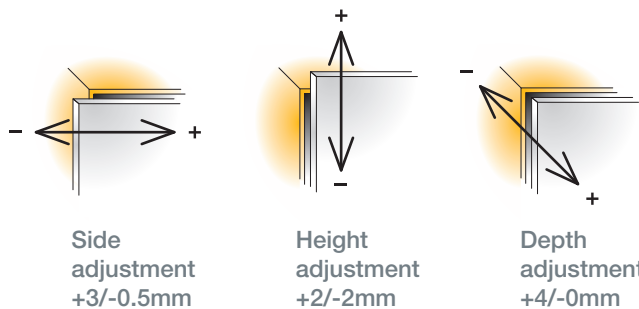

Side adjustment
+3/-0.5mm

Height adjustment
+2/-2mm

Depth adjustment
+4/-0mm

For further explanation → see page 3.25

For further explanation → see pages 3.20-3.23

Mounting details

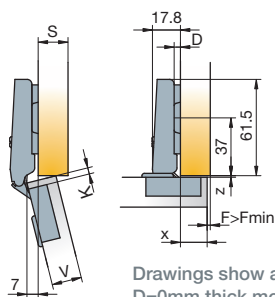

Drawings show application on D=0mm thick mounting plate

Mounting plate drilling distance

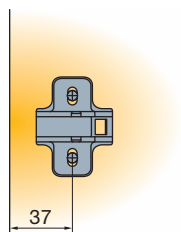

Mounting plate thickness table

For further explanation → see page 3.11

x	10	11	12	13	14	15	16	17	18
3	6	5	4	3	2	1	0	0	
K	4	6	5	4	3	2	1	0	0
5		6	5	4	3	2	1	0	D

$D=13+K-x$

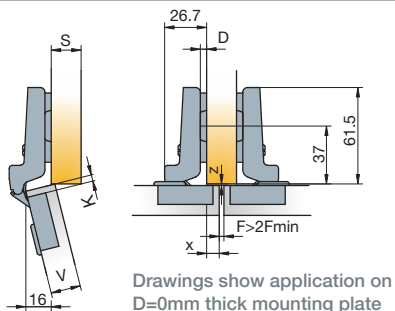

Drawings show application on D=0mm thick mounting plate

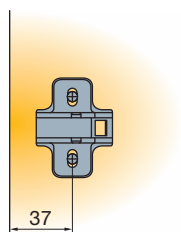

x	0	1	2	3	4	5	6	7	8	9
3		6	5	4	3	2	1	0		
K	4		6	5	4	3	2	1	0	
5	9		6	5	4	3	2	1	0	D

$D=4+K-x$

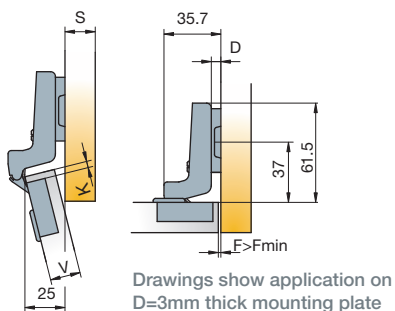

Drawings show application on D=3mm thick mounting plate

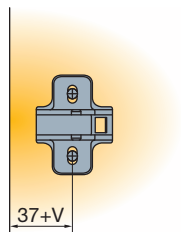

V	16	17	18	19	20	21	22
3	2	2	2	3	3	3	4
K	4	3	3	3	4	4	5
5	4	4	4	5	5	5	6

$D=-2+K+F$

Door clearance

For further explanation → see page 3.12

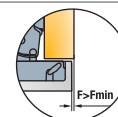

V	16	17	18	19	20	21	22
3	0.3	0.5	0.7	1.0	1.3	1.7	2.5
K	4	0.3	0.5	0.7	0.9	1.2	1.6
5	0.3	0.5	0.7	0.9	1.2	1.5	2.0

Gap $Z_{MIN}=0$

B-type-i 110/30°

30° angled application for wood doors

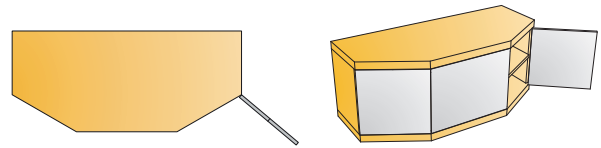

- Opening angle
- Drilling diameter for hinge cup
- Drilling depth
- Hinge on plate mounting system

110°
35mm
min. 11mm
slide-on



Technical details

	Interaxis 45mm	Interaxis 48mm
Cup type		
Item number	954-0153-650	954-0147-650

Cranking
9mm

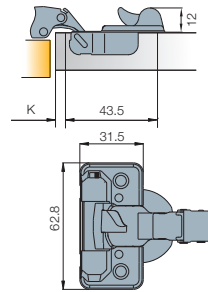
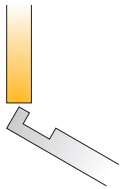

Drilling patterns for hinge cups → see page 3.15

100 Pcs

Cup made of steel and plastic, arm made of zinc

Mounting plates



Steel mounting plates
→ see page 3.135



Zinc diecast mounting plates
→ see page 3.135

Hinge cup screws

If not pre-mounted

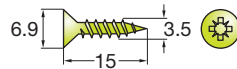

820-6308-050

10000 Pcs

Accessories



Cover caps for hinge arm
→ see page 3.151

Legend of hinge cup symbols

Screw-on ready
← screws



Damping adjustment

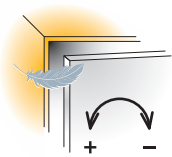

Door adjustment

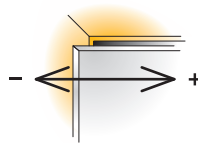

Side adjustment
+3/-0.5mm

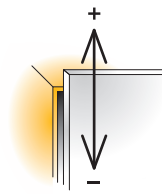

Height adjustment
+2/-2mm

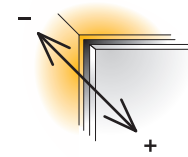

Depth adjustment
+4/-0mm

For further explanation → see page 3.25

For further explanation → see pages 3.20-3.23

Mounting details

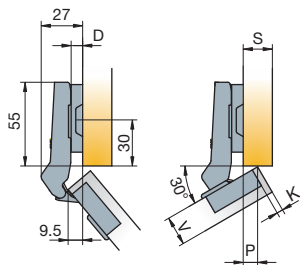

Mounting plate drilling distance

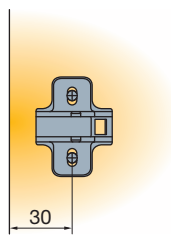

Mounting plate thickness table

For further explanation → see page 3.11

P	2.5	3.5	4.5	8.5	9.5	10.5	11.5	12.5	13.5
3	9			3	2	1	0		
K 4		9			3	2	1	0	
5			9			3	2	1	0

Drawings show application on D=3mm thick mounting plate

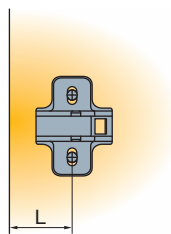
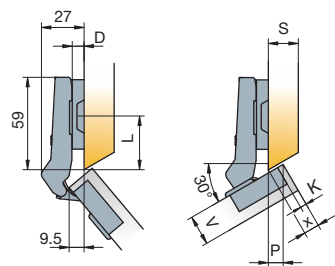

x	2	3	4	9	10	11	12	13	14	15
3	9			3	2			0		
K 4		9			3	2			0	
5			9			3	2			0

Drawings show application on D=3mm thick mounting plate

L=37 for thickness D=0
L=36 for thickness D=1
L=35 for thickness D=2
L=34 for thickness D=3
L=31 for thickness D=9

Door clearance

For further explanation → see page 3.12

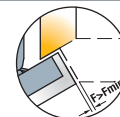

V	16	17	18	19	20	21	22
3	0.3	0.5	0.7	1.0	1.3	1.7	2.5
K 4	0.3	0.5	0.7	0.9	1.2	1.6	2.1
5	0.3	0.5	0.7	0.9	1.2	1.5	2.0

Gap Z_{MIN}=0

B-type-i 110/45°

45° angled application for wood doors

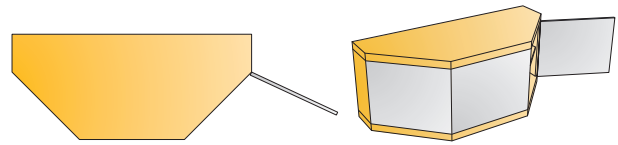
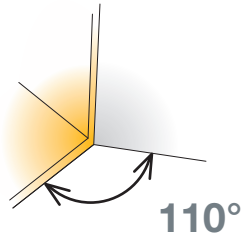

- Opening angle
- Drilling diameter for hinge cup
- Drilling depth
- Hinge on plate mounting system

110°
35mm
min. 11mm
slide-on



Technical details

	Interaxis 45mm	Interaxis 48mm
Cup type		
Item number	954-0154-650	954-0148-650

Cranking
9mm

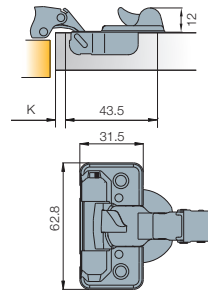
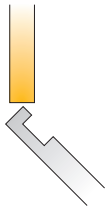

Drilling patterns for hinge cups → see page 3.15

200 Pcs

Cup made of steel and plastic, arm made of zinc

Mounting plates



Steel mounting plates
→ see page 3.135



Zinc diecast mounting plates
→ see page 3.135

Hinge cup screws

If not pre-mounted

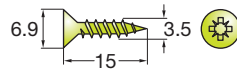

820-6308-050

10000 Pcs

Accessories



Cover caps for hinge arm
→ see page 3.151

Legend of hinge cup symbols

Screw-on ready
← screws



Damping adjustment

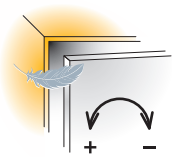

Door adjustment

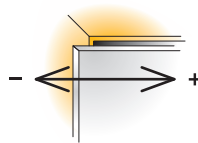

Side adjustment
+3/-0.5mm

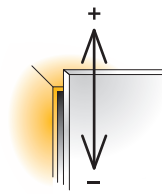

Height adjustment
+2/-2mm

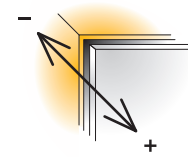

Depth adjustment
+4/-0mm

For further explanation → see page 3.25

For further explanation → see pages 3.20-3.23

Mounting details

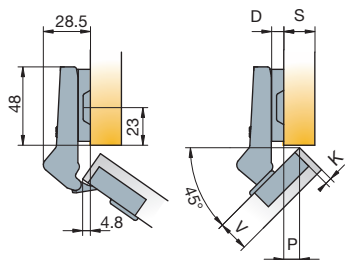

Mounting plate drilling distance

Mounting plate thickness table
For further explanation → see page 3.11

P	9	9.5	10	10.5	11	11.5	12	12.5	13.5
3	3		2		1		0		
K 4		3		2		1		0	
5				3		2		1	0 D

Drawings show application on D=3mm thick mounting plate

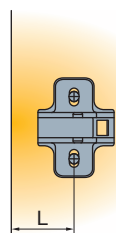
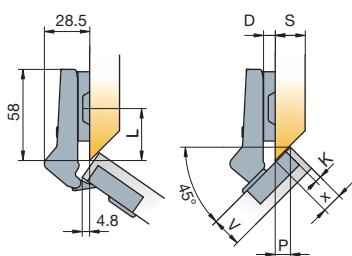

x	11.5	12.5	13	13.5	14	14.5	15	15.5	16	16.5	17	18
3	3		2			1			0			
K 4		3			2			1			0	
5					3			2		1		0 D

Drawings show application on D=3mm thick mounting plate

L=36 for thickness D=0
L=35 for thickness D=1
L=34 for thickness D=2
L=33 for thickness D=3

Door clearance

For further explanation → see page 3.12

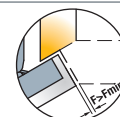

V	16	17	18	19	20	21	22
3	0.3	0.5	0.7	1.0	1.3	1.7	2.5
K 4	0.3	0.5	0.7	0.9	1.2	1.6	2.1
5	0.3	0.5	0.7	0.9	1.2	1.5	2.0 F _{MIN}

Gap Z_{MIN}=0

B-type-i 110/45°

45° angled application for wood doors

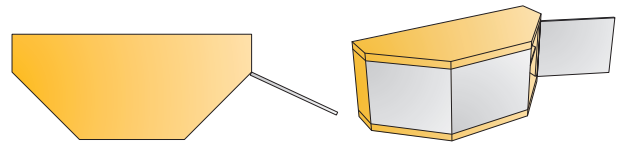
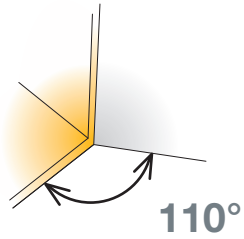

- Opening angle
- Drilling diameter for hinge cup
- Drilling depth
- Hinge on plate mounting system

110°
35mm
min. 11mm
slide-on



Technical details

	Interaxis 45mm	Interaxis 48mm
Cup type		
Item number	954-0158-650	954-0168-650

Cranking
18mm

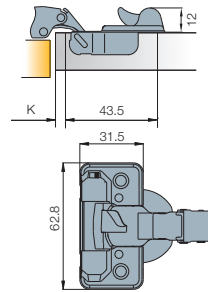
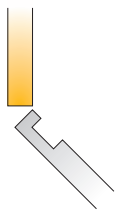

Drilling patterns for hinge cups → see page 3.15

200 Pcs

Cup made of steel and plastic, arm made of zinc

Mounting plates



Steel mounting plates
→ see page 3.135



Zinc diecast mounting plates
→ see page 3.135

Hinge cup screws

If not pre-mounted

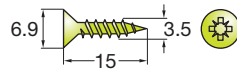

820-6308-050

10000 Pcs

Accessories



Cover caps for hinge arm
→ see page 3.151

Legend of hinge cup symbols

Screw-on ready
← screws



Damping adjustment

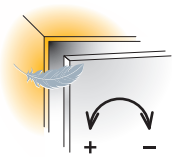

Door adjustment

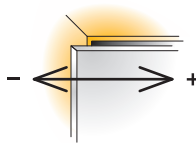

Side adjustment
+3/-0.5mm

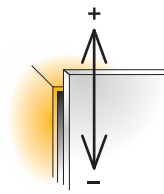

Height adjustment
+2/-2mm

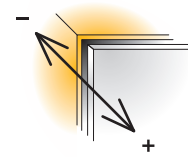

Depth adjustment
+4/-0mm

For further explanation → see page 3.25

For further explanation → see pages 3.20-3.23

Mounting details

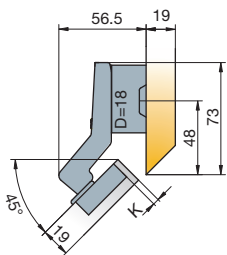

Drawings show application on D=18mm thick mounting plate

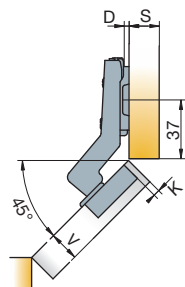

Drawings show application on D=0mm thick mounting plate

Mounting plate drilling distance

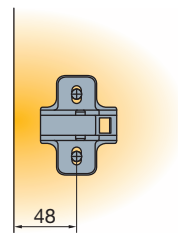

Mounting plate thickness table

For further explanation → see page 3.11

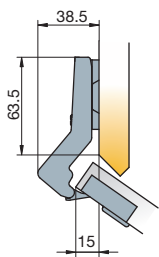

Drawings show application on D=0mm thick mounting plate

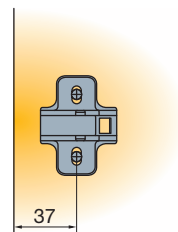
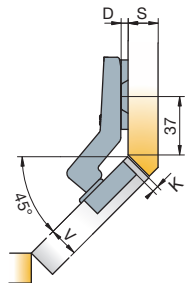

	3	0	
K	4	1	
	5	2	D

L=36 for thickness D=0
L=35 for thickness D=1
L=34 for thickness D=2
L=33 for thickness D=3

Door clearance

For further explanation → see page 3.12

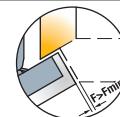

V	16	17	18	19	20	21	22	
3	0.3	0.5	0.7	1.0	1.3	1.7	2.5	
K	4	0.3	0.5	0.7	0.9	1.2	1.6	2.1
5	0.3	0.5	0.7	0.9	1.2	1.5	2.0	F _{MIN}

Gap Z_{MIN}=0

B-type-i 110/90°

For wood door cabinets with blind panels

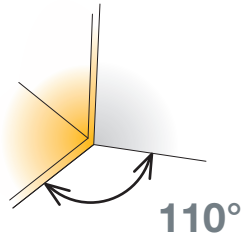
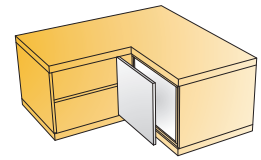

- Opening angle
- Drilling diameter for hinge cup
- Drilling depth
- Hinge on plate mounting system

110°
35mm
min. 11mm
slide-on



Technical details

Cup type	Interaxis 45mm	Interaxis 48mm
Item number		

Cranking
18mm

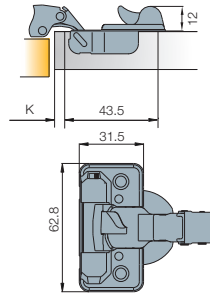

	954-0159-650	954-0149-650
--	--------------	--------------

Drilling patterns for hinge cups → see page 3.15

200 Pcs

Cup made of steel and plastic, arm made of zinc

Blind panel
mounting
plate



	244-0810-650	
15	244-0810-650	

This mounting plate can be used only with B-type-i 110/90° hinges.
Information about mounting plate symbols → see page 3.135

200 Pcs

Cup made of steel and plastic, arm made of zinc

Mounting plates



These hinges can only be used with blind panel mounting plates

Hinge cup screws
If not pre-mounted

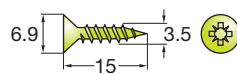

820-6308-050

10000 Pcs

Accessories



Cover caps for hinge arm
→ see page 3.151

Legend of hinge cup symbols

Screw-on ready
← screws



Damping adjustment

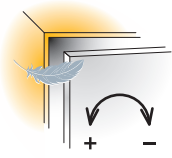

For further explanation → see page 3.25

Door adjustment

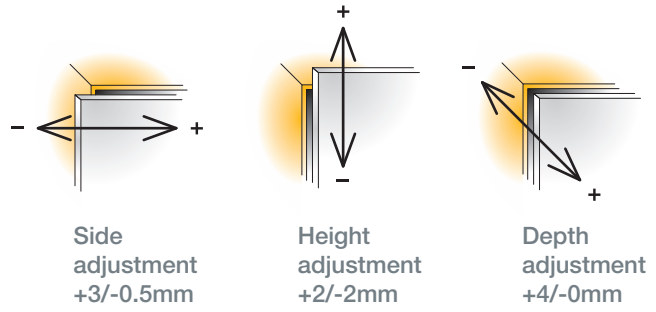

Side adjustment
+3/-0.5mm

Height adjustment
+2/-2mm

Depth adjustment
+4/-0mm

For further explanation → see pages 3.20-3.23

Mounting details

Mounting plate drilling distance

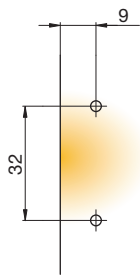
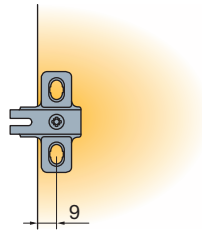
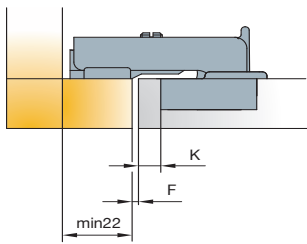

Door clearance

For further explanation → see page 3.12

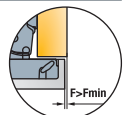

V	16	17	18	19	20	21	22	
3	0.3	0.5	0.7	1.0	1.3	1.7	2.5	
K	4	0.3	0.5	0.7	0.9	1.2	1.6	2.1
5	0.3	0.5	0.7	0.9	1.2	1.5	2.0	F _{MIN}

Gap Z_{MIN}=0

B-type 110

For wood doors

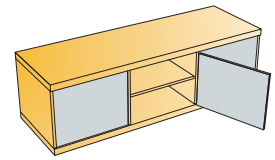
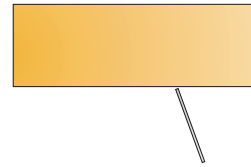

- Opening angle
- Drilling diameter for hinge cup
- Drilling depth
- Hinge on plate mounting system

110°
35mm
min. 11.5mm
slide-on



Technical details

Cup type	Interaxis 45mm	Interaxis 48mm	Interaxis 52mm
	Item number	Item number	Item number

Cranking
0mm

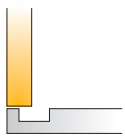

200 Pcs

Made of steel

	248-0G54-050	248-0G49-050	248-0G59-050
	248-0G79-050	248-0K40-050	248-0L63-050

Drilling patterns for hinge cups → see page 3.15

Cranking
9mm

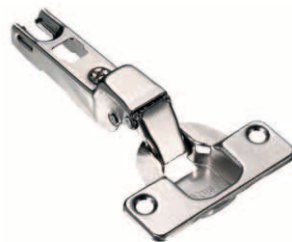
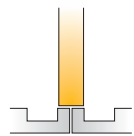

200 Pcs

Made of steel

	248-0G55-050	248-0G50-050	248-0G60-050
	248-0G80-050	248-0K76-050	

Drilling patterns for hinge cups → see page 3.15

Cranking
15mm

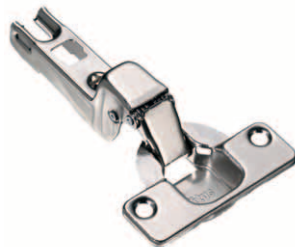
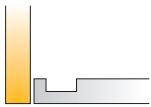

200 Pcs

Made of steel

	248-0G56-050	248-0G51-050	248-0G61-050
	248-0G81-050	248-0L04-050	

Drilling patterns for hinge cups → see page 3.15

Mounting plates



Steel mounting plates
→ see page 3.135



Zinc diecast mounting plates
→ see page 3.135

Hinge cup screws If not pre-mounted

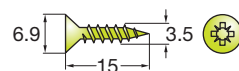

820-6308-050

10000 Pcs

Legend of hinge cup symbols

Screw-on ready
← screws

Machine insertion ready



Door adjustment

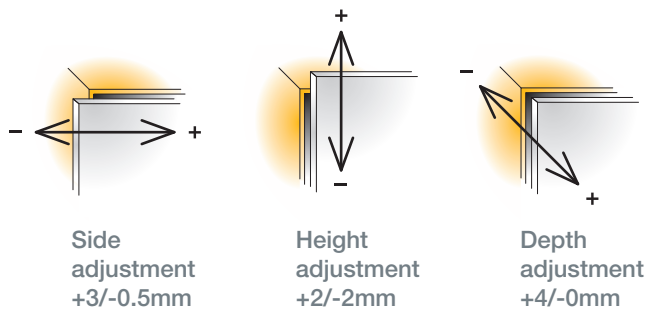

For further explanation → see pages 3.20-3.23

Mounting details

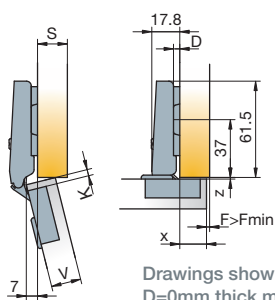

Mounting plate drilling distance

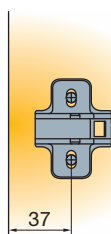

Mounting plate thickness table

For further explanation → see page 3.11

x	10	11	12	13	14	15	16	17	18
3	6	5	4	3	2	1	0	0	
K	4	6	5	4	3	2	1	0	0
5		6	5	4	3	2	1	0	D

$D=13+K-x$

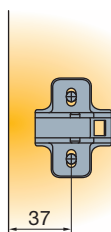
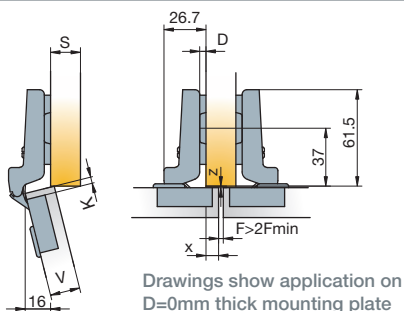

x	0	1	2	3	4	5	6	7	8	9
3		6	5	4	3	2	1	0		
K	4		6	5	4	3	2	1	0	
5	9		6	5	4	3	2	1	0	D

$D=4+K-x$

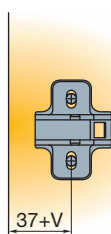
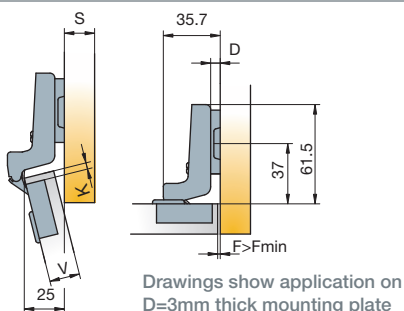

V	16	17	18	19	20	21	22
3	2	2	2	3	3	3	4
K	4	3	3	3	4	4	5
5	4	4	4	5	5	5	6

$D=-2+K+F$

Soft closing systems



Accessories



Door clearance

For further explanation → see page 3.12

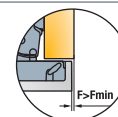

V	16	17	18	19	20	21	22
3	0.3	0.5	0.7	1.0	1.3	1.7	2.5
K	4	0.3	0.5	0.7	0.9	1.2	1.6
5	0.3	0.5	0.7	0.9	1.2	1.5	2.0

Gap $Z_{MIN}=0$

B-type 110/30°

30° angled application for wood doors

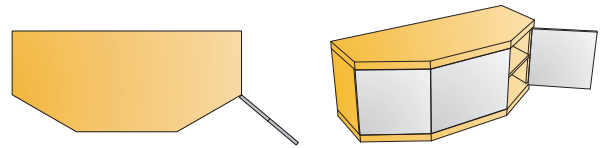
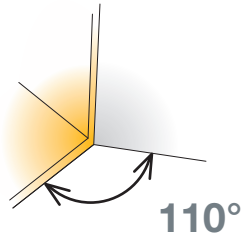

- Opening angle 110°
- Drilling diameter for hinge cup 35mm
- Drilling depth 11.5mm
- Hinge on plate mounting system slide-on



Technical details

	Interaxis 45mm	Interaxis 48mm	Interaxis 52mm
Cup type	Item number	Item number	Item number
	248-0G57-050	248-0G52-050	248-0G62-050
	248-0G82-050	248-0L72-050	

Drilling patterns for hinge cups → see page 3.15

Cranking
9mm

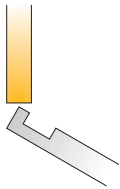

200 Pcs

Cup made of steel, arm made of zinc

Mounting plates



Steel mounting plates
→ see page 3.135



Zinc diecast mounting plates
→ see page 3.135

Hinge cup screws If not pre-mounted

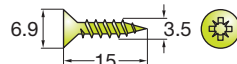

820-6308-050

10000 Pcs

Legend of hinge cup symbols

Screw-on ready
← screws

Machine insertion ready



Door adjustment

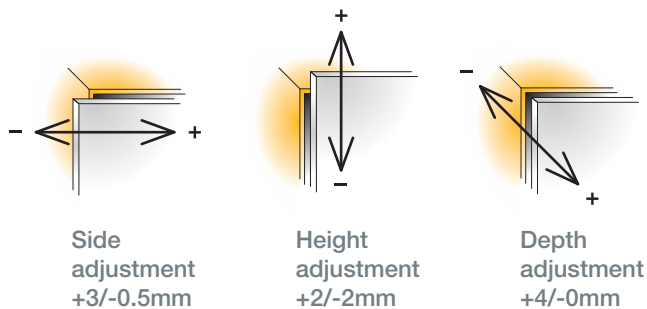

For further explanation → see pages 3.20-3.23

Mounting details

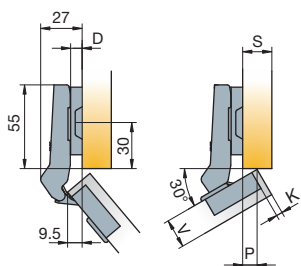

Mounting plate drilling distance

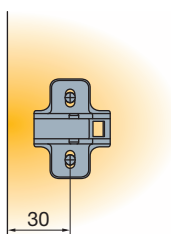

Mounting plate thickness table

For further explanation → see page 3.11

P	2.5	3.5	4.5	8.5	9.5	10.5	11.5	12.5	13.5
3	9			3	2	1	0		
K 4		9			3	2	1	0	
5			9			3	2	1	0 D

Drawings show application on D=3mm thick mounting plate

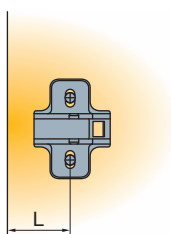
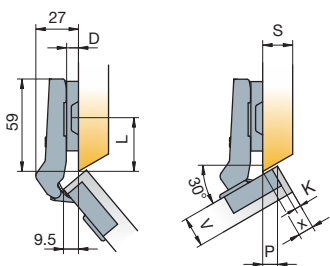

x	2	3	4	9	10	11	12	13	14	15
3	9			3	2			0		
K 4		9			3	2			0	
5			9			3	2			0 D

Drawings show application on D=3mm thick mounting plate

L=37 for thickness D=0
 L=36 for thickness D=1
 L=35 for thickness D=2
 L=34 for thickness D=3
 L=31 for thickness D=9

Soft closing systems



Accessories



Door clearance

For further explanation → see page 3.12

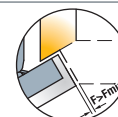

V	16	17	18	19	20	21	22
3	0.3	0.5	0.7	1.0	1.3	1.7	2.5
K 4	0.3	0.5	0.7	0.9	1.2	1.6	2.1
5	0.3	0.5	0.7	0.9	1.2	1.5	2.0 F _{MIN}

Gap Z_{MIN}=0

B-type 110/45°

45° angled application for wood doors

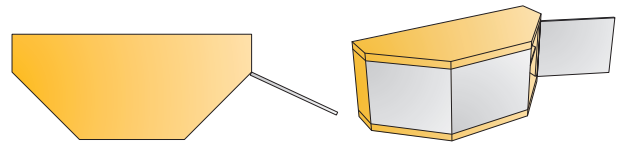
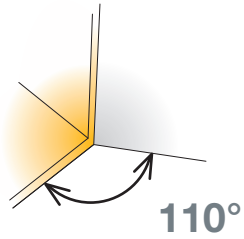

- Opening angle 110°
- Drilling diameter for hinge cup 35mm
- Drilling depth 11.5mm
- Hinge on plate mounting system slide-on



Technical details

	Interaxis 45mm	Interaxis 48mm	Interaxis 52mm
Cup type	Item number	Item number	Item number
	248-0L32-650	248-0L27-650	248-0M83-050
	248-0N38-050	248-0L71-050	

Drilling patterns for hinge cups → see page 3.15

Cranking
9mm

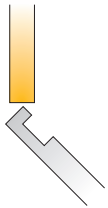

200 Pcs

Cup made of steel, arm made of zinc

Mounting plates



Steel mounting plates
→ see page 3.135



Zinc diecast mounting plates
→ see page 3.135

Hinge cup screws If not pre-mounted

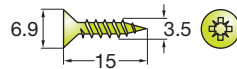

820-6308-050

10000 Pcs

Legend of hinge cup symbols

Screw-on ready
← screws

Machine insertion ready



Door adjustment

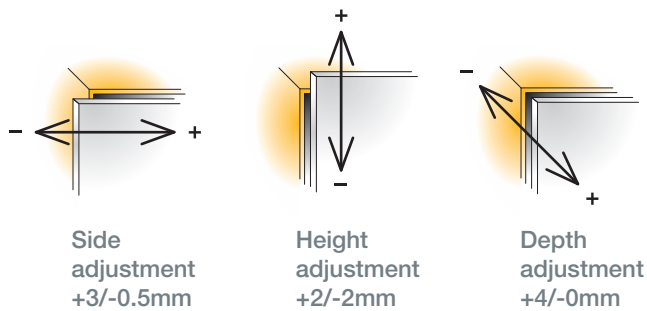

For further explanation → see pages 3.20-3.23

Mounting details

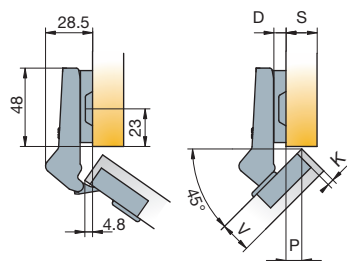

Drawings show application on D=3mm thick mounting plate

Mounting plate drilling distance

Mounting plate thickness table
For further explanation → see page 3.11

P	9	9.5	10	10.5	11	11.5	12	12.5	13.5
3	3		2		1		0		
K 4		3		2		1		0	
5				3		2		1	0 D

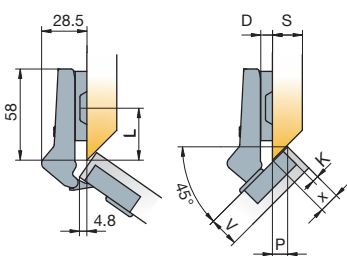

Drawings show application on D=3mm thick mounting plate

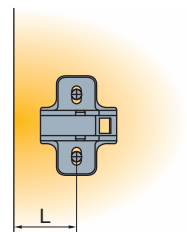

x	11.5	12.5	13	13.5	14	14.5	15	15.5	16	16.5	17	18
3	3		2			1			0			
K 4		3			2			1			0	
5					3			2		1		0 D

L=36 for thickness D=0
L=35 for thickness D=1
L=34 for thickness D=2
L=33 for thickness D=3

Soft closing systems



Accessories



Door clearance

For further explanation → see page 3.12

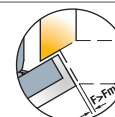

V	16	17	18	19	20	21	22
3	0.3	0.5	0.7	1.0	1.3	1.7	2.5
K 4	0.3	0.5	0.7	0.9	1.2	1.6	2.1
5	0.3	0.5	0.7	0.9	1.2	1.5	2.0 F _{MIN}

Gap Z_{MIN}=0

B-type 110/45°

45° angled application for wood doors

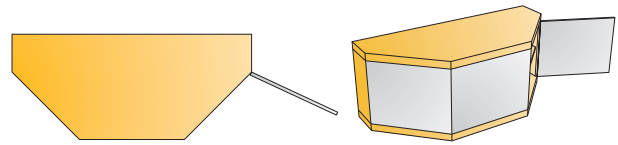
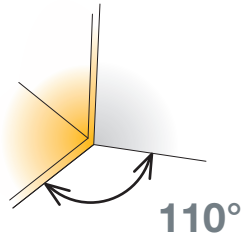

- Opening angle 110°
- Drilling diameter for hinge cup 35mm
- Drilling depth 11.5mm
- Hinge on plate mounting system slide-on



Technical details

	Interaxis 45mm	Interaxis 48mm	Interaxis 52mm
Cup type	Item number	Item number	Item number
	248-0L33-050	248-0L28-050	248-0M84-050
	248-0L46-050	248-0L70-050	

Cranking
18mm

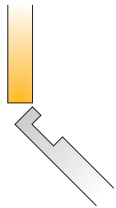

Drilling patterns for hinge cups → see page 3.15

200 Pcs

Cup made of steel, arm made of zinc

Mounting plates



Steel mounting plates
→ see page 3.135



Zinc diecast mounting plates
→ see page 3.135

Hinge cup screws

If not pre-mounted

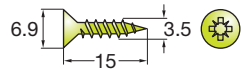

820-6308-050

10000 Pcs

Legend of hinge cup symbols

Screw-on ready
← screws

Machine insertion ready



Door adjustment

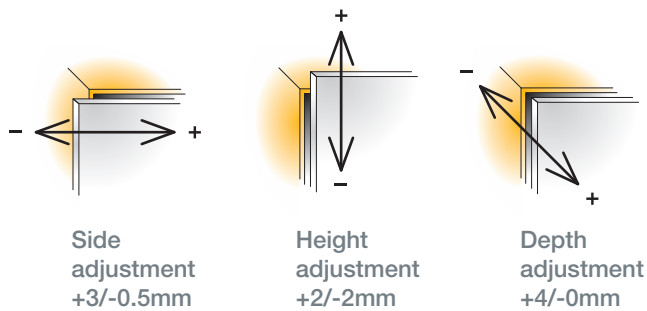

For further explanation → see pages 3.20-3.23

Mounting details

Mounting plate drilling distance

Mounting plate thickness table

For further explanation → see page 3.11

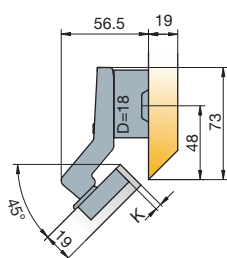

Drawings show application on D=18mm thick mounting plate

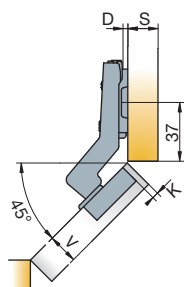

Drawings show application on D=0mm thick mounting plate

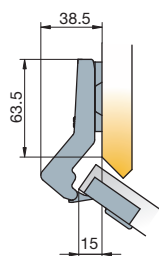
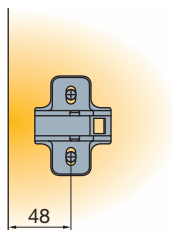

Drawings show application on D=3mm thick mounting plate

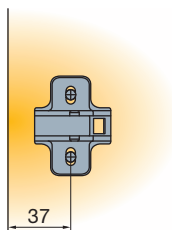
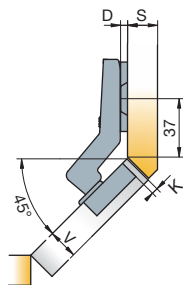

	3	0	
K	4	1	
	5	2	D

Soft closing systems



Glissando TL → see page 2.15

Accessories



Cover caps for hinge arm → see page 3.151

Door clearance

For further explanation → see page 3.12

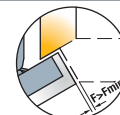

V	16	17	18	19	20	21	22	
3	0.3	0.5	0.7	1.0	1.3	1.7	2.5	
K	4	0.3	0.5	0.7	0.9	1.2	1.6	2.1
5	0.3	0.5	0.7	0.9	1.2	1.5	2.0	F _{MIN}

Gap Z_{MIN}=0

B-type 110/90°

For wood door cabinets with blind panels

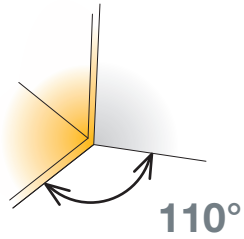
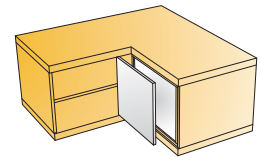

- Opening angle 110°
- Drilling diameter for hinge cup 35mm
- Drilling depth 11.5mm
- Hinge on plate mounting system slide-on



Technical details

	Interaxis 45mm	Interaxis 48mm	Interaxis 52mm
Cup type	Item number	Item number	Item number

Cranking
18mm



200 Pcs

Cup made of steel, arm made of zinc

	248-0G58-050	248-0G53-050	248-0G63-050
	248-0G83-050	248-0L73-050	

Drilling patterns for hinge cups → see page 3.15

Cranking
0mm

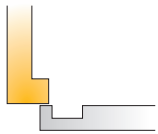

200 Pcs

Cup made of steel, arm made of zinc

	248-0255-050	248-0V66-050	248-0V53-050
--	--------------	--------------	--------------

Drilling patterns for hinge cups → see page 3.15

Cranking



200 Pcs

Made of zinc

	244-0810-650		
	11	244-0813-650	
	13	244-0C32-650	
	15	244-0P28-650	

This mounting plate can be used only with B-type 110/90° hinges.
Information about mounting plate symbols → see page 3.135

Mounting plates



These hinges can only be used with blind panel mounting plates

Hinge cup screws
If not pre-mounted

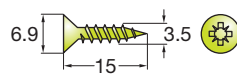

820-6308-050

10000 Pcs

Legend of hinge cup symbols

Screw-on ready
← screws

Machine insertion ready

Pre-mounted euro screws



Door adjustment

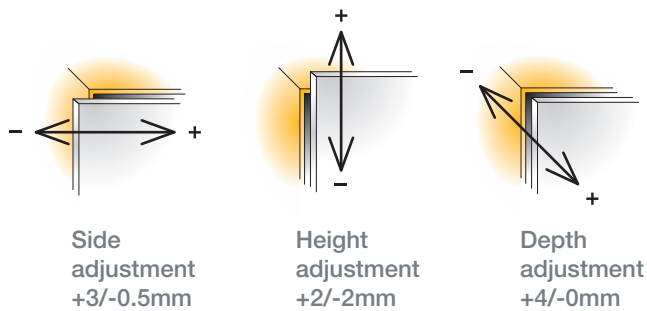

For further explanation → see pages 3.20-3.23

Mounting details

Mounting plate drilling distance

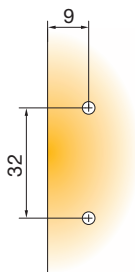
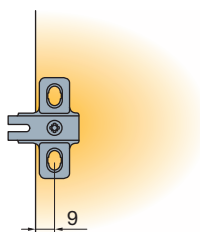
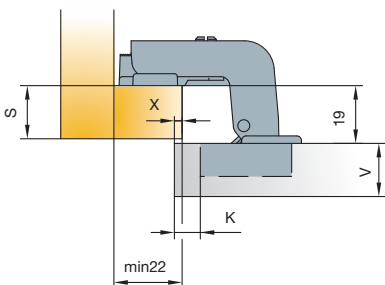
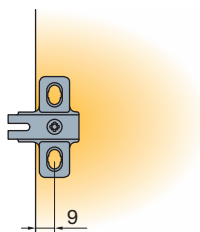
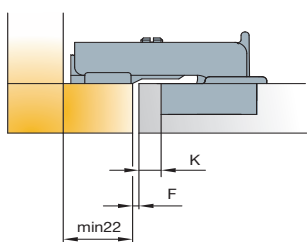

Soft closing systems



Accessories



Door clearance

For further explanation → see page 3.12

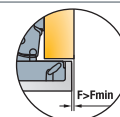

V	16	17	18	19	20	21	22	
3	0.3	0.5	0.7	1.0	1.3	1.7	2.5	
K	4	0.3	0.5	0.7	0.9	1.2	1.6	2.1
5	0.3	0.5	0.7	0.9	1.2	1.5	2.0	F _{MIN}

Gap Z_{MIN}=0

B-type 110

For aluminium frame doors

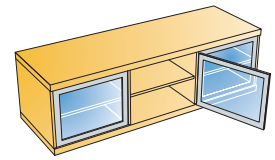
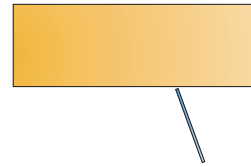
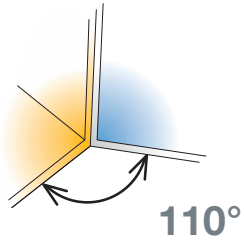

- Opening angle
- Drilling diameter for hinge cup
- Drilling depth
- Hinge on plate mounting system

110°
35mm
11.5mm
slide-on



Technical details

Cup type

Interaxis
28mm

Item number

Cranking
0mm

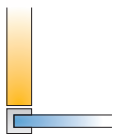

950-0T26-050

200 Pcs

Cup made of zinc, arm made of steel

Mounting plates



Steel mounting plates
→ see page 3.135



Zinc diecast mounting plates
→ see page 3.135

Door adjustment

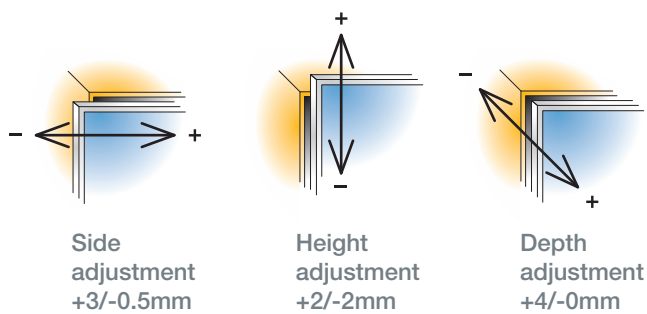

For further explanation → see pages 3.20-3.23

Mounting details

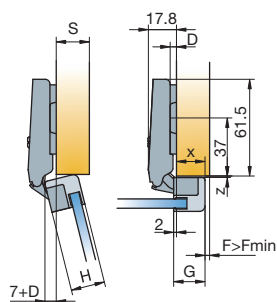

Mounting plate drilling distance

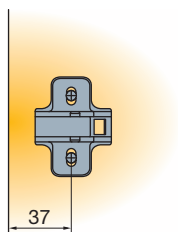

Mounting plate thickness table

For further explanation → see page 3.11

x	12	13	14	15	16	17	18
17	3	2	1	0			
18	4	3	2	1	0		
G							
19	5	4	3	2	1	0	
20	6	5	4	3	2	1	0
							D

Drawings show application on D=0mm thick mounting plate

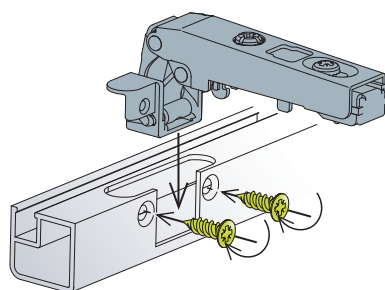
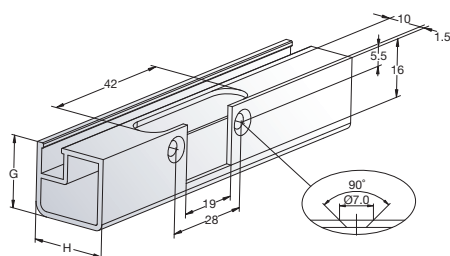

Drilling pattern for aluminium frame hinges

Screws included

Accessories



Cover caps for hinge arm
→ see page 3.151

Door clearance

For further explanation → see page 3.12

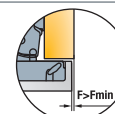

H	17	18	19	20	21	22
17	0.5	0.7	1.1	1.4	1.8	2.9
18	0.5	0.7	1.0	1.3	1.7	2.5
G						
19	0.5	0.7	0.9	1.2	1.6	2.1
20	0.5	0.7	0.9	1.2	1.5	2.0
						F _{MIN}

Gap Z_{MIN}=0.5

B-type 170

For wood doors

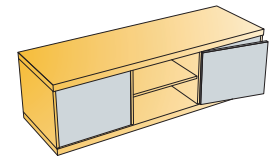
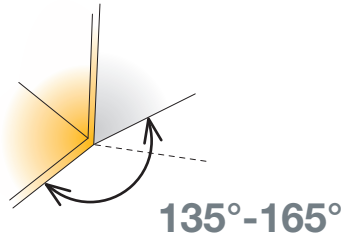

- Opening angle 135°-165°
- Drilling diameter for hinge cup 35mm
- Drilling depth 112mm
- Hinge on plate mounting system slide-on

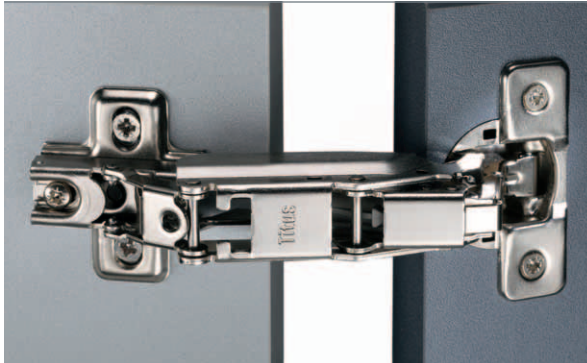

Technical details

Cup type	Interaxis 45mm	Interaxis 48mm	Interaxis 52mm
	 Item number: 248-0R10-050	 Item number: 248-0P43-050	 Item number: 248-0R11-050
	Item number: 248-0L51-050	Item number: 248-0R12-050	

Drilling patterns for hinge cups → see page 3.15

Cranking
0mm

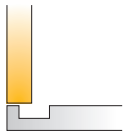

50 Pcs

Made of steel and zinc

Cranking
0mm
With adjustable opening angle



50 Pcs

Made of steel and zinc

	*248-0S05-050	*248-0S06-050	
--	---------------	---------------	--

Drilling patterns for hinge cups → see page 3.15
* Available upon special request → see page 0.3

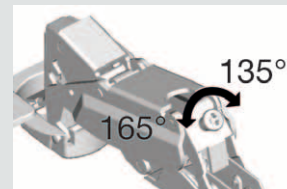

Adjustable opening angle

Mounting plates



Steel mounting plates
→ see page 3.135



Zinc diecast mounting plates
→ see page 3.135

Hinge cup screws

If not pre-mounted

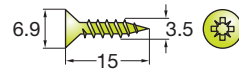

820-6308-050

10000 Pcs

Legend of hinge cup symbols

Screw-on ready
← screws

Machine insertion ready



- Enable better accessibility into cabinet interior due to the wider opening angle
- Opening angle can be easily adjusted by rotating the appropriate screw on hinge arm

Door adjustment

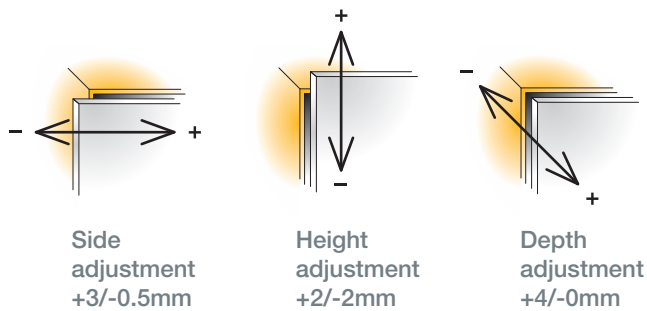

For further explanation → see pages 3.20-3.23

Mounting details

Mounting plate drilling distance

Mounting plate thickness table
For further explanation → see page 3.11

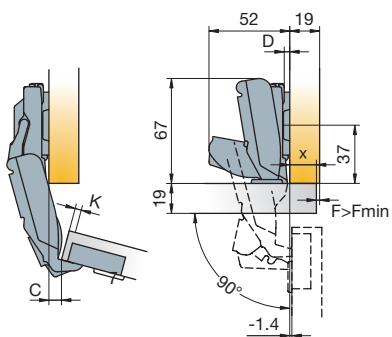

Drawings show application on D=0mm mounting plate

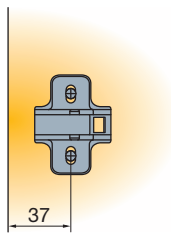

x	10	11	12	13	14	15	16	17	18	19	20
3	6	5	4	3	2	1	0				
4		6	5	4	3	2	1	0			
K 5			6	5	4	3	2	1	0		
6				6	5	4	3	2	1	0	
7					6	5	4	3	2	1	0 D

$D=13+K-x$

C value with D=0 mounting plates

K	3	4	5	6	7	
C	-9.0	-8.1	-7.1	-6.1	-5.2	D

Soft closing systems



Glissando TL 170
→ see page 2.17



Glissando CR
→ see page 2.19

Accessories



Push latch
→ see page 3.149

Door clearance

For further explanation → see page 3.12

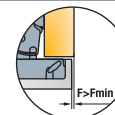

V	16	17	18	19	20	21	22	23	24
3	0.0	0.0	0.0	0.0	0.0	0.0	0.0	0.0	0.0
4	0.0	0.0	0.0	0.0	0.0	0.0	0.0	0.0	0.0
K 5	0.0	0.0	0.0	0.0	0.0	0.0	0.0	0.0	0.0
6	0.0	0.0	0.0	0.0	0.0	0.0	0.0	0.0	2.6
7	0.0	0.0	0.0	0.0	0.0	0.0	0.0	0.0	5.1 F _{MIN}

Gap Z_{MIN}=0

B-type 170

For wood doors

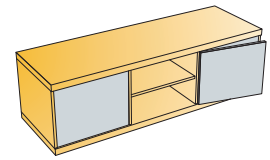
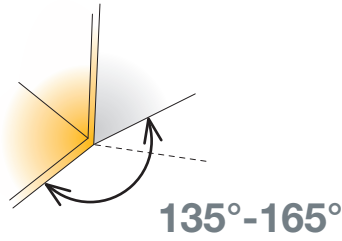

- Opening angle
- Drilling diameter for hinge cup
- Drilling depth
- Hinge on plate mounting system

135°-165°
35mm
112mm
slide-on

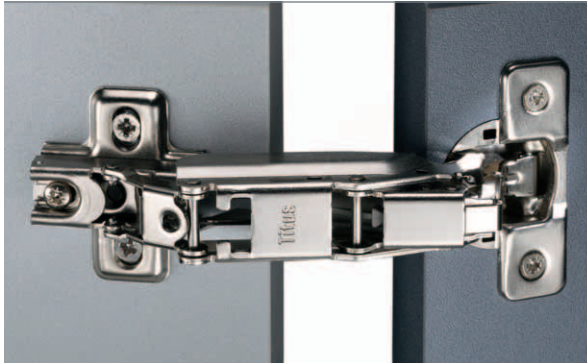

	Interaxis 45mm	Interaxis 48mm	Interaxis 52mm
Cup type	Item number	Item number	Item number
	248-0160-050	248-0161-050	

Cranking
9mm

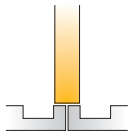

Drilling patterns for hinge cups → see page 3.15

50 Pcs

Made of steel and zinc

Mounting plates



Steel mounting plates
→ see page 3.135



Zinc diecast mounting plates
→ see page 3.135

Hinge cup screws If not pre-mounted

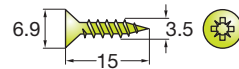

820-6308-050

10000 Pcs

Legend of hinge cup symbols

Screw-on ready
← screws



- Enable better accessibility into cabinet interior due to the wider opening angle
- Opening angle can be easily adjusted by rotating the appropriate screw on hinge arm

Door adjustment

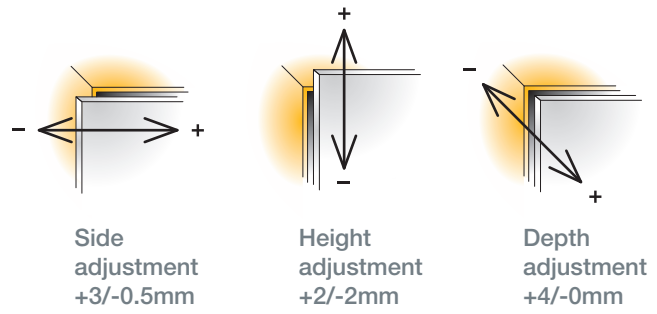

For further explanation → see pages 3.20-3.23

Mounting details

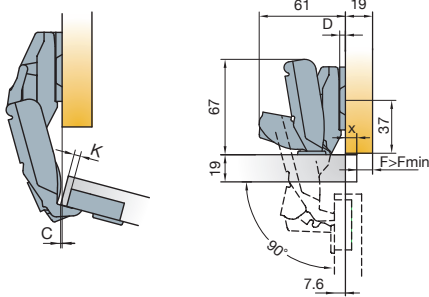

Drawings show application on D=0mm thick mounting plate

Mounting plate drilling distance

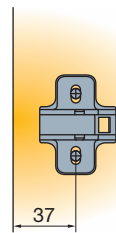

Mounting plate thickness table

For further explanation → see page 3.11

x	1	2	3	4	5	6	7	8	9	10	11
3	6	5	4	3	2	1	0				
4		6	5	4	3	2	1	0			
K 5			6	5	4	3	2	1	0		
6				6	5	4	3	2	1	0	
7					6	5	4	3	2	1	0

$D=4+K-x$

C value with D=0 mounting plates

K	3	4	5	6	7	
C	0	0.9	1.9	2.9	3.8	D

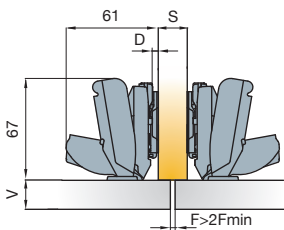

Drawings show application on D=0mm thick mounting plate

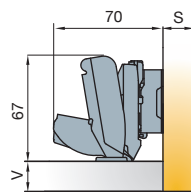

Drawings show application on D=9mm thick mounting plate

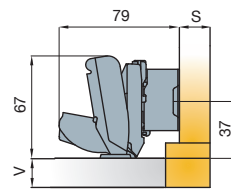

Drawings show application on D=18mm thick mounting plate

Soft closing systems



Glissando TL 170
→ see page 2.17



Glissando CR
→ see page 2.19

Accessories



Push latch
→ see page 3.149

Door clearance

For further explanation → see page 3.12

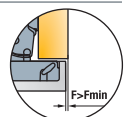

V	16	17	18	19	20	21	22	23	24
3	0.0	0.0	0.0	0.0	0.0	0.0	0.0	0.0	0.0
4	0.0	0.0	0.0	0.0	0.0	0.0	0.0	0.0	0.0
K 5	0.0	0.0	0.0	0.0	0.0	0.0	0.0	0.0	0.0
6	0.0	0.0	0.0	0.0	0.0	0.0	0.0	0.0	2.6
7	0.0	0.0	0.0	0.0	0.0	0.0	0.0	0.0	5.1 F _{MIN}

Gap Z_{MIN}=0

B-type for Pie-cut Corner Cabinet

For wood doors

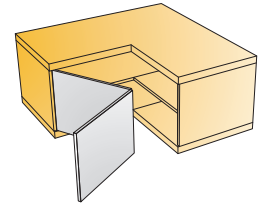

- Drilling diameter for hinge cup 35mm
- Drilling depth 11.5mm
- Hinge on plate mounting system slide-on



	Interaxis 45mm	Interaxis 48mm
Cup type	Item number	Item number
	248-0T81-050	248-0T80-050
	248-0U13-050	248-0U14-050

Corner cabinet

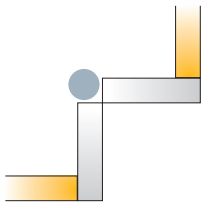

Drilling patterns for hinge cups → see page 3.15

100 Pcs

Cup made of steel, arm made of zinc

Mounting plates



Steel mounting plates
→ see page 3.135



Zinc diecast mounting plates
→ see page 3.135

Hinge cup screws If not pre-mounted

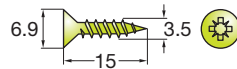

820-6308-050

10000 Pcs

Legend of hinge cup symbols

Screw-on ready
← screws

Machine insertion ready



Door adjustment

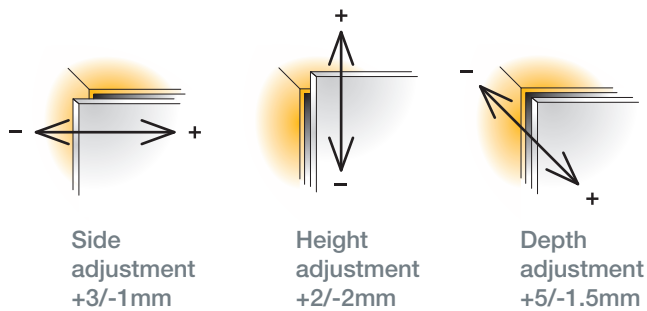

For further explanation → see pages 3.20-3.23

Mounting details

Mounting plate drilling distance

Adjustments

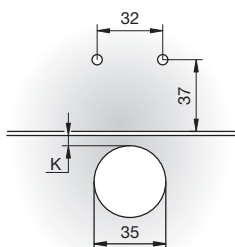
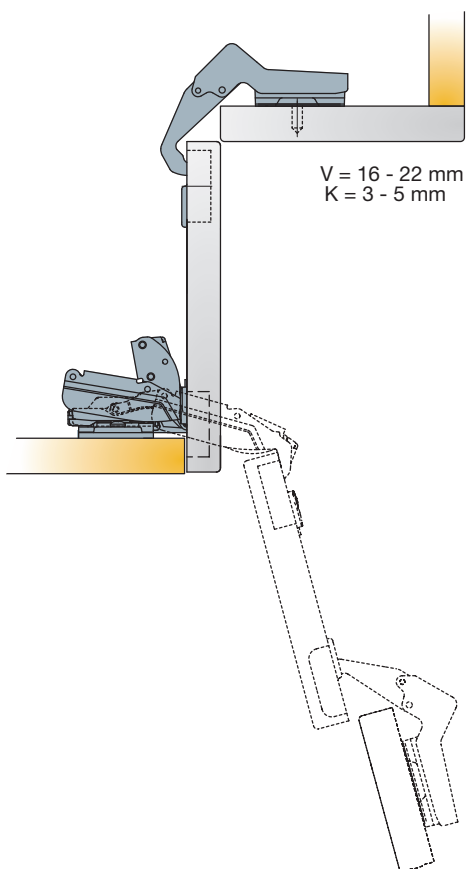

Any B-type mounting plate of thickness $D=0$ can be used.

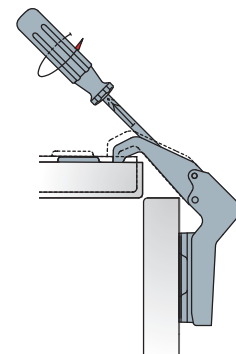

The diagonal adjustment is made by rotating the appropriate screw as shown on the drawing.

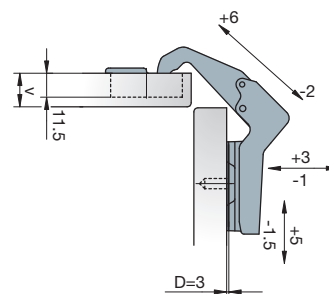

Accessories



Cover caps for hinge arm
→ see page 3.151

B-type

Flap door hinge

For wood doors

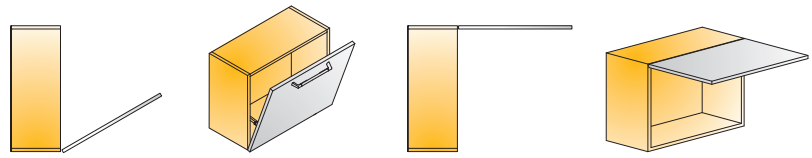

- Opening angle
- Drilling diameter for hinge cup
- Drilling depth
- Hinge on plate mounting system

90°
35mm
11.5mm
slide-on

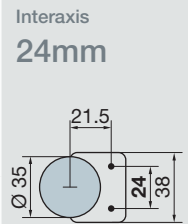

Cup type

Item number

Cranking
0mm



left



926-0A26-050

right



926-0A27-050

200 Pcs

Cup made of steel

Mounting plates



Steel mounting plates
→ see page 3.135



Zinc diecast mounting plates
→ see page 3.135

Hinge cup screws
If not pre-mounted

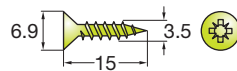

820-6308-050

10000 Pcs

Legend of hinge cup symbols

Screw-on ready
← screws



- To be used with flap stay mechanisms
- Mounted on the cabinet side
- Standard drillings

Door adjustment

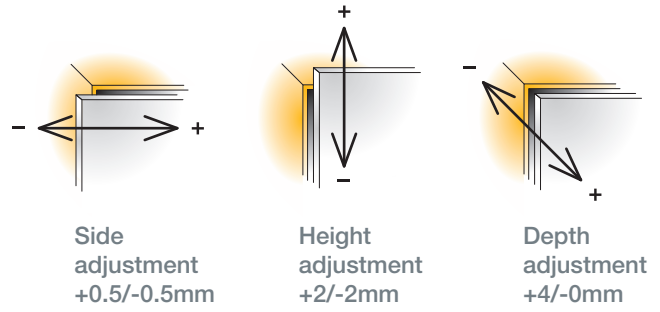

For further explanation → see pages 3.20-3.23

Mounting details

Mounting plate thickness table

For further explanation → see page 3.11

D	0	1	2	3
B (mm)	20	21	22	23

D=mounting plate height
 $X=22.5 + K - A$ +/-2mm height adjustment

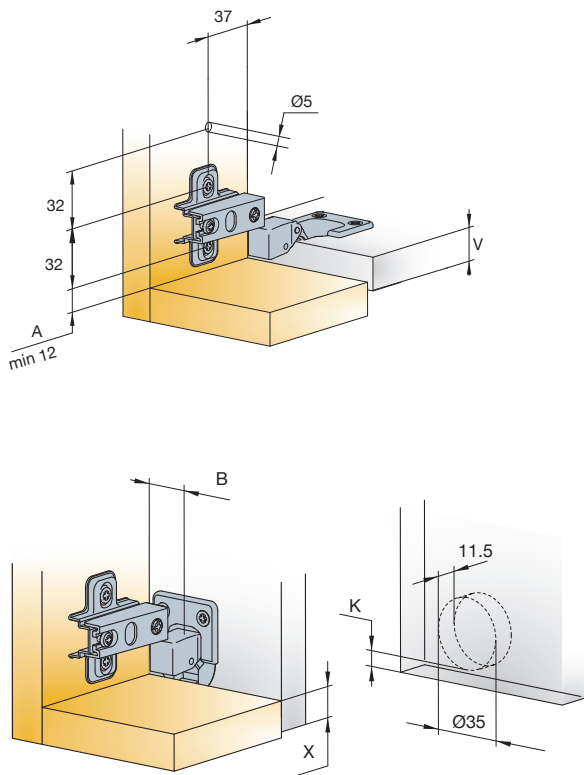

Accessories



Cover caps for hinge arm
 → see page 3.151

Door clearance

For further explanation → see page 3.12



V	16	17	18	19	20	21	22	
3	0.3	0.5	0.7	1.0	1.3	1.7	2.5	
K	4	0.3	0.5	0.7	0.9	1.2	1.6	2.1
5	0.3	0.5	0.7	0.9	1.2	1.5	2.0	F _{MIN}

Gap Z_{MIN}=0

B-type Mounting Plates

For B-type concealed hinges

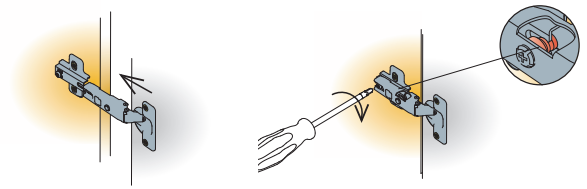

Drilling pattern

Dimensions

Steel mounting plates

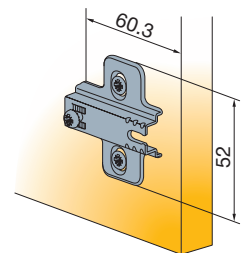
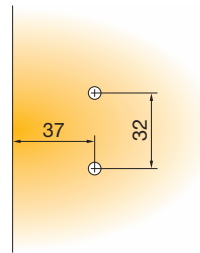
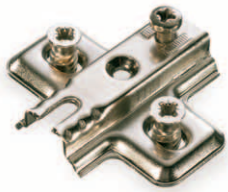

 200 Pcs Made of steel

Zinc diecast mounting plates

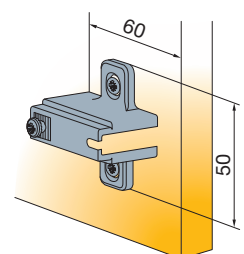
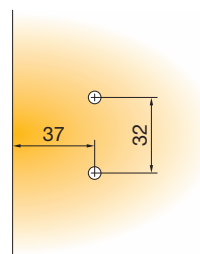

 200 Pcs Made of zinc

Fixing screws for mounting plates
If not pre-mounted

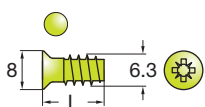

Euro screws
821-6304-050 L=11
821-6323-050 L=13
821-6332-050 L=15

 10000 Pcs

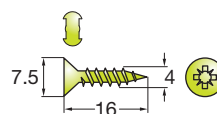

Chipboard screws
820-6328-050

 10000 Pcs

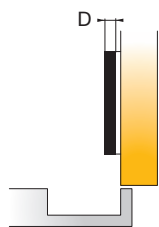

Mounting plate thickness

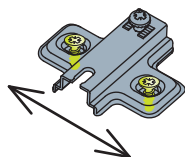

Height adjustment +/- 2mm

Mounting plate type								
Mounting plate thickness (D)								
Item number								
0mm	244-0866-050	*244-0L29-050	244-0965-050	244-0929-050	*244-0L26-050	*244-0L50-050	244-0H64-050	244-0P24-050
1mm	244-0T40-050		244-0K95-050		*244-0S65-050		244-0S67-050	
2mm	244-0T28-050		244-0K96-050		*244-0S66-050	*244-0V64-050	244-0S68-050	
3mm	244-0867-050	*244-0L39-050	244-0G19-050	244-0930-050	*244-0L98-050	*244-0L40-050	244-0H65-050	244-0P25-050
* Available upon special request → see page 0.3								
4mm	244-0L37-650		244-0K97-650				244-0M28-650	
5mm	244-0L38-650		244-0K98-650	244-0T14-650			244-0M29-650	
6mm	244-0232-650		244-0914-650			*244-0B12-650		
9mm	244-0062-650		244-0067-650	244-0P41-650				
18mm	244-0063-650		244-0068-650	244-0175-650				
* Available upon special request → see page 0.3								

Legend of mounting plate type symbols

Screw on ready for euro screws ← s crews	Screw-on ready for chipboard screws	Pre-mounted 13mm euro screws	Pre-mounted 15mm euro screws	Pre-mounted chipboard screws	Machine insertion ready	Premounted 7.5mm expanding dowels	Pre-mounted 10.5mm expanding dowels

B-type Mounting Plates

For B-type concealed hinges

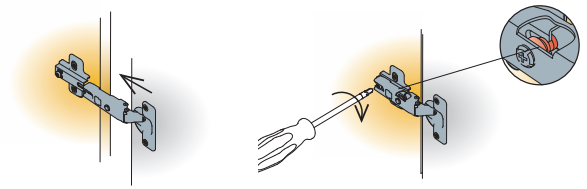

Drilling pattern

Dimensions

Steel mounting plates

- Back-to-back application

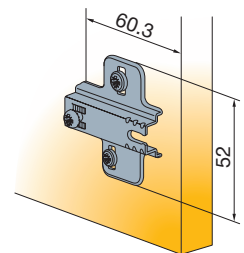
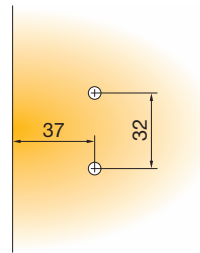

 200 Pcs Made of steel

Zinc diecast mounting plates

- For 18mm inset doors

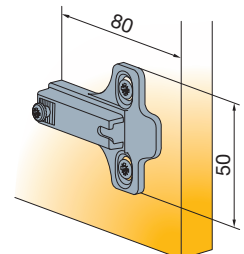
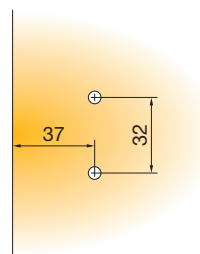

 200 Pcs Made of zinc

Fixing screws for mounting plates

If not pre-mounted

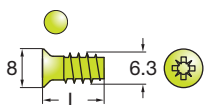

Euro screws
 821-6304-050 L=11
 821-6323-050 L=13
 821-6332-050 L=15

 10000 Pcs

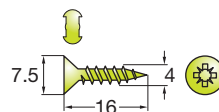

Chipboard screws
 820-6328-050

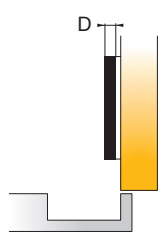

 10000 Pcs



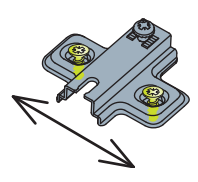

Mounting plate thickness

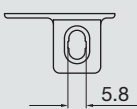
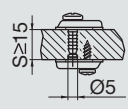
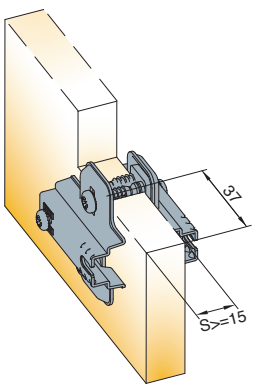
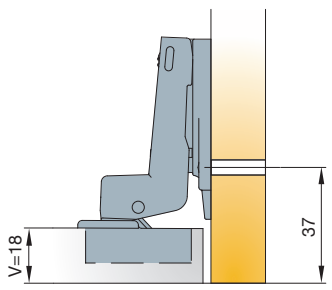

Height adjustment +/- 2mm

	Mounting plate type		
		 10.5	
	 Mounting plate thickness (D) Item number	 Item number	
	3mm		244-0V50-050
 Minimum panel thickness is 15mm.			
	2mm	244-0036-650	
 Fits standard 37mm drilling			

Legend of mounting plate type symbols

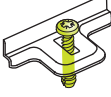
	 10.5
Screw on ready for euro screws ← screws	Pre-mounted 10.5mm expanding dowels
	

B-type Hinge Ø40

For Door Thickness up to 40mm

For wood doors

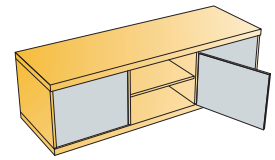
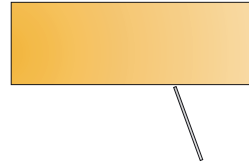
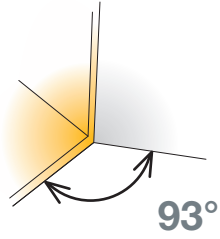

- Opening angle
- Drilling diameter for hinge cup
- Drilling depth
- Hinge on plate mounting system

93°
40mm
14.5mm
slide-on



	Interaxis 52mm
Cup type	Item number

Cranking
0mm



249-7301-050

Drilling patterns for hinge cups →
see page 3.15

200 Pcs

Made of steel

Cranking
10mm

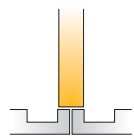

249-7302-050

Drilling patterns for hinge cups →
see page 3.15

200 Pcs

Made of steel

Mounting plates



Steel mounting plate
→ see page 3.143

Hinge cup screws

If not pre-mounted

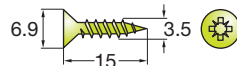

820-6308-050

10000 Pcs

Legend of hinge cup symbols

Screw-on ready
← screws

Soft closing systems



Glissando CR
→ see page 2.19

Accessories



Push latch
→ see page 3.149



Door adjustment

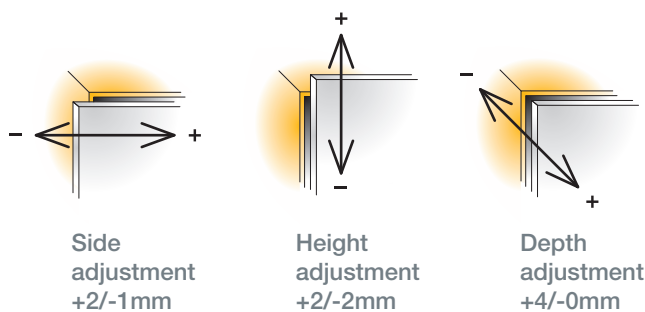

For further explanation → see pages 3.20-3.23

Mounting details

Mounting plate thickness table
For further explanation → see page 3.11

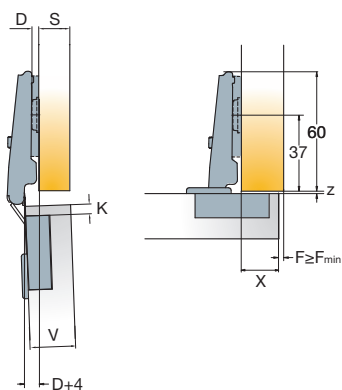

x	18	19	20	21	22	23	24	25	26	27	28	29	30	31	32	
3	8	7	6	5	4	3	2	1	0							
4		8	7	6	5	4	3	2	1	0						
5			8	7	6	5	4	3	2	1	0					
6				8	7	6	5	4	3	2	1	0				
7					8	7	6	5	4	3	2	1	0			
8						8	7	6	5	4	3	2	1	0		
9							8	7	6	5	4	3	2	1	0	
10								8	7	6	5	4	3	2	1	
11									8	7	6	5	4	3	2	
12										8	7	6	5	4	3	D

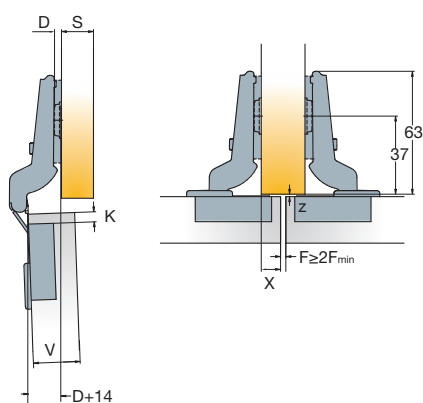

x	8	9	10	11	12	13	14	15	16	17	18	19	20	21	22	
3	8	7	6	5	4	3	2	1	0							
4		8	7	6	5	4	3	2	1	0						
5			8	7	6	5	4	3	2	1	0					
6				8	7	6	5	4	3	2	1	0				
7					8	7	6	5	4	3	2	1	0			
8						8	7	6	5	4	3	2	1	0		
9							8	7	6	5	4	3	2	1	0	
10								8	7	6	5	4	3	2	1	
11									8	7	6	5	4	3	2	
12										8	7	6	5	4	3	D

Door clearance (Fmin)

x	20	21	22	23	24	25	26	27	28	29	30	31	32	33	34	35	38	40	Z
3	0.4	0.6	0.7	0.8	1.0	1.2	1.4	1.6	1.6	2.0	2.3	2.3	2.6	2.8	3.2	6.1	9.0	10.9	0.4
4	0.4	0.6	0.7	0.8	1.0	1.2	1.4	1.6	1.6	2.0	2.3	2.3	3.5	2.8	3.1	5.3	8.2	10.2	0.4
5	0.4	0.5	0.7	0.8	1.0	1.2	1.3	1.5	1.5	2.0	2.2	2.2	2.5	2.8	3.1	4.7	7.5	9.4	0.4
6	0.4	0.5	0.7	0.8	1.0	1.1	1.3	1.5	1.5	2.0	2.2	2.2	2.4	2.7	3.0	4.1	6.8	8.7	0.4
7	0.4	0.5	0.6	0.8	1.0	1.1	1.3	1.5	1.5	1.9	2.2	2.2	2.4	2.7	3.0	3.6	6.2	8.0	0.4
8	0.4	0.5	0.6	0.8	0.9	1.1	1.3	1.5	1.5	1.9	2.1	2.1	2.4	2.6	2.9	3.5	5.6	7.4	0.4
9	0.4	0.5	0.6	0.8	0.9	1.1	1.3	1.4	1.4	1.9	2.1	2.1	2.4	2.6	2.9	3.5	5.1	6.8	0.4
10	0.4	0.5	0.6	0.8	0.9	1.1	1.2	1.4	1.4	1.8	2.1	2.1	2.3	2.6	2.8	3.4	4.6	6.3	0.4
11	0.4	0.5	0.6	0.8	0.9	1.1	1.2	1.4	1.4	1.8	2.0	2.0	2.3	2.5	2.8	3.4	4.1	5.8	0.4
12	0.4	0.5	0.6	0.7	0.9	1.0	1.2	1.4	1.4	1.8	2.0	2.0	2.3	2.5	2.8	3.3	4.1	5.4	F_{MIN} 0.4

B-type Hinge Ø40

For Door Thickness up to 40mm

For wood doors

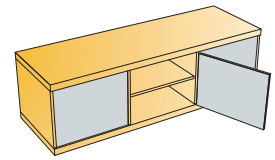
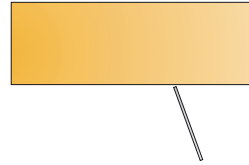
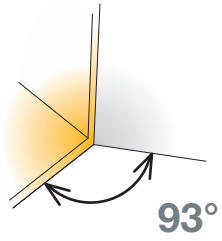

- Opening angle
- Drilling diameter for hinge cup
- Drilling depth
- Hinge on plate mounting system

93°
40mm
14.5mm
slide-on

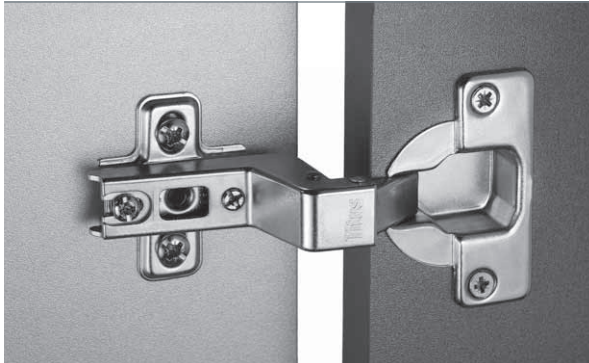

Interaxis
52mm

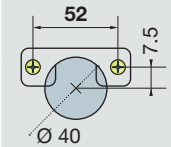

Cup type

Item number



249-7303-050

Drilling patterns for hinge cups →
see page 3.15

Cranking
18mm

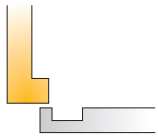

200 Pcs

Made of steel

Cranking
22mm

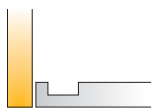

200 Pcs

Made of steel



249-7304-650

Drilling patterns for hinge cups →
see page 3.15

Mounting plates



Steel mounting plate
→ see page 3.143

Hinge cup screws
If not pre-mounted

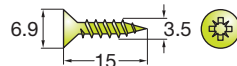

820-6308-050

10000 Pcs

Legend of hinge cup symbols



Screw-on ready
← screws



Door adjustment

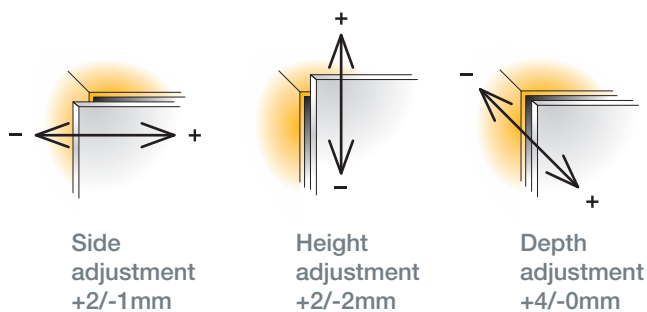

For further explanation → see pages 3.20-3.23

Mounting details

Mounting plate thickness table

For further explanation → see page 3.11

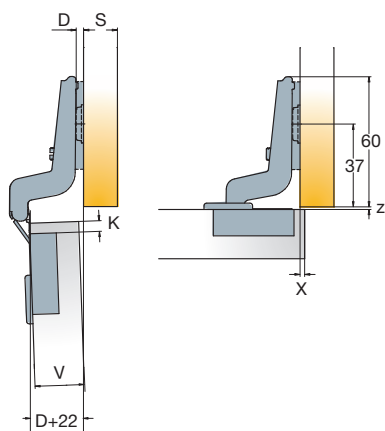

x	0	1	2	3	4	5	6	7	8	9	10	11	12	13	14	15	16	
3	8	7	6	5	4	3	2	1	0									
4		8	7	6	5	4	3	2	1	0								
5			8	7	6	5	4	3	2	1	0							
6				8	7	6	5	4	3	2	1	0						
7					8	7	6	5	4	3	2	1	0					
8						8	7	6	5	4	3	2	1	0				
9							8	7	6	5	4	3	2	1	0			
10								8	7	6	5	4	3	2	1	0		
11									8	7	6	5	4	3	2	1	0	
12										8	7	6	5	4	3	2	1	D

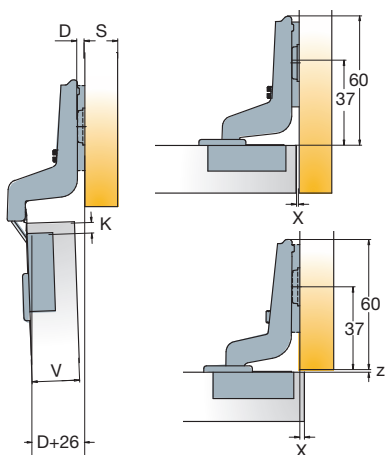

x	-2	-1	0	1	2	3	4	5	6	7	8	9	10	11	12	
3	6	5	4	3	2	1	0									
4	7	6	5	4	3	2	1	0								
5	8	7	6	5	4	3	2	1	0							
6		8	7	6	5	4	3	2	1	0						
7			8	7	6	5	4	3	2	1	0					
8				8	7	6	5	4	3	2	1	0				
9					8	7	6	5	4	3	2	1	0			
10						8	7	6	5	4	3	2	1	0		
11							8	7	6	5	4	3	2	1	0	
12								8	7	6	5	4	3	2	1	D

Door clearance (Fmin)

x	20	21	22	23	24	25	26	27	28	29	30	31	32	33	34	35	38	40	Z
3	0.4	0.6	0.7	0.8	1.0	1.2	1.4	1.6	1.6	2.0	2.3	2.3	2.6	2.8	3.2	6.1	9.0	10.9	0.4
4	0.4	0.6	0.7	0.8	1.0	1.2	1.4	1.6	1.6	2.0	2.3	2.3	3.5	2.8	3.1	5.3	8.2	10.2	0.4
5	0.4	0.5	0.7	0.8	1.0	1.2	1.3	1.5	1.5	2.0	2.2	2.2	2.5	2.8	3.1	4.7	7.5	9.4	0.4
6	0.4	0.5	0.7	0.8	1.0	1.1	1.3	1.5	1.5	2.0	2.2	2.2	2.4	2.7	3.0	4.1	6.8	8.7	0.4
7	0.4	0.5	0.6	0.8	1.0	1.1	1.3	1.5	1.5	1.9	2.2	2.2	2.4	2.7	3.0	3.6	6.2	8.0	0.4
8	0.4	0.5	0.6	0.8	0.9	1.1	1.3	1.5	1.5	1.9	2.1	2.1	2.4	2.6	2.9	3.5	5.6	7.4	0.4
9	0.4	0.5	0.6	0.8	0.9	1.1	1.3	1.4	1.4	1.9	2.1	2.1	2.4	2.6	2.9	3.5	5.1	6.8	0.4
10	0.4	0.5	0.6	0.8	0.9	1.1	1.2	1.4	1.4	1.8	2.1	2.1	2.3	2.6	2.8	3.4	4.6	6.3	0.4
11	0.4	0.5	0.6	0.8	0.9	1.1	1.2	1.4	1.4	1.8	2.0	2.0	2.3	2.5	2.8	3.4	4.1	5.8	0.4
12	0.4	0.5	0.6	0.7	0.9	1.0	1.2	1.4	1.4	1.8	2.0	2.0	2.3	2.5	2.8	3.3	4.1	5.4	F _{MIN} 0.4

B-type Mounting Plates

For Hinge Ø40

Slide-on hinge to plate mounting

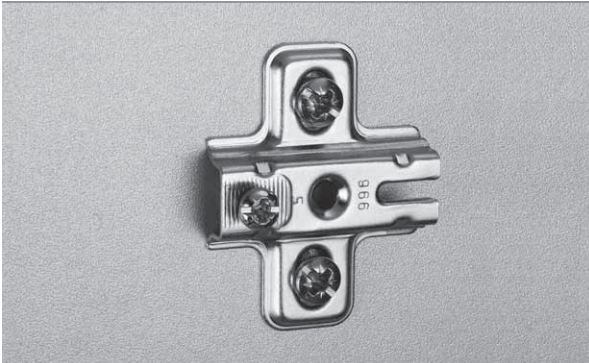
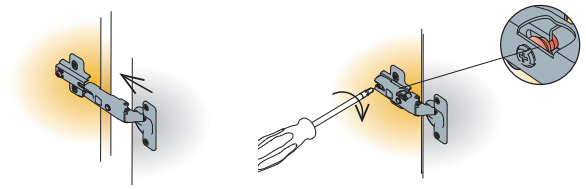

Steel mounting plates

Drilling pattern

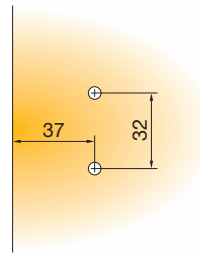
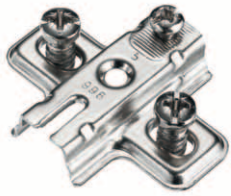

Fixing screws for mounting plates
If not pre-mounted

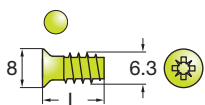

Euro screws
821-6323-050 L=13
821-6332-050 L=15

10000 Pcs

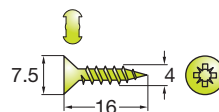

Chipboard screws
820-6328-050

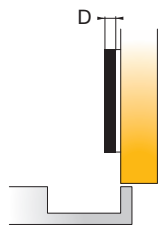

10000 Pcs

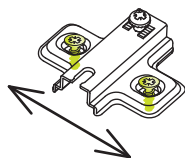

Mounting plate thickness

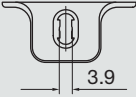

Height adjustment +/- 2mm

Mounting plate type		 14	
Mounting plate thickness (D)			
	Item number	Item number	
4mm	244-7324-050	244-7314-050	
5mm	244-7325-050	244-7315-050	
6mm	244-7326-050	244-7316-050	
8mm	244-7328-050	244-7318-050	

Legend of mounting plate type symbols



Screw-on ready for chipboard screws



Pre-mounted 14mm euro screws

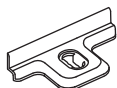

Wide Angle Hinge

For wood doors

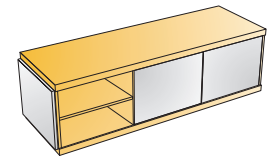
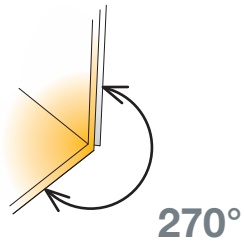

- Opening angle
- Drilling diameter for hinge cup
- Drilling depth
- Hinge on plate mounting system

270°
35mm
12.5mm
key-hole



Nickel plated



200 Pcs

Made of zinc

Mounting plate
Nickel plated



200 Pcs

Made of zinc

Mounting plates



This mounting plate can be used only with Wide angle hinge. Information about mounting plate symbols → see page 3.135

Hinge cup screws
If not pre-mounted

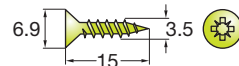

820-6308-050

10000 Pcs

Legend of hinge cup symbols

- Screw-on ready ← screws
- Machine insertion ready
- Pre-mounted euro screws



Technical details

Cup type

With spring

Item number



241-0043-650



241-0050-650

D=0mm



244-0907-650



13 244-0848-650

D=2mm



244-0D99-650



13 244-0E02-650

D=6mm



244-0D47-650



13 244-0D46-650

Door adjustment

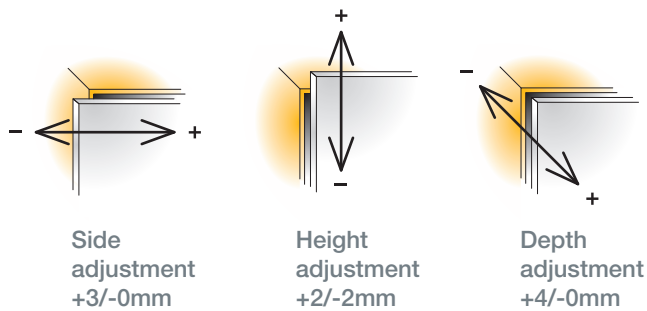

For further explanation → see pages 3.20-3.23

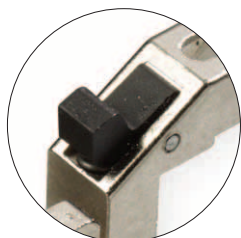

With spring

Mounting details

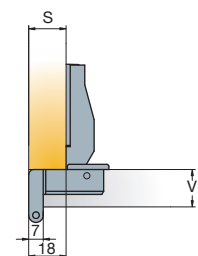

Drawings show application on D=0 mounting plate and S=18 side panel.

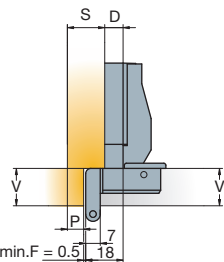

Drawings show application on D=6mm thick mounting plate

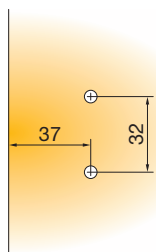

Mounting plate drilling distance

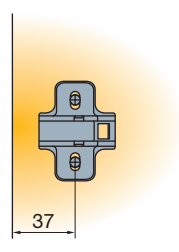
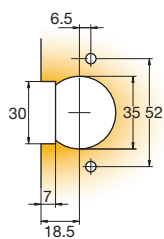
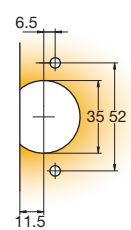

Mounting plate drilling distance

Mounting plate thickness table

For further explanation → see page 3.11

S	16	17	18	19	20	21	22	23	24
0	2		0						
1		2		0					
2			2		0				
3				2		0			
4	6				2		0		
5		6				2		0	
P 6			6				2		0
7				6				2	
8					6				2
9						6			
10							6		
11								6	
12									6

Door thickness



For correct opening the door thickness should not exceed (V_{MAX}) 21mm

Refrigerator Cabinet Door Hinge

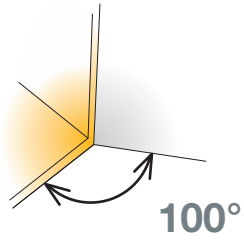

- Opening angle 110°
- Drilling diameter for hinge cup 35mm
- Drilling depth 11.5mm
- Hinge on plate mounting system key-hole

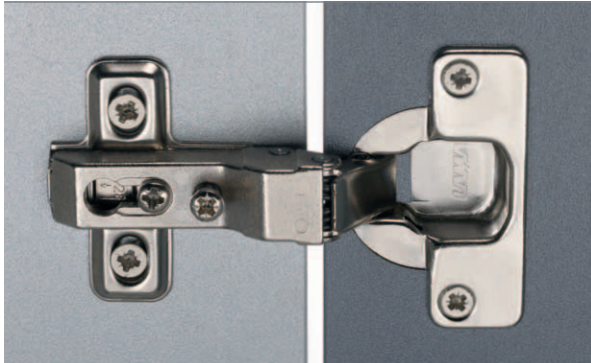

Technical details

Cup type	Interaxis 45mm	Interaxis 48mm
	Item number	Item number
	248-0R09-050	248-0K10-050
		248-0M41-050

Drilling patterns for hinge cups → see page 3.15

Cranking
0mm

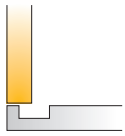

200 Pcs

Cup made of steel, arm made of zinc

Steel mounting plates

D=0mm

	244-0655-050	
	13	244-0846-050

Information about mounting plate symbols
→ see page 3.135



500 Pcs

Made of steel

Mounting plates



This hinge can be mounted only with key-hole mounting plates.

Hinge cup screws
If not pre-mounted

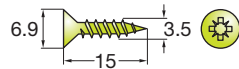

820-6308-050

10000 Pcs

Legend of hinge cup symbols

Screw-on ready
← screws

Machine insertion ready

Pre-mounted euro screws

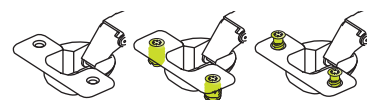

- Flat hinge arm allows minimal required gap between refrigerator and cabinet side.

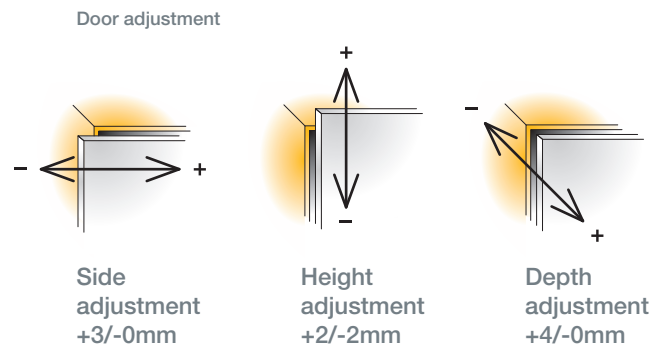

For further explanation → see pages 3.20-3.23

Mounting details

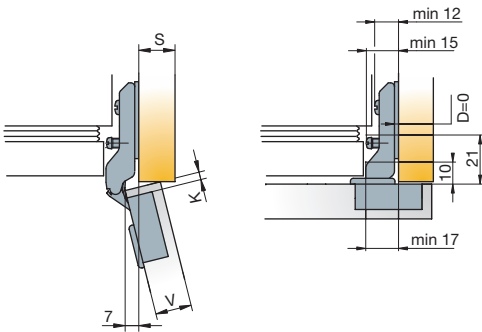

Drawings show application on D=0mm thick mounting plate

Mounting plate drilling distance

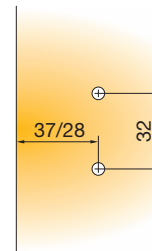
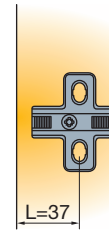

Door clearance

For further explanation → see page 3.12



V	16	17	18	19	20	21	22
3	0.3	0.5	0.7	1.0	1.3	1.7	2.5
K 4	0.3	0.5	0.7	0.9	1.2	1.6	2.1
5	0.3	0.5	0.7	0.9	1.2	1.5	2.0

Gap $Z_{MIN}=0$

Push Latch

For wood doors and drawers

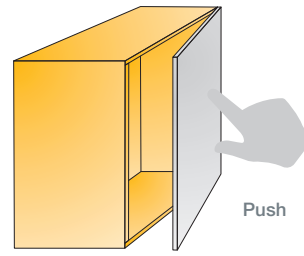

Push

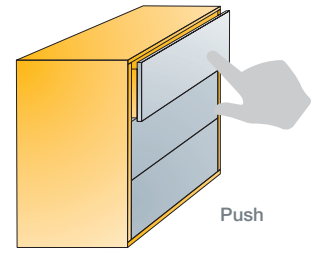

Push



Push latch



Push latch



Cross mounting plate



Linear mounting plate

	Spring force N (released)	Spring force N (loaded)	Item number	Bronze
Push latch	10	20	915-0X59 →	381
Push latch	13	27	915-0320 →	381
Linear m. plate			915-4175 →	381
Cross m. plate			915-4183 →	381

915-0X59-381-K1



200 Sets

915-0X59-381-K2

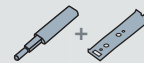

200 Sets

200 Pcs Made of steel and plastic

Fixing screws for mounting plates

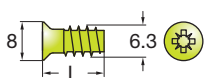

Euro screws
821-6323-050
10000 Pcs

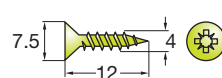

Chipboard screws

- Works with standard concealed hinges and drawers
- Effortless opening with just a light touch
- Depth adjustment ensures reliable closing and consistent performance in cases of inaccurate drilling
- 'Safety click' feature for easy detachment of the mechanism from the mounting plate

Drilling pattern

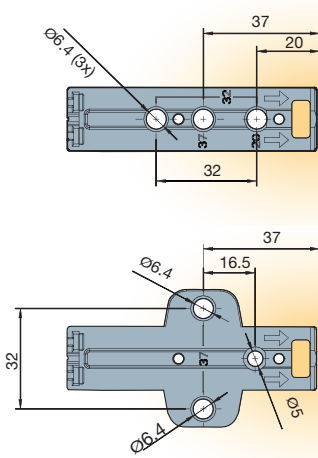

Dimensions

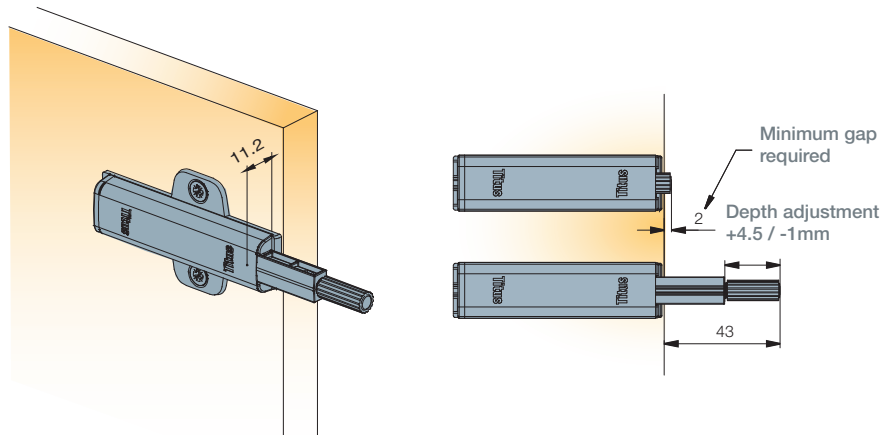

Positioning

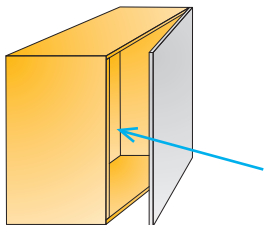

Close to the 'touch opening point' on the side opposite to hinges

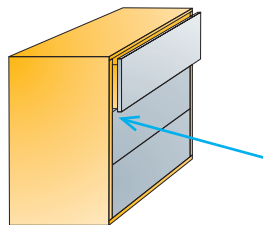

On the cabinet side; gap between drawer and cabinet side = min 12mm

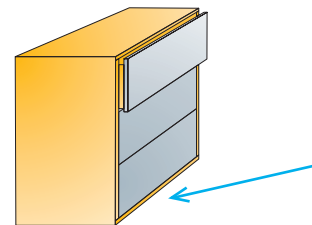

On the drawer bottom; in the middle of drawer

Push latch works with standard hinges.





Push latch works on drawer; the gap between the drawer and the cabinet side = min. 12 mm

Cover Caps

For hinge arms

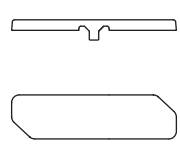
Titus recommends!

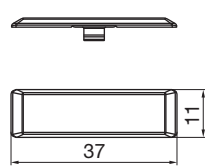
To improve appearance Titus recommends the use of hinge arm cover plates with all compatible concealed hinges.

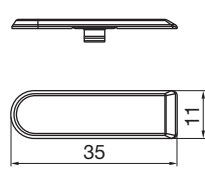
Technical details		Plate type	Material/surface	Item number	Nickel plated
S-type B-type  4000 Pcs Made of steel		Titus	steel	248-1646 →	050
		neutral	steel	248-1712 →	050
T-type  4000 Pcs Made of steel		Titus	steel	728-1286 →	054
		neutral	steel	728-1283 →	054
For T-type 110 0mm, 110/45 17mm, 110/90 17mm					
T-type  4000 Pcs Made of steel		Titus	steel	728-1287 →	054
		neutral	steel	728-1284 →	054
For T-type 110 5mm, 9mm, 17mm					

Other Functional Fittings

Drawer Solutions

17mm Drawer Slide

- Runners are paired in one piece moulding
- The guide rail steers the drawer and reduces jamming risk
- Integral drawer stop and hole plugs
- Manufactured in HDPE to provide a smooth glide action

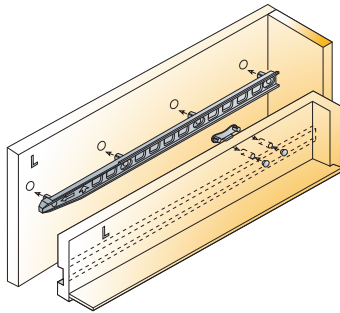

Technical and mounting details

17mm slide pair



Slide

Stop

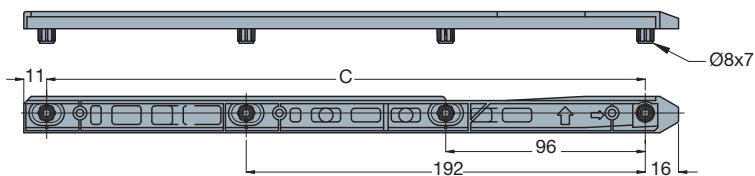
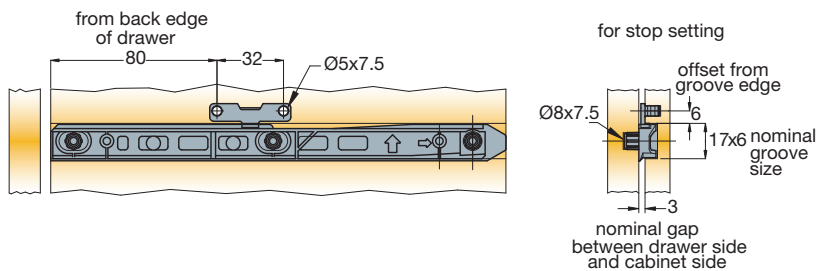

C	C-length	Item number	Color	
			Neutral	Powder grey
192		05179 →	846	886
260		05364 →		886
288		05184 →	846	
288		*05201 →	846	

**American market only*

One set consists of:

- 2 pcs slides
- 2 pcs stops





100 Sets

Made of plastic

Drawer Solutions

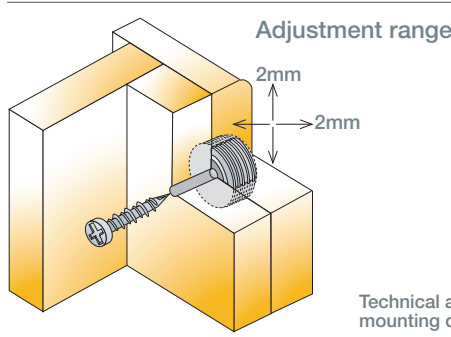

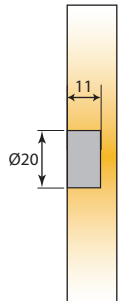
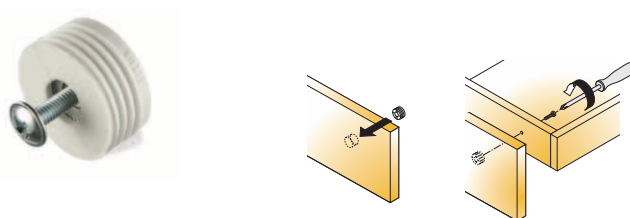
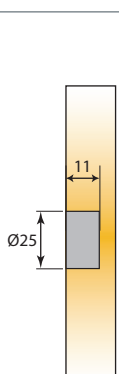

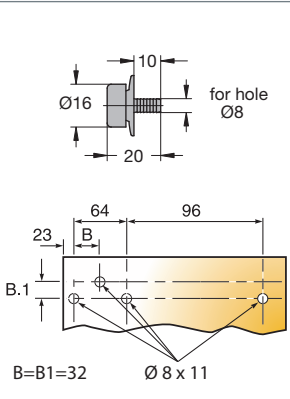
Drawer Front Adjuster (DFA)

- Multi-direction adjustment
- Locking screw to fasten
- Independent of drawer system
- One piece housing

 <p>Adjustment range 2mm 2mm</p> <p>Technical and mounting details</p> <p>Before After</p>					
DFA housing	Item number	Dark brown	Black	Nickel	White
 <p>2500 Pcs</p> <p>Made of plastic</p> 	06308 →	831			877
<p>DFA housing</p>  <p>2500 Pcs</p> <p>Made of zinc, plastic</p> 	*06310 →	831			877
	*06309 →	831			877
	*00033 →		847		
	*American market only				
	*06309 does not include screw				
<p>Runner wheel</p>  <p>4000 Pcs</p> <p>Made of plastic</p> 	00900 →	831	835		877

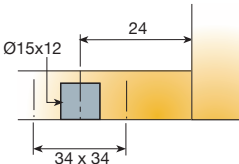
Adjustable Cabinet Leg Range

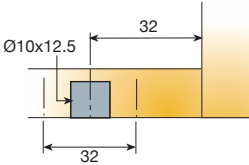
Leg Top Fixes

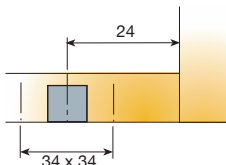
Technical and mounting details		Item number	Black
Rivet fix	 	regular	02560 → 835
		heavy duty	*02630 → 835
		<i>* American market only</i>	
Socket fix (knock in)	 	02558 →	835
Socket fix (screw on)	 	02559 →	835

 200 Pcs

Made of plastic

 200 Pcs





Made of plastic

 200 Pcs

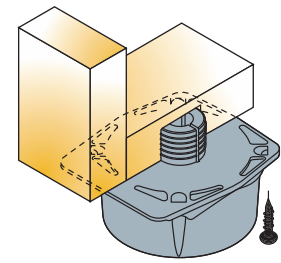
Made of plastic

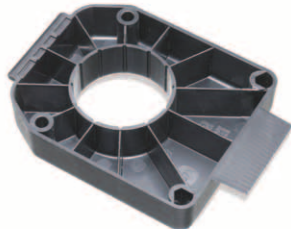
- Lip provides additional support to end panel and gives extra strength
- The side fix has twin dowel mounting for positive location
- Rivet fix design gives quick fastening of socket
- Choice of dowel or screw on sockets
- Invert second clip for corner plinth fixing

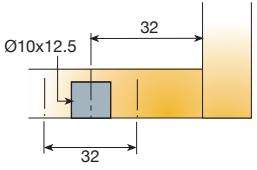

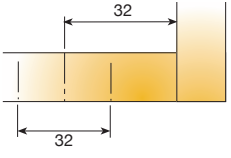





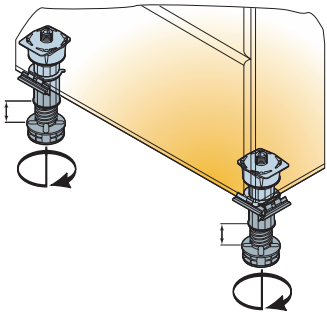

Technical and mounting details		A	D	B1	Item number	Black
		Drilling diameter	Drilling depth	Drilling distance		
Leg top  100 Pcs Made of plastic	(4 screws) screw on	3	6	64 x 64	02575 →	835
	(4 dowels + lip) dowel/lip	10	12.5	64 x 64	02582 →	835
	(4 screws + lip) screw/lip	3	6	64 x 64	02579 →	835
	2 dowels/2 screws	10/3	12.5/6	64 x 64	*02669 →	835
	screw on	3	6	64 x 64	*02671 →	835
	dowels	10	12.5	64 x 64	*02672 →	835
* Asian market only When using leg top, you must use foot with 01373 clip → see page 4.6						
Rivet fix/skid  200 Pcs Made of plastic					02663 →	835
						
Rivet fix/ no rivet  200 Pcs Made of plastic					*02642 →	835
	* Asian market only 					

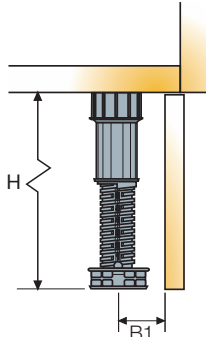
Adjustable Cabinet Leg Range

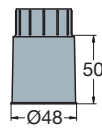
Adjustable Leg, Extension and Foot

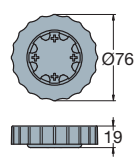
- Legs are supplied assembled at a pre-set height
- Wide adjustment range to fit all common plinth heights
- Jacking point adjustment feature
- Simple push on design to sockets

 Technical and mounting details		B1	H	Item number	Black
		Drilling distance	Fitting height adjustment		
Adjustable leg  		24	60-90	02570 →	835
		24	92-152	02549 →	835
		24	92.5-150	*02666 →	835
		24	92-150	*02648 →	835
		24	125-185	*02653 →	835
	big foot	38	92-150	*02699 →	835
	big foot	38	125-185	*02706 →	835
	<i>* Asian market only</i>				
 100 Pcs (02570) 200 Pcs	Made of plastic				
Leg extension	 			02571 →	835
 200 Pcs	Made of plastic				
Fixed foot	 			02569 →	835
				*02574 →	835
 200 Pcs	Made of plastic	<i>* American market only</i>			

Adjustable Cabinet Leg Range

Plinth Clips and Fox Clip

- Spring design eliminates the need for drilling and fits into any position on plinth
- The screw in version can sit in variable plinth positions
- When taking plinth around the corner, the fitting is reversible.

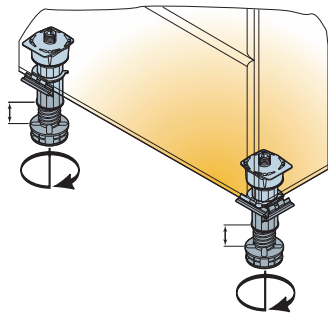

Technical and mounting details

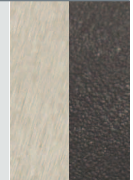

Fox clip

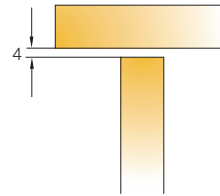

1000 Pcs

Made of plastic

Item number

01373 →

Natural

846

Black

Plinth clip 38 screw

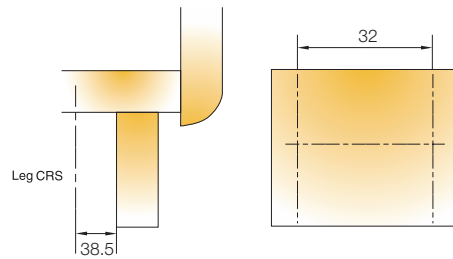

500 Pcs

Made of plastic

02578 →

835

*02710 →

835

* Asian market only

Plinth clip 24 knock on

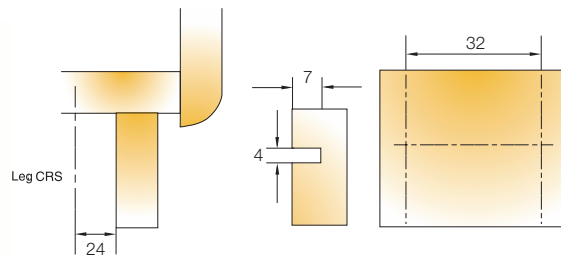

600 Pcs

Made of plastic

02523 →

835

Plinth clip 24 screw on

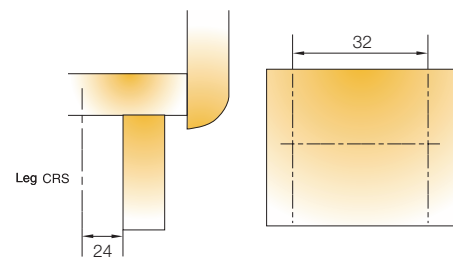

600 Pcs







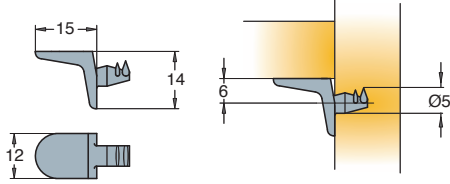
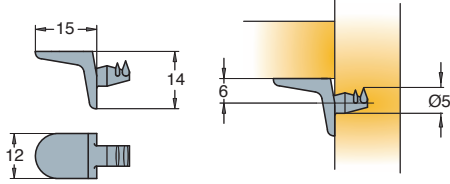

Made of plastic

02634 →

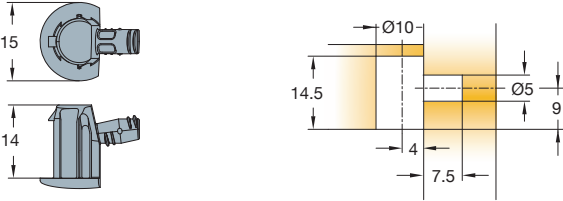
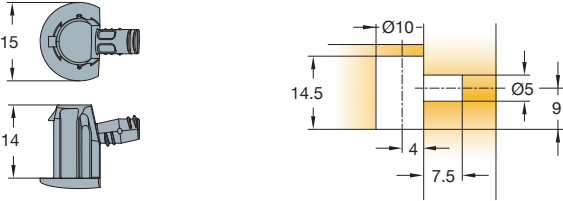
835

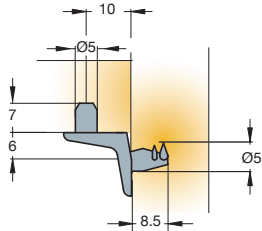
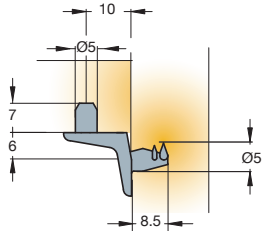
Shelf Supports

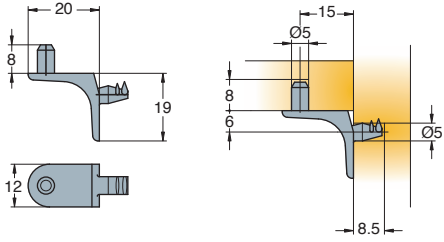
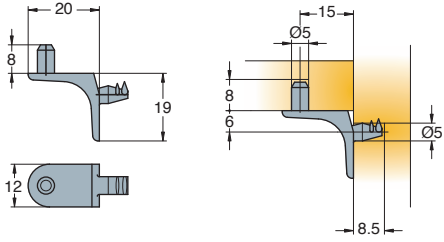
- Shelf supports are made of zinc, steel or plastic
- Teeth on mounting pin prevent rotation and fall-out of the fitting
- Screw-on and glass shelf versions are available

		Technical and mounting details		Item number	Nickel plated	Zinc
Without pin (rock-in)				336-3553 →	650	
 1000 Pcs	Made of zinc					
Structural shelf support				*01851 →	847	885
 3000 Pcs	Made of zinc			* American market only		
2 pins (rock-in)				336-3552 →	650	
 1000 Pcs	Made of zinc					
Pin Ø5x8 (rock-in)				336-3174 →	650	
 1000 Pcs	Made of zinc					

Shelf Supports

- Hold down feature traps the shelf in place for security
- Folding design allows the shelf to be post mounted in an assembled cabinet
- To suit a wide range of shelf thicknesses
- Pad for metal shelf support when using glass

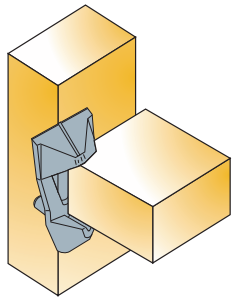

Technical and mounting details

Shelf support (push-in)

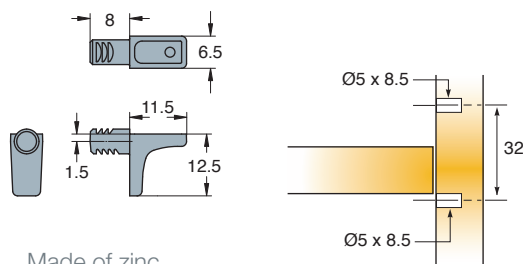

2000 Pcs

Made of zinc

Shelf support (push-in)

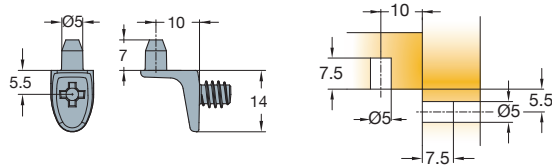

2000 Pcs

Made of zinc

Shelf holddown (for use with 01825)

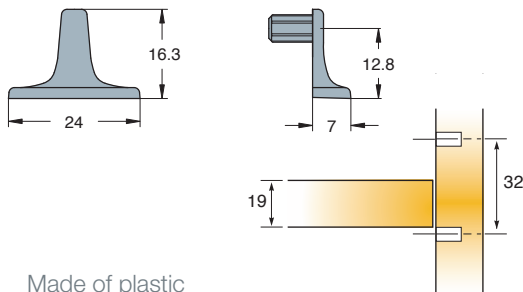

12000 Pcs

Made of plastic

Shelf support retainer

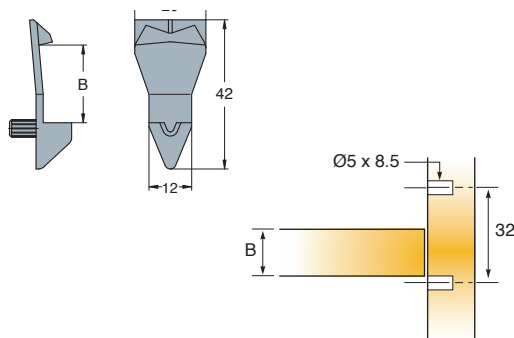

4000 Pcs
5000 Pcs (01837)

Made of plastic

B	Item number	Clear	Nickel	Zinc	White	Silver
	01825 →		847	885		
	01852 →		847			
	01822 →					861
15	01837 →				877	
16	01838 →	830				
16	*01828 →				877	
18	01823 →	830			877	861
19	01829 →				877	
19	01843 →	830				

* American market only
Other colours on request





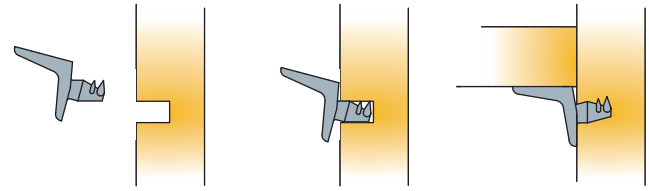

Shelf Supports

Mounting procedure:

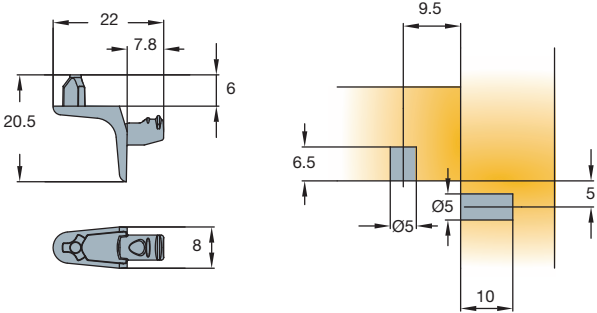

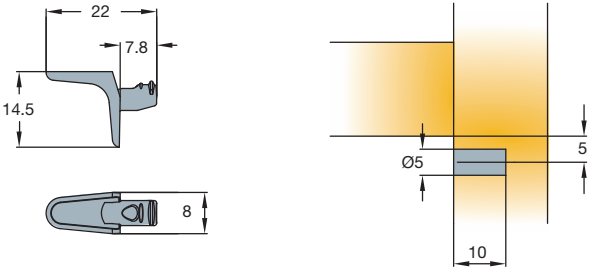
Technical and mounting details		Item number	Zinc plated blue	Nickel plated
<p>Pin Ø5x10 (screw-on)</p>  	<p>1000 Pcs</p> <p>Made of zinc</p>	338-3687 →		650
<p>For glass shelves (rock-in)</p>  	<p>1000 Pcs</p> <p>Made of zinc and plastic</p>	338-9721 →		860
<p>Pin Ø5x10 (rock-in)</p>  	<p>1000 Pcs</p> <p>Made of zinc</p>	338-3686 →		650

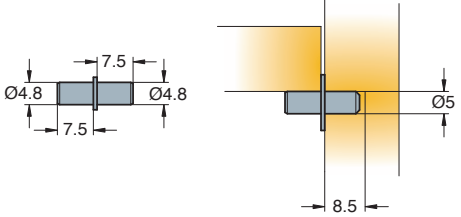
Shelf Supports

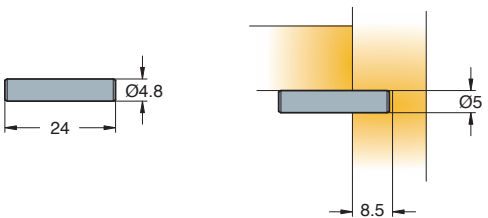
		Technical and mounting details		Item number	Zinc plated blue	Nickel plated	Antique brass plated
<p>Shelf support with pin</p>  <p>2000 Pcs</p>		01910 →		847			
<p>Shelf support</p>  <p>2000 Pcs</p>		01911 →		847			
<p>Pin</p>  <p>5000 Pcs Made of steel</p>		334-6073 →	040	050			
<p>Pin</p>  <p>5000 Pcs Made of steel</p>		335-6076 →	040		080		

No-Tools Backfix and Trimfix™

- Push Backfix into panel
- No tools required to lock the Backfix panels together
- The handle on Backfix acts as a stop during locking, providing greater accuracy and speed of insertion
- Barbs on the Backfix provide a quality fastener for rigid cabinet construction

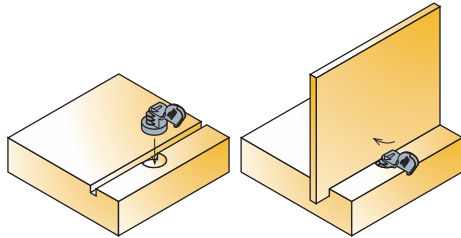

Technical and mounting details



Item number	Zinc	Corrosil	Phosphate	Zinc plated
-------------	------	----------	-----------	-------------

Hardboard Backfix

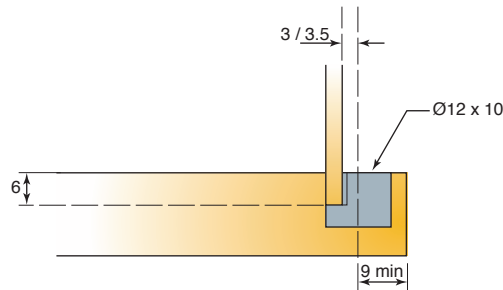

02154 →	885	897		
---------	-----	-----	--	--

1000 Pcs

Made of zinc

Trimfix™

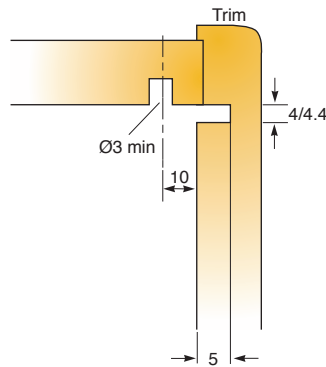

01370 →			852	
---------	--	--	-----	--

2000 Pcs

Made of various material

Screw panhead No 8 x 17.6









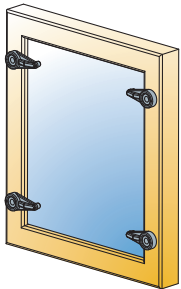

01709 →				883
---------	--	--	--	-----

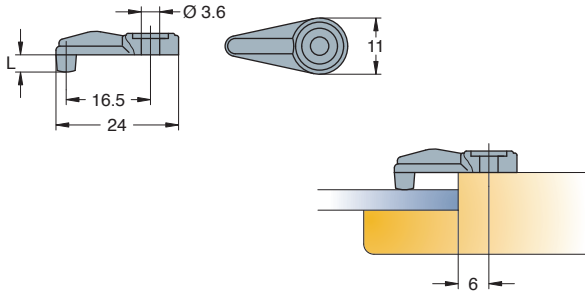
15000 Pcs

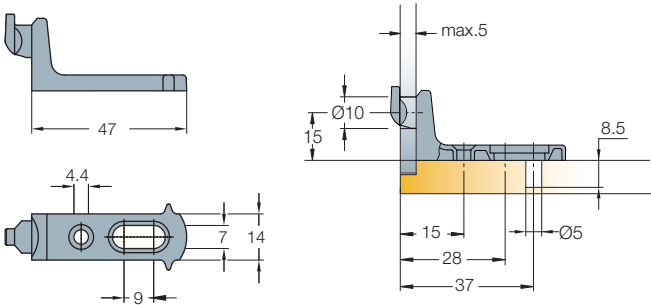
Made of zinc

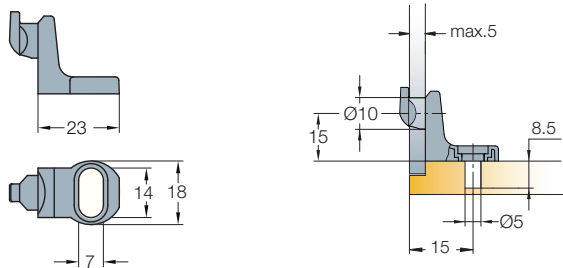
Glass Clip Rear Wall Connectors

 <p>Drawing shows glass clips mounting example.</p>		L		
Glass clip	Technical and mounting details	Pin length	Item number	Nickel plated / Transparent
		3.3	359-4201 →	340
		6	359-4302 →	340
		9.5	359-4223 →	340
 25000 Pcs	Made of plastic			
Rear wall connector long 			353-3649 →	650
		 500 Pcs	Made of zinc	
Rear wall connector short 			353-3650 →	650
		 500 Pcs	Made of zinc	

Panel Brackets

- To be used to fix face frames to carcasses without additional drilling to cabinet
- Designed for carcase side panel of 18mm thickness
- Edge to hole centre = 28mm
- Easier fixing of frames due to parts that remain in holes once inserted

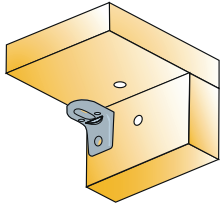

Technical and mounting details



Nickel plated

Zinc

Item number

90° Bracket (screw-in/rock-in peg)

02111 →

847

885

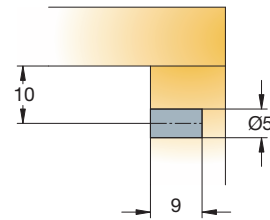
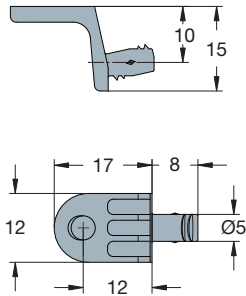

1000 Pcs

Made of zinc

90° Bracket (screw-in)

02110 →

847

885

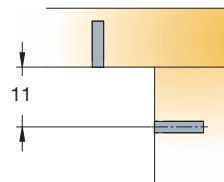
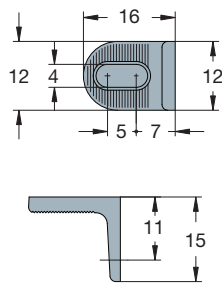

1000 Pcs

Made of zinc

Corner bracket (rock-in)

02133 →

885

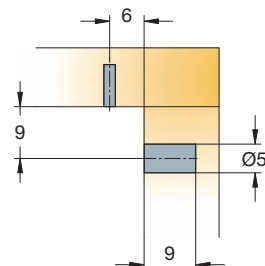
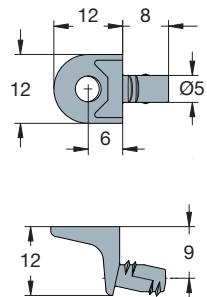

1000 Pcs

Made of zinc

Wardrobe Rail Rail Supports

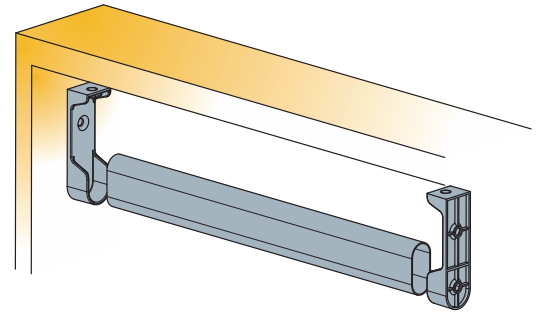



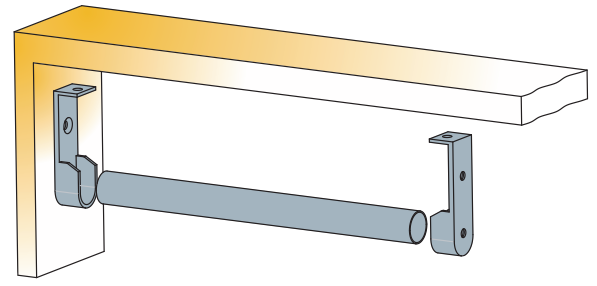

		Technical and mounting details	Item number	Chrome plated	Nickel plated
Rail			339-7047 →	060	
10 Pcs	Made of chrome plated steel		Standard length 3m Standard length is 3m. Other lengths available upon special request → see page 0.3		
Rail support 3-holes			337-3710 →		650
200 Pcs	Made of zinc				
Rail support 2-pins			337-3711 →		650
200 Pcs	Made of zinc				
Rail support M6			337-3709 →		650
200 Pcs	Made of zinc				

Wardrobe Rail

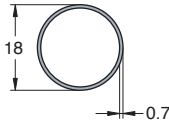
Ø18

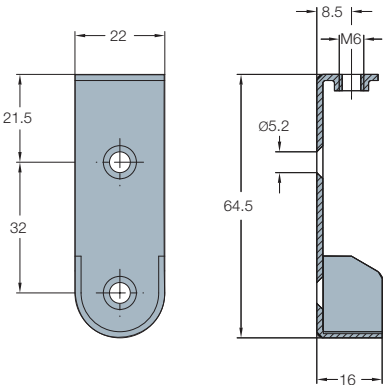

		Technical details	Item number	Chrome plated	Nickel plated
Rail	 	<p>Standard length is 3m. Other lengths available upon special request → see page 0.3</p>	339-7041 →	060	
 10 Pcs	Made of steel, chrome plated				
Screw-on under a shelf	 	<p>M6 screw supplied separately:</p> <p>815-6354-040</p>  1000 Pcs	337-1398 →		050
 300 Pcs	Made of steel				

The Titus Group Profile

Titus Group

Titus focuses on the design, manufacture and distribution of connectors, concealed hinges drawers and soft closing mechanisms in furniture and household appliances.

Titus Group is owned and managed from its headquarters in United Kingdom. We are able to provide products and services to every customer around the world based on manufacturing facilities in Europe, North America, China, SE Asia, Australia and New Zealand.

Quickfit technology makes Titus the World leader in connectors for RTA furniture

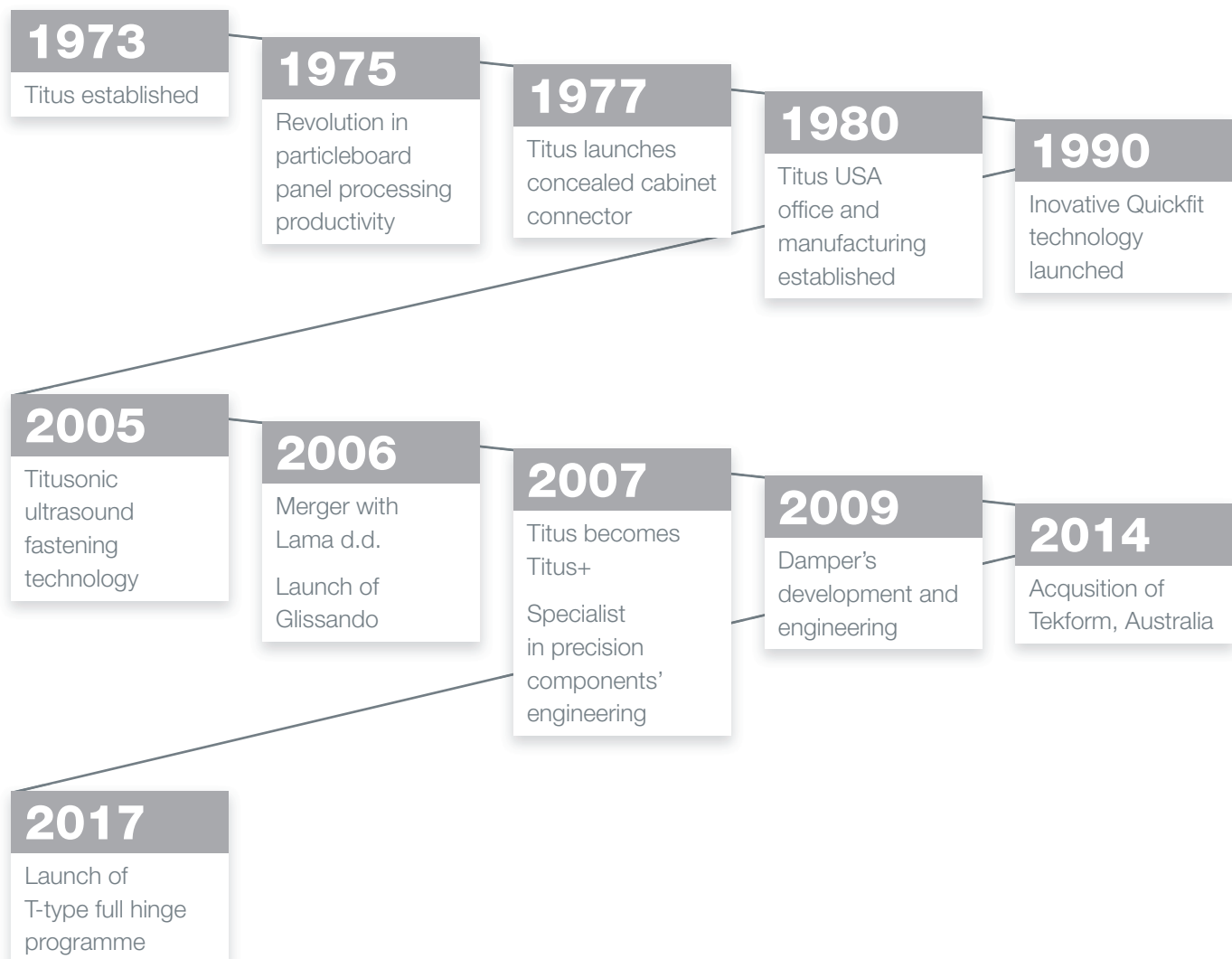

Vision

The world's best engineering for precision components

Mission

To provide manufacturers with components' solutions that improve competitiveness

Titus Business Philosophies and Principles

- Gain total knowledge of our customers and their markets
- Focus on identifying and creating high volume component niches
- Meet our customers' expectations with global consistency
- Build long term associations with customers, suppliers, colleagues and shareholders
- Invest in the abilities of individuals at every level
- Continuously enhance input efficiency and sustainability

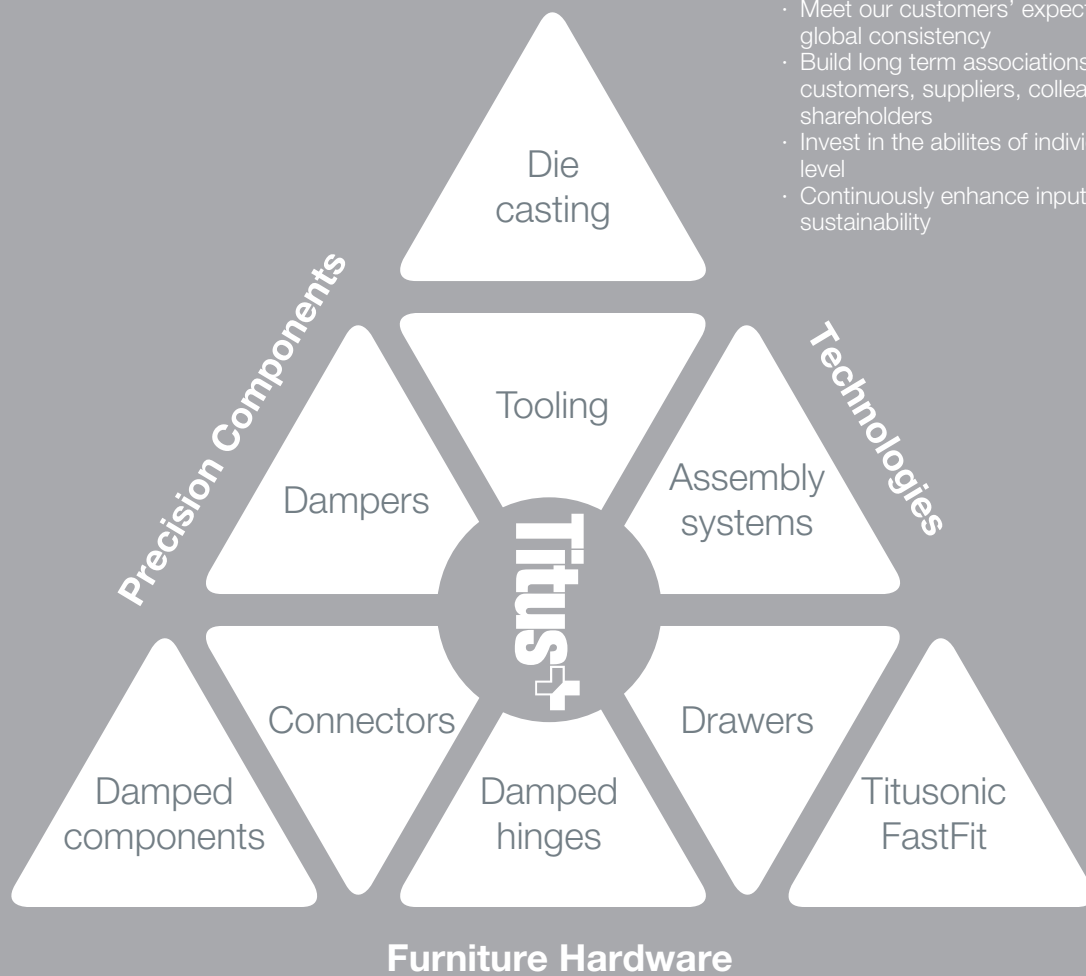

Furniture Hardware

- Cabinet connectors
- Concealed hinges
- Soft closing systems
- Drawers and drawer systems
- Kitchen accessories
- Furniture locks
- Decorative

Components

- Dampers
- Precision components

Technologies

- Automation systems
- Precision castings
- Die cast technologies
- Tooling
- Ultrasound fastening technology
- FastFit technology

'Totally Integrated Engineering'

Product Design

Design and engineering of unique components
Consistent and repeatable product quality

Manufacturing Technologies

to improve productivity and product quality

Manufacturing Operations

A wide array of technologies and services required for high volume production of precision components available in-house

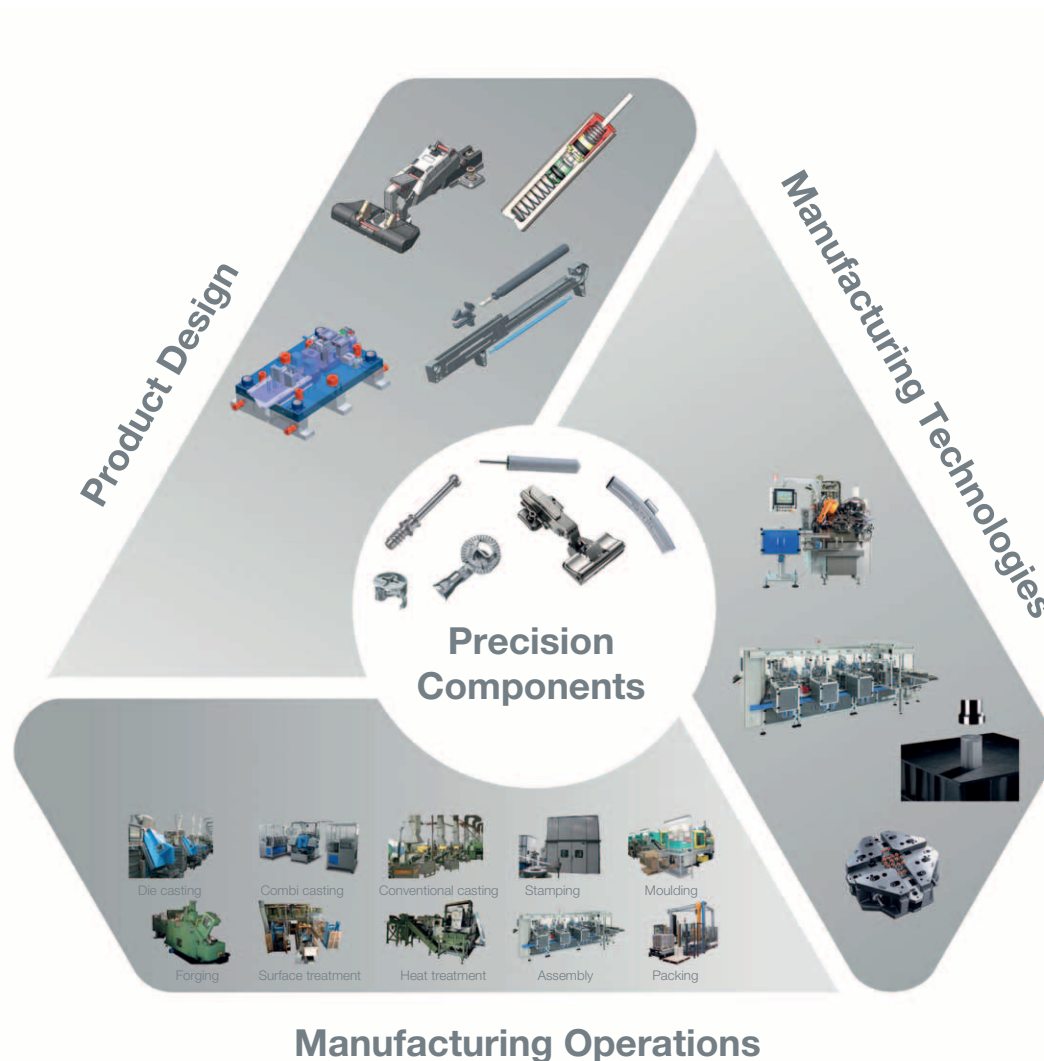

Fittings for purpose

Unique product advantages for better value for money and lower 'total installed cost'

Innovations that improve

with less parts, less different parts, less preparation actions, faster assembly

Fast time-to-market

Quality

Continuous Improvement

The Titus Group Mission, to improve the competitiveness of our customers, encourages us to continuously improve our products, services, processes and competencies of our employees.

Quality

We believe that the Titus Mission is achieved most effectively through the management of our design, manufacturing and service activities in conformance with the ISO 9001 standard for quality management. Quality has a broad meaning for us: it is our guide to the selection of materials, work, processes, internal relations and cooperation with partners.

Products

Our integrated quality system produces technically optimized products of high quality. They are assessed regularly in our own test labs as well as by internationally renowned institutions, such as LGA from Germany, CTBA from France, FIRA from United Kingdom, CATAS from Italy, AIDIMA from Spain, and others.

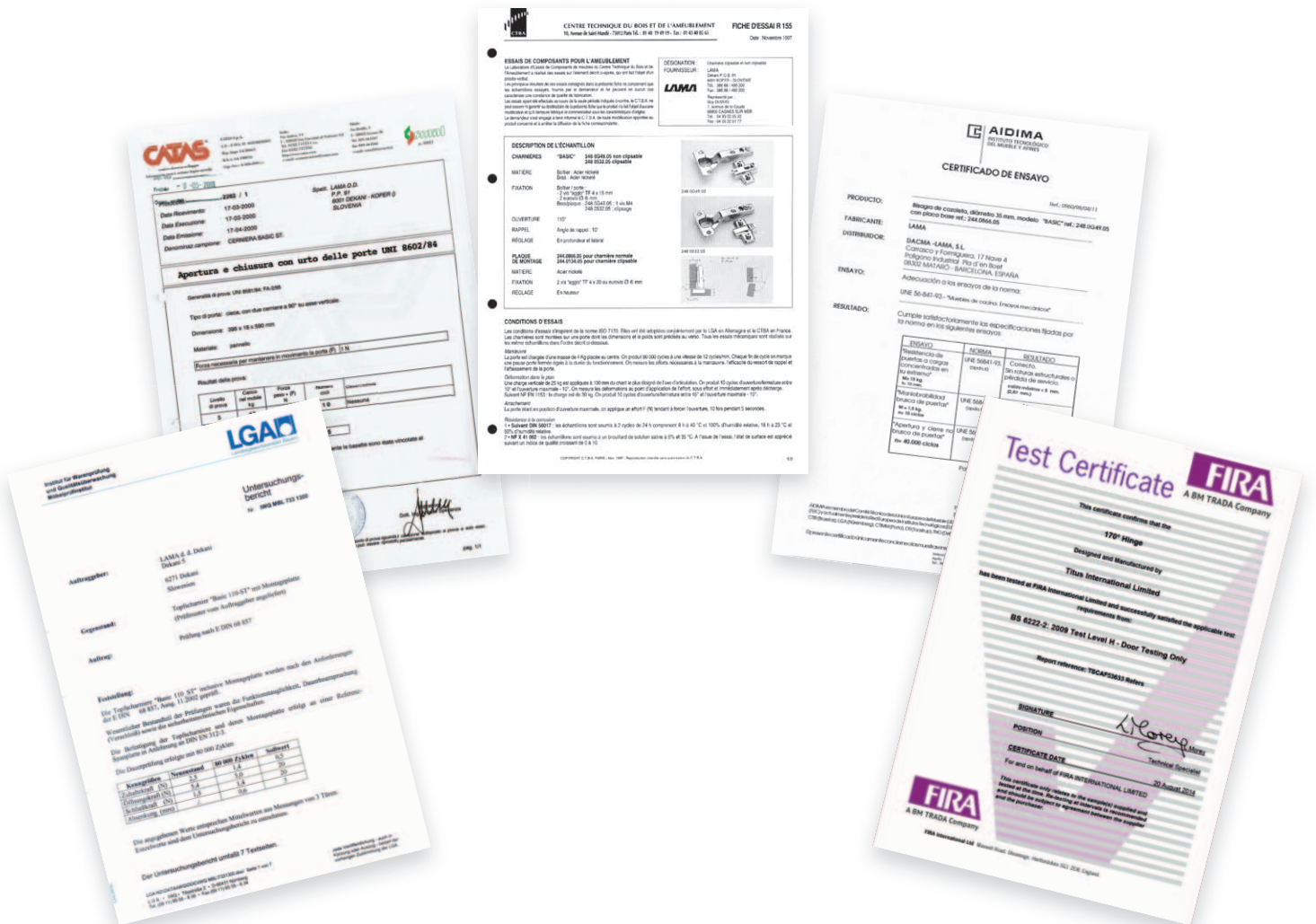

Global player

Worldwide design, manufacturing and distribution capabilities

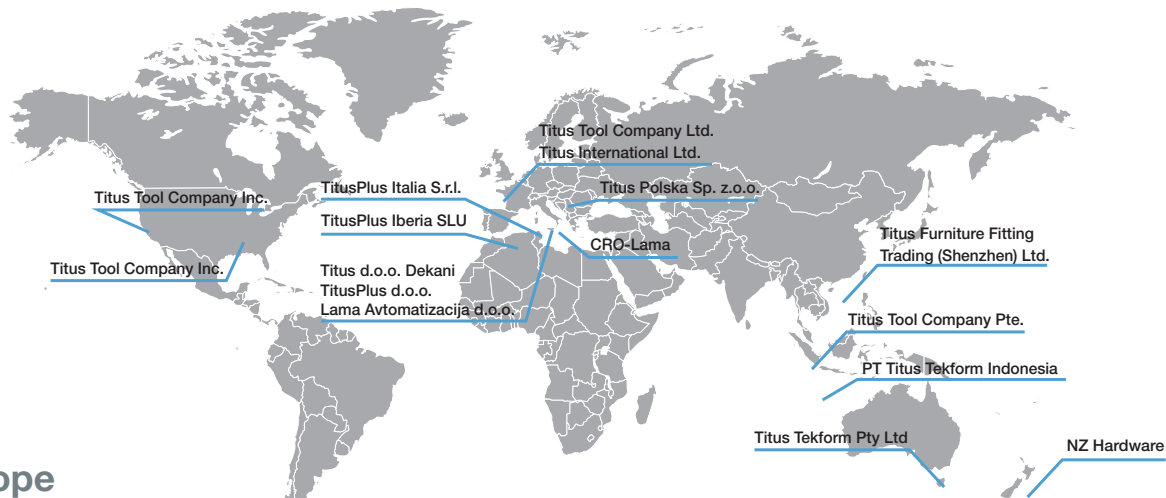

Europe

TitusPlus d.o.o.
 Dekani 5
 SI-6271 Dekani
 Slovenia
 +386 566 90 213
 +386 566 90 205 Fax
 info@titusplus.com

Titus d.o.o. Dekani
 Dekani 5
 SI-6271 Dekani
 Slovenia
 +386 566 90 213
 +386 566 90 205 Fax
 info@titusplus.com

Titus Technologies
Lama Avtomatizacija d.o.o.
 Dekani 5
 SI-6271 Dekani
 Slovenia
 +386 566 90 432
 +386 566 90 431 Fax
 titustechnologies@titusplus.com

Titus Tool Company Ltd.
 10 Blackburn Industrial Estate
 Enterprise Way
 Sherburn in Elmet
 LS256NA
 United Kingdom
 +44 1977682 582
 +44 1977680 481 Fax
 uk@titusplus.com

CRO-Lama
 Rakitska 10a
 Rakitje
 HR-10437 Bestovje
 Croatia
 +385 1 3323 033
 +385 1 3323 233 Fax
 croatia@titusplus.com

Titus Polska Sp. z .o.
 ul. Stefańskiego 17 A
 PL-62-002 Suchy Las/Poznań
 Poland
 +4861 811 5402 Phone/Fax
 +4861 811 5684 Phone/Fax
 +4861 821 9362
 poland@titusplus.com

TitusPlus Italia Srl
 Via Aquileia 9
 Frazione Olmi
 31048 San Biagio di Callalta (TV)
 +39 04 221 650 120
 +39 04 221 650 136 Fax
 italia@titusplus.com

TitusPlus Iberia SLU
 C/ Gran Bretanya 34
 08520 Les Franqueses del Valles
 (Barcelona)
 +34 938 715 404
 +34 938 605 498 Fax
 iberia@titusplus.com
 www.titusplusiberia.com

America

Titus Tool Co. Inc.
 2800 156th Avenue SE
 Suite 135
 Bellevue, WA 98007, USA
 800 762 1616 toll free
 +1 253 872 2829
 +1 253 872 2827 Fax
 usa@titusplus.com

Titus Tool Co. Inc.
 220 Messner Drive
 US-60090 Wheeling, USA
 800 762 1616 toll free
 +1 253 872 2829
 +1 253 872 2827 Fax
 usa@titusplus.com

Avstralia

Titus Tekform Pty Ltd
 Unit 1, 41-43 Whyalla Place
 Prestons NSW 2170
 Australia
 +61 2 9286 0007
 +61 2 9826 0074 Fax
 www.titustekform.com.au
 info@titustekform.com.au

NZ Hardware Enterprises Ltd
 34 Waipareira Avenue
 Henderson
 Auckland, New Zealand
 +64 9 837 0886
 +64 9 837 8003Fax

Asia

Titus Tool Co. Pte. Ltd.
 5004 Ang Mo Kio Ave 5
 Techplace II #04-01
 Singapore 569872
 +656383 3922
 +656383 3178 Fax
 singapore@titusplus.com

Titus SZ Components limited
 1st Floor, Building No.2,
 Hengchangrong Hi-tech Industrial Park
 128 Shangnan East Road
 Hongtian, Shajing, Baoan District
 Shenzhen, Guangdong Province
 PRC 518125
 china@titusplus.com

Titus Tekform Indonesia, PT
 Taman Tekno Blok L2 / 7
 BSD Sektor XI - Tangerang 15314
 Indonesia
 T. +62 21 75873578
 F. +62 21 75873574
 Indonesia@titusplus.com

Headquarters

Titus International Ltd
 325 Euston Road
 London
 NW1 3AD, United Kingdom
 info@titusplus.com

www.titusplus.com
 info@titusplus.com

Index

Item number	Page
00021	1.19
00022	1.19
00033	4.4
00062	1.9
00068	1.9
00071	1.9
00072	1.9
00171	1.9
00177	1.9
00180	1.8
00900	4.4
01020	1.9
01029	1.63
01042	1.9
01056	1.9
01370	4.13
01373	4.8
01709	1.12
01709	4.13
01732	1.12
01822	4.10
01823	4.10
01825	4.10
01828	4.10
01829	4.10
01837	4.10
01838	4.10
01843	4.10
01851	4.9
01852	4.10
01910	4.12
01911	4.12
02046	1.12
02075	1.13
02077	1.13
02107	1.20
02110	4.15
02111	4.15
02120	1.20
02130	1.20
02133	4.15
02139	1.20
02141	1.20
02144	1.20
02154	4.13
02161	1.19
02182	1.62
02190	1.19
02193	1.19
02523	4.8
02549	4.7
02558	4.5
02559	4.5

Item number	Page
02560	4.5
02569	4.7
02570	4.7
02571	4.7
02574	4.7
02575	4.6
02578	4.8
02579	4.6
02582	4.6
02630	4.5
02634	4.8
02648	4.7
02653	4.7
02663	4.6
02663	4.6
02666	4.7
02669	4.6
02671	4.6
02672	4.6
02699	4.7
02706	4.7
02710	4.8
02985	1.12
03090	1.16
03118	1.16
03121	1.16
03150	1.16
03168	1.16
03180	1.16
03181	1.16
05129	1.33
05137	1.33
05179	4.3
05184	4.3
05201	4.3
05314	1.32
05364	4.3
05380	1.37
05388	1.32
05409	1.57
05410	1.57
05414	1.34
05441	1.32
05453	1.32
05474	1.32
05503	1.32
05552	1.33
05554	1.33
05556	1.33
05563	1.33
05570	1.33
05574	1.44
05575	1.44

Item number	Page
05576	1.44
05578	1.44
05579	1.44
05580	1.44
05586	1.43
05587	1.43
05592	1.37
05608	1.39
05609	1.39
05610	1.39
05611	1.39
05644	1.43
05652	1.43
05653	1.43
05654	1.43
05656	1.43
05657	1.43
05658	1.43
05659	1.43
05675	1.43
05676	1.43
05677	1.43
05678	1.43
05679	1.43
05685	1.33
05714	1.33
05751	1.37
05752	1.37
05753	1.37
05757	1.37
05772	1.37
05774	1.37
05775	1.37
05778	1.37
05786	1.39
05787	1.39
05857	1.37
05858	1.37
05859	1.37
05860	1.38
05917	1.60
05929	1.37
05960	1.60
05971	1.60
06073	1.13
06074	1.9
06077	1.9
06080	1.9
06308	4.4
06309	4.4
06310	4.4
06381	1.54
06383	1.54

Item number	Page
06385	1.54
06387	1.54
06395	1.52
06397	1.52
06401	1.48
06402	1.48
06403	1.48
06405	1.48
06406	1.48
06408	1.47
06410	1.47
06411	1.50
06412	1.50
06413	1.49
06414	1.49
06415	1.50
06416	1.49
06431	1.51
06433	1.51
06435	1.51
06437	1.51
06439	1.52
06441	1.52
06443	1.52
06445	1.52
06447	1.51
06449	1.51
06451	1.51
06453	1.51
06455	1.52
06457	1.52
06459	1.52
06461	1.52
06464	1.53
06465	1.53
06470	1.53
06471	1.53
06472	1.53
06473	1.53
06479	1.47
06495	1.48
06803	1.18
06806	1.18
06813	1.18
06839	1.18
06947	1.56
06949	1.55
06951	1.56
06953	1.55
09406	1.42
09423	1.35
09424	1.35
09430	1.36

Index

Item number	Page
09435	1.35
09443	1.35
09456	1.35
09491	1.42
09495	1.41
09533	1.41
09536	1.41
09537	1.41
09583	1.35
09588	1.35
09592	1.35
09594	1.35
09597	1.36
09631	1.42
09651	1.31
09652	1.31
09690	1.40
09692	1.40
09695	1.40
09699	1.40
244-0260-050	3.144
241-0043-650	3.145
241-0050-650	3.145
244-0036-650	3.138
244-0062-650	3.136
244-0063-650	3.136
244-0067-650	3.136
244-0068-650	3.136
244-0085-650	3.100
244-0095-650	3.100
244-0118-050	3.100
244-0119-050	3.100
244-0120-050	3.100
244-0134-050	3.100
244-0135-050	3.100
244-0136-050	3.100
244-0137-050	3.100
244-0166-050	3.100
244-0167-050	3.100
244-0175-650	3.136
244-0232-650	3.136
244-0258-050	3.98
244-0259-050	3.98
244-0260-050	3.98
244-0261-050	3.98
244-0262-050	3.98
244-0263-050	3.98
244-0264-050	3.98
244-0265-050	3.98
244-0266-050	3.98
244-0270-050	3.98
244-0271-050	3.98
244-0272-050	3.98

Item number	Page
244-0342-050	3.98
244-0343-050	3.98
244-0344-050	3.98
244-0561-050	3.100
244-0562-050	3.100
244-0565-050	3.100
244-0566-050	3.100
244-0567-050	3.100
244-0568-050	3.100
244-0655-050	3.147
244-0810-650	3.113
244-0810-650	3.113
244-0810-650	3.123
244-0813-650	3.123
244-0846-050	3.147
244-0848-650	3.145
244-0866-050	3.136
244-0867-050	3.136
244-0907-650	3.145
244-0914-650	3.136
244-0929-050	3.136
244-0930-050	3.136
244-0965-050	3.136
244-0B12-650	3.136
244-0C32-650	3.123
244-0D46-650	3.145
244-0D47-650	3.145
244-0D99-650	3.145
244-0E02-650	3.145
244-0G19-050	3.136
244-0H64-050	3.136
244-0H65-050	3.136
244-0K95-050	3.136
244-0K96-050	3.136
244-0K97-650	3.136
244-0K98-650	3.136
244-0L26-050	3.136
244-0L29-050	3.136
244-0L37-650	3.136
244-0L38-650	3.136
244-0L39-050	3.136
244-0L40-050	3.136
244-0L50-050	3.136
244-0L98-050	3.136
244-0M28-650	3.136
244-0M29-650	3.136
244-0M33-650	3.100
244-0P24-050	3.136
244-0P25-050	3.136
244-0P26-050	3.100
244-0P27-050	3.100
244-0P28-650	3.123
244-0P29-650	3.100

Item number	Page
244-0P41-650	3.136
244-0S65-050	3.136
244-0S66-050	3.136
244-0S67-050	3.136
244-0S68-050	3.136
244-0T14-650	3.136
244-0T28-050	3.136
244-0T40-050	3.136
244-0V19-050	3.100
244-0V50-050	3.138
244-0V64-050	3.136
244-0Z26-050	3.100
244-0Z51-050	3.100
244-0Z63-050	3.100
244-1136-050	3.100
244-1138-050	3.100
244-1139-050	3.100
244-1228-050	3.100
244-1229-050	3.100
244-1233-050	3.100
244-1234-050	3.100
244-1645-050	3.100
244-3016-650	3.100
244-3651-650	3.100
244-3653-650	3.102
244-3654-650	3.102
244-3655-650	3.102
244-7314-050	3.144
244-7315-050	3.144
244-7316-050	3.144
244-7318-050	3.144
244-7324-050	3.144
244-7325-050	3.144
244-7326-050	3.144
244-7328-050	3.144
248-0080-050	3.77
248-0160-050	3.129
248-0161-050	3.129
248-0162-050	3.93
248-0163-050	3.93
248-0171-050	3.73
248-0172-050	3.73
248-0186-050	3.73
248-0188-050	3.73
248-0197-050	3.73
248-0198-050	3.91
248-0255-050	3.123
248-0274-050	3.69
248-0279-050	3.73
248-0280-050	3.73
248-0283-050	3.85
248-0285-050	3.85
248-0291-050	3.85

Item number	Page
248-0308-050	3.95
248-0327-050	3.73
248-0328-050	3.73
248-0366-050	3.73
248-0377-050	3.69
248-0400-050	3.73
248-0401-050	3.73
248-0402-050	3.73
248-0431-050	3.83
248-0433-050	3.83
248-0482-050	3.73
248-0487-050	3.73
248-0518-050	3.83
248-0532-050	3.73
248-0533-050	3.73
248-0534-050	3.73
248-0535-050	3.73
248-0536-050	3.73
248-0537-050	3.73
248-0538-050	3.73
248-0539-050	3.73
248-0540-050	3.73
248-0545-050	3.73
248-0547-050	3.73
248-0549-050	3.73
248-0551-050	3.73
248-0665-050	3.81
248-0675-050	3.81
248-0677-050	3.81
248-0742-050	3.87
248-0745-050	3.87
248-0748-050	3.87
248-0C66-050	3.77
248-0G49-050	3.115
248-0G50-050	3.115
248-0G51-050	3.115
248-0G52-050	3.117
248-0G53-050	3.123
248-0G54-050	3.115
248-0G55-050	3.115
248-0G56-050	3.115
248-0G57-050	3.117
248-0G58-050	3.123
248-0G59-050	3.115
248-0G60-050	3.115
248-0G61-050	3.115
248-0G62-050	3.117
248-0G63-050	3.123
248-0G79-050	3.115
248-0G80-050	3.115
248-0G81-050	3.115
248-0G82-050	3.117
248-0G83-050	3.123

Index

Item number	Page
248-0K10-050	3.147
248-0K40-050	3.115
248-0K76-050	3.115
248-0L04-050	3.115
248-0L27-650	3.119
248-0L28-050	3.121
248-0L32-650	3.119
248-0L33-050	3.121
248-0L46-050	3.121
248-0L51-050	3.127
248-0L61-050	3.87
248-0L63-050	3.115
248-0L70-050	3.121
248-0L71-050	3.119
248-0L72-050	3.117
248-0L73-050	3.123
248-0M41-050	3.147
248-0M73-050	3.91
248-0M74-050	3.91
248-0M83-050	3.119
248-0M84-050	3.121
248-0N12-050	3.81
248-0N13-050	3.81
248-0N14-050	3.81
248-0N16-050	3.83
248-0N17-050	3.83
248-0N18-050	3.83
248-0N20-050	3.85
248-0N21-050	3.85
248-0N22-050	3.85
248-0N24-050	3.87
248-0N25-050	3.87
248-0N26-050	3.87
248-0N38-050	3.119
248-0N62-050	3.87
248-0P43-050	3.127
248-0R09-050	3.147
248-0R10-050	3.127
248-0R11-050	3.127
248-0R12-050	3.127
248-0R13-050	3.91
248-0R14-050	3.91
248-0R15-050	3.91
248-0R17-050	3.91
248-0R18-050	3.91
248-0S05-050	3.127
248-0S06-050	3.127
248-0S69-050	3.91
248-0T10-050	3.69

Item number	Page
248-0T13-050	3.69
248-0T69-050	3.69
248-0T70-050	3.69
248-0T71-050	3.69
248-0T72-050	3.69
248-0T80-050	3.131
248-0T81-050	3.131
248-0T93-050	3.69
248-0T94-050	3.69
248-0T95-050	3.69
248-0U13-050	3.131
248-0U14-050	3.131
248-0U16-050	3.95
248-0U21-050	3.95
248-0U22-050	3.95
248-0V14-050	3.75
248-0V15-050	3.95
248-0V18-050	3.79
248-0V39-050	3.75
248-0V40-050	3.75
248-0V41-050	3.75
248-0V42-050	3.75
248-0V43-050	3.75
248-0V45-050	3.79
248-0V47-050	3.79
248-0V48-050	3.79
248-0V49-050	3.79
248-0V53-050	3.123
248-0V56-050	3.69
248-0V62-050	3.77
248-0V65-050	3.91
248-0V66-050	3.123
248-0V69-050	3.69
248-0V70-050	3.69
248-0V71-050	3.69
248-0V72-050	3.69
248-0Z20-050	3.95
248-0Z29-050	3.79
248-0Z81-050	3.87
248-1646	3.151
248-1712	3.151
248-3600-650	3.102
248-3603-650	3.102
249-7301-050	3.139
249-7302-050	3.139
249-7303-050	3.141
249-7304-650	3.141
275-0103	1.59
275-0106	1.59

Item number	Page
275-2030	1.58
275-2057	1.59
275-2058	1.59
275-2146	1.59
275-2209	1.58
275-3096	1.58
275-4034	1.63
275-4035	1.62
275-4058	1.62
276-4036	1.62
277-4225	1.63
277-4355	1.63
278-4129	1.21
279-9187	1.22
279-9465	1.22
334-6073	4.12
335-6076	4.12
336-3174	4.9
336-3552	4.9
336-3553	4.9
337-1398	4.17
337-3709	4.16
337-3710	4.16
337-3711	4.16
338-3686	4.11
338-3687	4.11
338-9721	4.11
339-7041	4.17
339-7047	4.16
353-3649	4.14
353-3650	4.14
359-4201	4.14
359-4223	4.14
359-4302	4.14
408-3166	1.61
408-3391	1.61
408-3423	1.61
408-3424	1.61
44-1137-050	3.100
700-0KE4-054	3.52
700-0KA0-054	3.52
700-0KA1-054	3.52
700-0KA2-054	3.52
700-0KA3-054	3.52
700-0KA4-054	3.52
700-0KB0-054	3.52
700-0KB1-054	3.52
700-0KB2-054	3.52
700-0KB3-054	3.52

Item number	Page
700-0KB4-054	3.52
700-0KC0-054	3.52
700-0KC1-054	3.52
700-0KC2-054	3.52
700-0KC3-054	3.52
700-0KC4-054	3.52
700-0KE0-054	3.52
700-0KE1-054	3.52
700-0KE2-054	3.52
700-0KE3-054	3.52
700-0KF0-054	3.52
700-0KF1-054	3.52
700-0KF2-054	3.52
700-0KF3-054	3.52
700-0KF4-054	3.52
700-0LB0-650	3.52
700-0LB2-650	3.52
700-0LB3-650	3.52
700-0LC0-650	3.52
700-0LC2-650	3.52
700-0LC3-650	3.52
700-0LF0-650	3.52
700-0LF2-650	3.52
700-0LF3-650	3.52
700-0NA0-054	3.54
700-0NA1-054	3.54
700-0NA2-054	3.54
700-0NA3-054	3.54
700-0NA4-054	3.54
700-0NB0-054	3.54
700-0NB1-054	3.54
700-0NB2-054	3.54
700-0NB3-054	3.54
700-0NB4-054	3.54
700-0NC0-054	3.54
700-0NC1-054	3.54
700-0NC2-054	3.54
700-0NC3-054	3.54
700-0NC4-054	3.54
700-0NE0-054	3.54
700-0NE1-054	3.54
700-0NE2-054	3.54
700-0NE3-054	3.54
700-0NE4-054	3.54
700-0NF0-054	3.54
700-0NF1-054	3.54
700-0NF2-054	3.54
700-0NF3-054	3.54
700-0NF4-054	3.54

Index

Item number	Page
700-ONR0-054	3.54
700-ONR1-054	3.54
700-ONR2-054	3.54
700-ONR3-054	3.54
700-ONR4-054	3.54
700-ONW0-054	3.54
700-ONW3-054	3.54
701-0A96-054	3.35
701-0A98-054	3.35
701-0AS0-054	3.27
701-0AS1-054	3.27
701-0AS4-054	3.27
701-0AT0-054	3.27
701-0AT1-054	3.27
701-0AT4-054	3.27
701-0B08-054	3.33
701-0B10-054	3.33
701-0BS0-054	3.27
701-0BS1-054	3.27
701-0BS4-054	3.27
701-0BT0-054	3.27
701-0BT1-054	3.27
701-0BT4-054	3.27
701-0C54-054	3.33
701-0C56-054	3.33
701-0C78-054	3.33
701-0C80-054	3.33
701-0CS0-054	3.29
701-0CS1-054	3.29
701-0CS4-054	3.29
701-0CT0-054	3.29
701-0CT1-054	3.29
701-0CT4-054	3.29
701-0D30-054	3.35
701-0D32-054	3.35
701-0D36-054	3.35
701-0D38-054	3.35
701-0DS0-054	3.29
701-0DS1-054	3.29
701-0DS4-054	3.29
701-0DT0-054	3.29
701-0DT1-054	3.29
701-0DT4-054	3.29
701-0US0-054	3.31
701-0US1-054	3.31
701-0US4-054	3.31
701-0UT0-054	3.31
701-0UT1-054	3.31
701-0UT4-054	3.31

Item number	Page
701-0VS0-054	3.31
701-0VS1-054	3.31
701-0VS4-054	3.31
701-0VT0-054	3.31
701-0VT1-054	3.31
701-0VT4-054	3.31
702-0A95-054	3.45
702-0A97-054	3.45
702-0AK0-054	3.37
702-0AK1-054	3.37
702-0AK4-054	3.37
702-0AL0-054	3.37
702-0AL1-054	3.37
702-0AL4-054	3.37
702-0B07-054	3.43
702-0B09-054	3.43
702-0BK0-054	3.37
702-0BK1-054	3.37
702-0BK4-054	3.37
702-0BL0-054	3.37
702-0BL1-054	3.37
702-0BL4-054	3.37
702-0C53-054	3.43
702-0C55-054	3.43
702-0C77-054	3.43
702-0C79-054	3.43
702-0CK0-054	3.39
702-0CK1-054	3.39
702-0CK4-054	3.39
702-0CL0-054	3.39
702-0CL1-054	3.39
702-0CL4-054	3.39
702-0D29-054	3.45
702-0D31-054	3.45
702-0D35-054	3.45
702-0D37-054	3.45
702-0DK0-054	3.39
702-0DK1-054	3.39
702-0DK4-054	3.39
702-0DL0-054	3.39
702-0DL1-054	3.39
702-0DL4-054	3.39
702-0EK0-054	3.47
702-0EK1-054	3.47
702-0EK4-054	3.47
702-0EL0-054	3.47
702-0EL1-054	3.47
702-0EL4-054	3.47
702-0FK0-054	3.47

Item number	Page
702-0FK1-054	3.47
702-0FK4-054	3.47
702-0FL0-054	3.47
702-0FL1-054	3.47
702-0FL4-054	3.47
702-0GK0-054	3.49
702-0GK1-054	3.49
702-0GK4-054	3.49
702-0GL0-054	3.49
702-0GL1-054	3.49
702-0GL4-054	3.49
702-0UK0-054	3.41
702-0UK1-054	3.41
702-0UK4-054	3.41
702-0ULO-054	3.41
702-0UL1-054	3.41
702-0UL4-054	3.41
702-0VK0-054	3.41
702-0VK1-054	3.41
702-0VK4-054	3.41
702-0VL0-054	3.41
702-0VL1-054	3.41
702-0VL4-054	3.41
728-1283	3.151
728-1284	3.151
728-1286	3.151
728-1287	3.151
729-0K71-054	2.15
825-7561	1.21
827-4013	1.10
827-4130	1.10
827-6201	1.10
827-6202	1.10
915-0007-050	3.71
915-0012-050	3.71
915-0032-050	3.71
915-0320	3.149
915-0X59	3.149
915-0Z85-050	3.71
915-0Z96-050	3.71
915-4175	3.149
915-4183	3.149
915-7016-380	3.71
915-7022-380	3.71
915-7105-050	3.71
915-7109-050	3.71
926-0A26-050	3.133
926-0A27-050	3.133
950-0T26-050	3.125

Item number	Page
950-0T27-050	3.89
951-0F15-650	2.17
951-0P59-050	2.15
951-0P63-050	2.15
951-0X94-050	2.15
954-0147-650	3.107
954-0148-650	3.109
954-0149-650	3.113
954-0153-650	3.107
954-0154-650	3.109
954-0158-650	3.111
954-0159-650	3.113
954-0164-650	3.61
954-0165-650	3.63
954-0168-650	3.111
954-0226-050	3.59
954-0227-050	3.59
954-0228-050	3.57
954-0229-050	3.57
954-0230-050	3.59
954-0B97-050	3.105
954-0B98-050	3.105
954-0B99-050	3.105
954-0C01-050	3.105
954-0C02-050	3.105
954-0C03-050	3.105
954-0E05-050	3.59
954-0E09-650	3.61
954-0E10-650	3.63
954-0E11-650	3.65
954-0E12-650	3.67
954-0E13-050	3.59
954-0E14-650	3.65
954-0E15-650	3.67
954-0E16-050	3.57
954-0E17-050	3.57
954-0U81-050	3.59
972-0X19	2.19
972-0X34	2.19
973-0M99	2.23
973-0X35	2.21
973-0X39	2.25
973-0X95	2.25
973-4125	2.25
973-4126	2.25
973-4451	2.21, 2.23
973-9018	2.27

Your authorized dealer